

YAMAHA

O2R

DIGITAL RECORDING CONSOLE

OWNER'S MANUAL

E

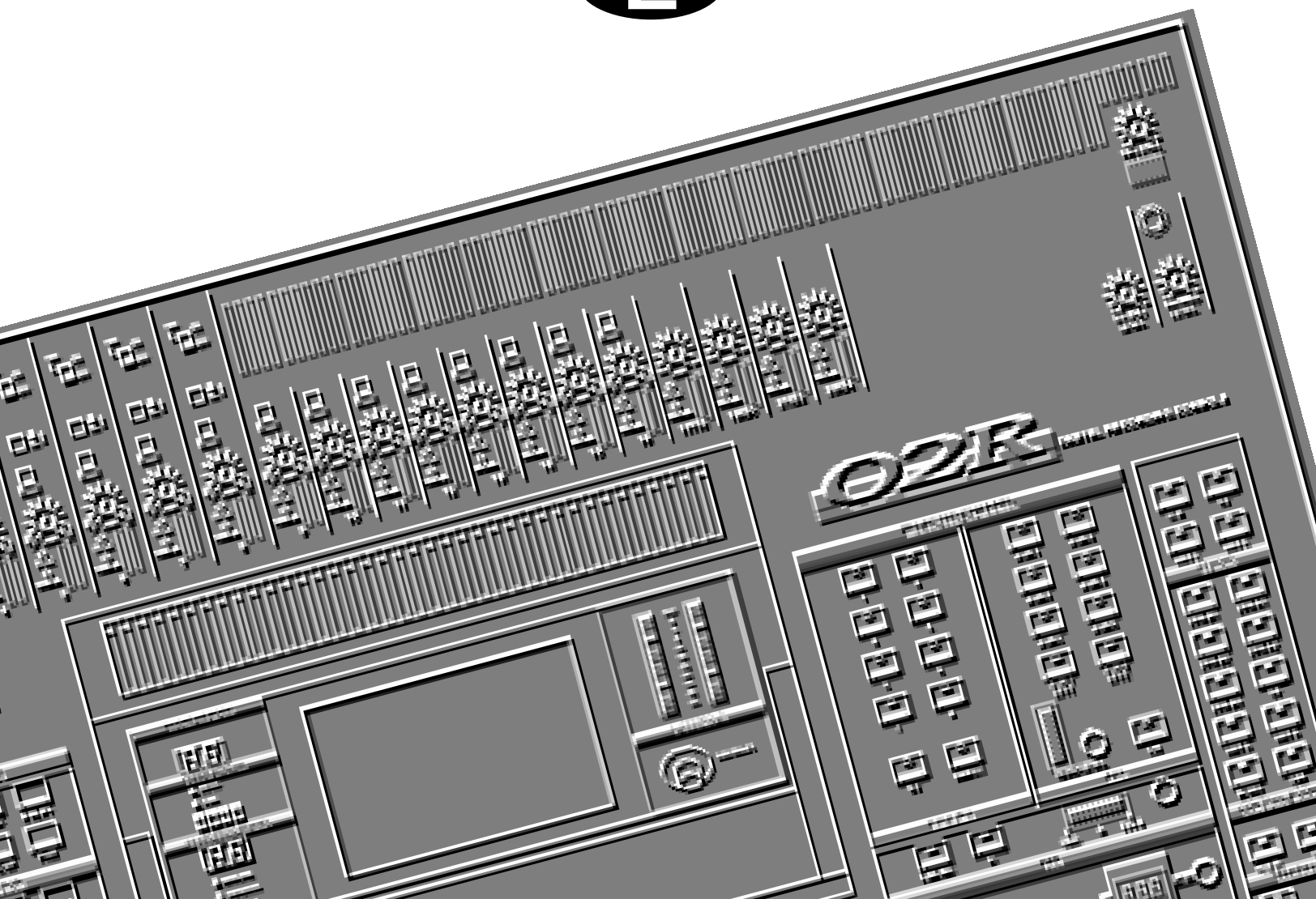

FCC INFORMATION (U.S.A.)

1. IMPORTANT NOTICE: DO NOT MODIFY THIS UNIT!

This product, when installed as indicated in the instructions contained in this manual, meets FCC requirements. Modifications not expressly approved by Yamaha may void your authority, granted by the FCC, to use the product.

2. IMPORTANT: When connecting this product to accessories and/or another product use only high quality shielded cables. Cable/s supplied with this product MUST be used. Follow all installation instructions. Failure to follow instructions could void your FCC authorization to use this product in the USA.

3. NOTE: This product has been tested and found to comply with the requirements listed in FCC Regulations, Part 15 for Class "B" digital devices. Compliance with these requirements provides a reasonable level of assurance that your use of this product in a residential environment will not result in harmful interference with other electronic devices. This equipment generates/uses radio frequencies and, if not installed and used according to the instructions found in the users manual, may cause interference harmful to the operation of other electronic devices. Compliance with FCC regulations does not guarantee that interference will not occur in all installations. If this product is found to be the source of interference, which can be determined by turning the unit "OFF" and "ON", please try to eliminate the problem by using one of the following measures:

Relocate either this product or the device that is being affected by the interference.

Utilize power outlets that are on different branch (circuit breaker or fuse) circuits or install AC line filter/s.

In the case of radio or TV interference, relocate/reorient the antenna. If the antenna lead-in is 300 ohm ribbon lead, change the lead-in to coaxial type cable.

If these corrective measures do not produce satisfactory results, please contact the local retailer authorized to distribute this type of product. If you can not locate the appropriate retailer, please contact Yamaha Corporation of America, Electronic Service Division, 6600 Orangethorpe Ave, Buena Park, CA 90620

* This applies only to products distributed by YAMAHA CORPORATION OF AMERICA.

IMPORTANT NOTICE FOR THE UNITED KINGDOM

Connecting the Plug and Cord

WARNING: THIS APPARATUS MUST BE EARTHED

IMPORTANT: The wires in this mains lead are coloured in accordance with the following code:

GREEN-AND-YELLOW	: EARTH
BLUE	: NEUTRAL
BROWN	: LIVE

As the colours of the wires in the mains lead of this apparatus may not correspond with the coloured markings identifying the terminals in your plug, proceed as follows:

The wire which is coloured GREEN and YELLOW must be connected to the terminal in the plug which is marked by the letter E or by the safety earth symbol or coloured GREEN and YELLOW.

The wire which is coloured BLUE must be connected to the terminal which is marked with the letter N or coloured BLACK.

The wire which is coloured BROWN must be connected to the terminal which is marked with the letter L or coloured RED.

* This applies only to products distributed by YAMAHA KEMBLE MUSIC (U.K.) LTD.

ADVARSEL!

Lithiumbatteri—Eksplodingsfare ved fejlagtig håndtering. Udskiftning må kun ske med batteri af samme fabrikat og type. Levér det brugte batteri tilbage til leverandoren.

VARNING

Explosionsfara vid felaktigt batteribyte. Använd samma batterityp eller en ekvivalent typ som rekommenderas av apparattillverkaren. Kassera använt batteri enligt fabrikantens instruktion.

VAROITUS

Paristo voi räjähtää, jos se on virheellisesti asennettu. Vaihda paristo ainoastaan laitevalmistajan suosittelemaan tyyppiin. Hävitä käytetty paristo valmistajan ohjeiden mukaisesti.

Important Information

Please read the following before operating your Digital Recording Console 02R.

Precautions

Installing the 02R

- The unit should be connected only to an AC receptacle of the type described in the owner's manual or as marked on the unit.
- Be careful to prevent the 02R from getting wet; do not allow water to enter the 02R, especially when raining or snowing, or near a body of water. Otherwise, fire or electrical shock may result.
- Do not block the ventilation holes on the 02R. The 02R has ventilation holes on the top, rear, front and bottom panel to prevent the inside temperature from rising. If the ventilation holes are blocked, the heat will remain inside, resulting in fire. In particular, avoid the following situations:

Do not orient the 02R upside down, face down, or sideways.

Do not place the 02R in a narrow, non-ventilated space, such as in a bookcase or closet. Use a dedicated rack.

- Do not place a table cloth on top of the 02R; do not place the 02R on a carpet or mattress.
- Do not place heavy objects on the power cord. If the cord is damaged, fire or electrical shock may result. In particular, it is possible that one might accidentally place a heavy object on the carpet that covers the cord, or place the 02R on top of a power cord; avoid these situations.
- To allow for the efficient release of heat, maintain a gap of 10cm or more between the rear of the 02R and the wall. Locate the 02R away from other equipment. If the release of heat is insufficient, the heat will remain inside the device, and result in a fire.
- Do not install the 02R in a place where it may be exposed to oil, smoke, or steam (for example, near a cooking table or humidifier). Otherwise, fire or electrical shock may result.
- Do not place the 02R on an unstable surface, such as an unstable bench or slanted surface. Otherwise, the equipment may fall or drop, resulting in injury.
- Do not place the power cord near a heating device. Otherwise, the cord sheath may melt, resulting in fire or electrical shock.
- Do not locate the 02R in a place subject to excessive heat, such as inside a car with all the windows closed, or in direct sunlight. Otherwise, fire may result.
- Do not place the 02R in a place subject to excessive humidity or dust. Otherwise, fire or electrical shock may result.

- Do not handle the power plug with wet hands. Otherwise, you may receive an electrical shock.
- When you remove the power plug, be sure to hold the plug. Never pull on the cord. Otherwise, the power cord will become damaged, resulting in fire or electrical shock.
- When relocating the 02R, since the 02R is heavy, make sure that two or more people carry it.
- When you are moving the 02R to another location, first turn off the power switch, remove the power plug from the AC outlet, and remove all cables connected to external devices. Otherwise, the cables may become damaged, resulting in fire or electrical shock.
- The Digital Recording Console 02R offers superb sonic quality. To ensure the best possible results, you should use the best quality connecting cables that you can afford. Regular maintenance involves keeping all connections clean using a quality contact cleaner.

Using the 02R

Do not touch the 02R under the following circumstances:

- If you hear thunder, turn off the power switch and remove the power plug from the AC outlet as soon as possible.

If you fear a lightning hit, and the 02R has been connected to an AC outlet, do not touch the power plug. Otherwise, you may receive an electrical shock.

- Do not attempt to modify this equipment. Otherwise, fire or electrical shock may result.
- Do not remove the case of the 02R. Otherwise, electrical shock may result.

If you think the 02R needs to be checked for maintenance or repair, consult your dealer.

- Do not place a container of water, or any small metal object on top of the 02R. If water is spilled or if the metal object falls inside, fire or electrical shock may result. This applies to vases, potted plants, glasses, cosmetic bottles, medicine, etc.
- Do not damage, process, bend, twist, stretch, or heat the power cord. Otherwise, the cord may be damaged, resulting in fire or electrical shock.
- When you are connecting audio devices or speakers to the 02R, make sure that first you turn off the power to all devices to be connected. Refer to the user's guide for each device, and use the specified cable for connection.
- Set the volume level on all the devices to the minimum before turning on the power. Otherwise, an extremely loud noise could damage your hearing.
- If you plan not to use the 02R for a long period of time (such as when you are on vacation), remove the power plug from the AC outlet. Otherwise, a fire could possibly result.

If an abnormality occurs while operating the 02, remove the plug from the AC outlet

- If you notice any abnormality--such as smoke, odor, noise, etc.--turn off the power to the 02R immediately, and remove the power plug from the AC outlet. Confirm that the abnormality is no longer present, then consult your dealer for repair. If you continue using the 02R under abnormal conditions, fire or electrical shock may result.
- If a foreign object or water enters inside the equipment, turn off the power to the 02R immediately, remove the power plug from the AC outlet, and consult your dealer for repair. If you continue using the 02R under this condition, fire or electrical shock may result.
- If the power cord is damaged (for example, the it is cut or if the core wire is exposed), ask your dealer for a replacement. If you continue using the 02R under this condition, fire or electrical shock may result.
- If the 02R is dropped, or the cabinet is damaged, turn off the power switch, remove the power plug from the AC outlet, and consult your dealer. If you continue using the 02R under this condition, fire or electrical shock may result.

Maintenance

- Before cleaning the 02R, remove the power plug from the AC outlet for safety. Otherwise, an electrical shock may result.
- An authorized dealer should clean the internal parts of the 02R on a regular basis. If you do not clean them for a long period of time, allowing dust to accumulate inside the equipment, fire or malfunction may result.

Consult your dealer about cleaning and its cost.

The optimum frequency for cleaning is once a year. It is especially effective to clean before a rainy or humid season starts.

- The performance of contact parts--such as switches, the volume encoder, and connectors--deteriorates with use. The degree of deterioration may differ depending on the environment, but the deterioration itself cannot be avoided. To replace the contact parts, consult your dealer.
- Do not apply oil, grease, or a contact repair agent to the faders. Otherwise, the conductivity of the electrical contact point may be affected.

If you think the faders' movement is awkward, refer to "User's Guide" on page 170 for calibration information.

Data backup

Data stored inside the equipment may be destroyed by malfunction or incorrect operation of the equipment. Be sure to save important data to an external MIDI device for backup.

Influences on other electrical devices

This equipment uses many digital circuits, which may cause noise to occur on nearby radio or TV. In this case, relocate the 02R away from those devices.

Exclusion of Certain Damages

Manufacturer, importer or dealer shall not be liable for any incidental or consequential damages for other than injury to the person and/or any other damages that caused by not proper use or operate the instrument.

Please, watch also our instructions in this manual.

Copyright

© 1995 Yamaha Corporation. All rights reserved.

No part of the Digital Recording Console 02R software or its user manuals may be reproduced or distributed in any form or by any means without the prior written authorization of Yamaha Corporation.

Trademarks

ADAT and Alesis are registered trademarks of Alesis Corporation.

ADAT Multichannel Optical Digital Interface is a trademark of Alesis Corporation.

TEAC[®] is a registered trademark of TEAC CORPORATION.

Tascam Digital Audio Interface (TDIF-1[™]) is a trademark of TEAC CORPORATION.

All other trademarks and registered trademarks are the property of their respective holders.

Package Contents

Your Digital Recording Console 02R package contains the following items. If you do not have them all, please contact your Yamaha dealer.

- Digital Recording Console 02R
- This *Getting Started Guide*

This Owner's Manual consists of:

- A Getting Started Guide section and
- A User's Guide section.



DIGITAL RECORDING CONSOLE

User's Guide

Contents

1	Introduction to the 02R.	1
	Digital Recording Console 02R.	2
	User Guides	3
	Installation	3
	Top and Rear Panels.	4
	Features.	5
	Key Features.	7
2	Getting Started	13
	Basic Assumptions	14
	Making the Connections	14
	Basic Setup	15
	Power ON/OFF.	16
	Setting the Synchronization.	16
	Recall Scene Memory 0.	17
3	Introductory Recording Tutorial	19
	Setting the Input Level.	20
	Applying EQ	24
	Using the EQUALIZER Library	30
	Routing	35
	Panning.	38
4	Secondary Recording Tutorial.	41
	Auxiliary Send Channels	42
	Setting the Auxiliary Send Level	43
	Creating a Monitor Mix	45
	Applying Effects	46
	Recalling and Editing Effects.	49
	Patching in a Dynamics Processor	54
	Using the Dynamics Library	57
	Scene Memories.	62

5	Mixing and Automation	67
	What is 02R Automation?	68
	Real-Time Automation	69
	Editing Automation Events	76
	Off-Line Automix Editing	81
	Using the AUTOMIX Library	86
	Index	90

1

Introduction to the 02R

In this chapter...

Digital Recording Console 02R	2
User Guides	3
Installation	3
Top and Rear Panels	4
Features	5
Key Features	7

Digital Recording Console 02R

From the company that pioneered digital mixing consoles and leads the industry with its acclaimed DSP technology comes the Digital Recording Console 02R – the most advanced digital mixing console in the world. All of YAMAHA’s experience and innovation has been applied to the 02R, to create a perfect mixer for use with the current generation of modular digital multitrack tape and disk recorders.

Inputs and Outputs – I/O Cards and Digital Cascade

With the YAMAHA Digital Recording Console 02R you can record and mix directly to your modular digital multitrack recorder without ever leaving the sonic purity of the digital domain. It is a 40 input channel mixer, each with full dynamic processing and 4-band parametric EQ, plus two stereo internal effects returns. It comes with 24 analog inputs, featuring 20-bit 64-times oversampling analog-to-digital conversion. By adding one of the optional digital I/O cards, you can also have 8 channels of direct digital input. Depending on configuration, up to four cards can be inserted into the 02R. The cards allow you to select from any of the currently used formats (ADAT®, TDIF™, YAMAHA, or AES/EBU). The optional cards allow you to route up to 16 outputs directly to your modular digital multitrack recorder. In addition, you can insert a Digital Cascade card into one of the I/O slots, allowing you to connect multiple 02Rs together to create a larger digital mixing system.

Dynamic Automation with Total and Instant Recall

The Digital Recording Console 02R is a fully dynamic automated mixing console – all referenced to time code. Its onboard automation system memorizes not just the faders, but a myriad of parameters. Switch individual channels on or off, adjust the equalization or the pan position, change the auxiliary send, and recall any scene memory – automatically. There are 64 internal scene memories which can store every digital mix parameter in a “snapshot” providing instant recall and reset.

Crystal Clarity and Unsurpassed Audio Quality

The 02R contains YAMAHA’s latest generation 32-bit proprietary audio DSP. All of your mix data is processed internally with 32-bit precision. Using the power of the latest generation effects processor chip, it also has a startling range of effects available: shimmering reverbs, clean, precise delays, flanging and chorus, and other effects are built into this mixer. It also features dynamics processors on all the inputs, allowing you to compress, limit, or gate the signals, giving you unparalleled sonic quality and flexibility. The 02R samples audio at 44.1 kHz and 48 kHz using its internal clock, and can sample at any frequency from 28 kHz to 53 kHz when an external word clock is applied.

RISC Technology

To provide powerful system control and full dynamic automation, the 02R is driven by a RISC technology CPU. With all this power and sonic quality, the 02R will become the heart of your digital recording studio.

User Guides

The Digital Recording Console 02R is supplied with an *Owner's Manual* which consists of two sections – a *Getting Started Guide* and a *User's Guide*. You should keep this manual handy for future reference.

Getting Started Guide

The *Getting Started Guide* sections contain a simple description and a couple of tutorials about digital recording with the 02R to get you started. It also has a tutorial on the automation system.

User's Guide

The *User's Guide* sections explain each 02R function in full detail. Use its table of contents to search for general topics and the index to search for specifics. A glossary of related terms is also provided.

Where to Start

If you are unfamiliar with the 02R, you should start with the *Getting Started Guide*. Read through the section and follow the steps outlined in the tutorials. Refer to the *User's Guide* when you are more familiar with the 02R and just need the details of how a particular function works. You may also want to refer to the *User's Guide* for more detailed information while using the *Getting Started Guide*.

Automation System

Regardless of your level of experience, you should read through the section "Mixing and Automation" on page 67 of the *Getting Started Guide*. The automation system built into the 02R is unique to this product. Even experienced recording engineers will want to refer to this section to discover how to record and playback entire mixing sessions. You should also refer to the section entitled "Automation" on page 123 of the *User's Guide*.

Installation

You should locate the Digital Recording Console 02R on a stable surface. It should be sited so that the display screen can be easily read from a comfortable position. Leave plenty of access space at the back of the unit to make the required connections to the other equipment in your digital recording studio.

Top and Rear Panels

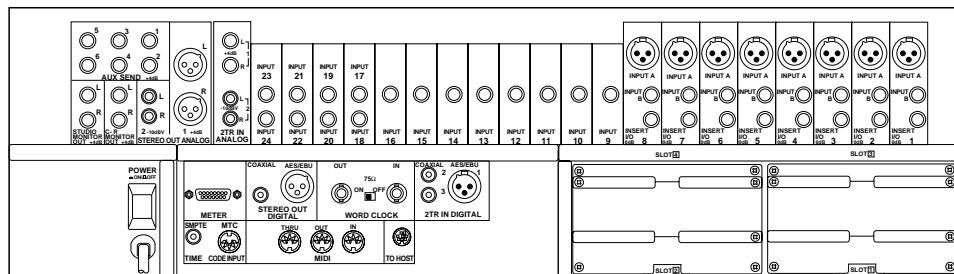
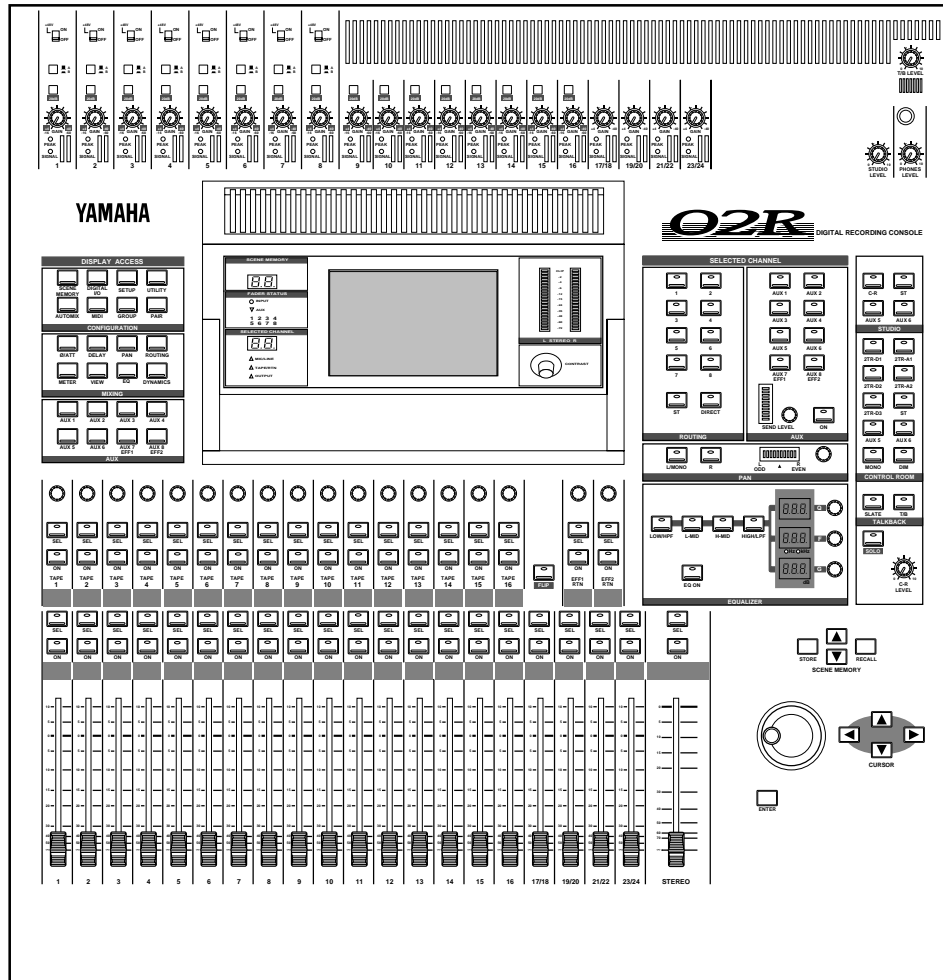

Features

Sonic Specifications

- Linear 20-bit 64-times oversampling A/D convertors
- Linear 20-bit 8-times oversampling D/A convertors
- 105 dB dynamic range (typical)
- 32-bit precision internal processing with a dynamic range of over 190 dB using YAMAHA's 32-bit proprietary audio DSP

General Features

- 40 input channel mixer, with full dynamic processing and 4-band parametric equalization
- Dynamic automation – all referenced to time code
- 64 internal scene memories for storing all digital mixer settings
- 4-band Parametric EQ with sweepable center-frequency from 20 Hz to 20kHz and adjustable bandwidth (Q)
- Extensive EQ library
- Comprehensive dynamics processors on each input channel, tape return, and buss and stereo output:
 - Compressor
 - Expander
 - Gate/Ducking
 - Soft and Hard Compander
- Dynamics library
- Fully programmable channel settings: phase and attenuation, delay, pan, routing, meters, EQ, and dynamics
- Channel library
- Two internal stereo effects using proprietary processor chip
- Effects library
- 8 output busses, 8 auxiliary send busses, and main stereo mix buss
- 24 balanced analog inputs (8 channels with either XLR-type or phone connectors)
- Continuously variable gain control
- 20 dB input pad
- 8 XLR-type inputs with 48V phantom power for condenser microphones
- 8 analog insert input/output connections
- 2 analog 2TR IN inputs

- 2 analog stereo outputs
- 6 analog auxiliary send outputs
- Stereo studio and control room outputs
- 3 digital 2TR IN inputs
- 2 digital stereo outputs
- Industry standard AES/EBU or IEC958 Part2 (Consumer) digital inputs and outputs
- 100mm motorized faders
- Fader and mute groups for single fader or button control over several faders or channel ON buttons
- Adjacent channel pair function for stereo operation on inputs, tape returns, and auxiliary channels
- Dedicated buttons and controls of the Selected Channel module
- Large 320 × 240 pixel, FL-backlit, user-friendly graphical display screen
- RISC technology CPU
- SMPTE and MTC synchronization plus full MIDI implementation

Optional Features

- Optional digital I/O cards:
 - Alesis ADAT
 - TASCAM TDIF-1
 - YAMAHA
 - AES/EBU
 - Digital Cascade
- Optional analog input/output card
- Optional 1MB memory expansion kit
- Optional meter bridge
- Optional wooden side panels

Key Features

This section looks at some of the key features of the Digital Recording Console 02R, what they mean to you, and some hints about how you can use them.

Dynamic Automation

One of the most demanding jobs of the recording engineer is taking all the raw material produced during a multitrack recording session and mixing it all together into an artistically satisfying master recording. The ability to setup portions of the mix and then have them playback automatically as you work on other portions is probably the most important feature of the Digital Recording Console 02R.

It has an on-board automation system that memorizes fader positions, switches individual channels on or off, adjusts the equalization or pan positions, and changes the auxiliary sends – all based on time code. It can also record and execute scene memory changes, also determined by time code. This allows you to perform an entire mixing session, and then edit individual channel settings until you have achieved the perfect mix.

The 02R allows you to record a mixdown in real-time and then edit the results, either in real-time or by using one of the event editors. You can select single parameters of the mixer to edit – for example, just enable the faders for one pass as you create your mixdown.

Scene Memories

The 02R has 64 internal scene memories each of which is a snapshot of all the digital settings of the mixer (a mix scene). Each can be named for easy identification. They can be stored and later recalled instantly.

If you work on several projects at one time, you can store the current mixer settings in a scene memory so when you return to that project, you can start immediately from where you left off. When you are working on a mixdown, the ability to recall mixer scenes can speed the process and allows for accurate repetition of the various parts of the mix. When you use the 02R for sound reinforcement applications, the ability to recall mix scenes can make light work of night-after-night sound checks.

Storing the mixer settings to a scene memory is a simple matter of pressing the [STORE] button and confirming the request.

Note: *You can customize your 02R to perform the storage operation without confirmation. See “Preferences” on page 162 of the User’s Guide for more details.*

Recalling the scene is even easier – just press the [RECALL] button. You should be careful that your scene memories flow into each other smoothly. The instant recall means that you can have very abrupt level changes or the unexpected intrusion of a very loud channel.

Note: *The 02R allows you to have programmable fades between scene memories. The only thing you need to watch is the sudden sound of a channel being switched on. Even then, if the original channel level was set to $-\infty$ dB, you should have no problems. See “Fade Time” on page 121 of the User’s Guide.*

Large Graphical Display

The heart of the 02R user interface is the large graphical display located in the center of the console. Using the Display Access controls, you can gain immediate access to the features of the mixer – clearly displayed on the 320 × 240 pixel, FL-backlit, user-friendly graphical display screen. Virtual control modules are shown on the screen, allowing you to adjust almost any digital parameter anywhere in the system.

As well as displaying parameter values numerically, faders, rotary controls, and push buttons are represented graphically, so you can actually see button status, pan positions, and fader levels.

In addition the equalization curves are displayed graphically as are the dynamics processor parameters.

User Interface

The Digital Recording Console 02R user interface is powerful but very intuitive. There are two main methods of working with the 02R:

- Use the DISPLAY ACCESS controls to modify one parameter at a time across the entire recording console.
- Use the SELECTED CHANNEL controls to modify all of the parameters of the currently selected channel.

The DISPLAY ACCESS controls consist of a block of 24 function buttons divided into three groups – the CONFIGURATION group, the MIXING group, and the AUX group – plus the large backlit graphical display screen, four cursor buttons, a detented encoder wheel, and the [ENTER] button. There is also a related block of four SCENE MEMORY buttons – to increment, decrement, store, and recall the scene memories.

The SELECTED CHANNEL controls consist of four main blocks of controls – each block was designed to be as familiar as the equivalent controls on a standard analog mixer, but with the power of digital precision and instant recall. The ROUTING block selects the buss onto which to route the current channel signal. The AUX block selects the auxiliary buss to send the channel signal to and sets the send level. The PAN block sets the pan position of the channel signal. The EQ block sets the equalization curve for

the current channel. You can customize your 02R to automatically select the corresponding display function when you adjust a control in these blocks.

Motorized Faders

In addition to the DISPLAY ACCESS and SELECTED CHANNEL controls, each input channel and the stereo master channel utilizes a 100mm motorized fader. When a scene memory is recalled, the faders position themselves automatically to the levels stored. Fader movements are replayed automatically in synchronization with time code during playback of a dynamic automation memory.

The faders allow you to quickly and accurately set the levels for the selected channels. By pressing the [FLIP] button, you can transfer fader control over your tape returns as well. Faders can be grouped into one of four fader groups for control of multiple faders from a single control. (There are also four mute groups which allow you to toggle a group of channels on or off.) You can also control two adjacent channels in stereo with the pair operation using only one fader.

Internal Stereo Effects

The Digital Recording Console 02R features eight auxiliary sends, two of which are routed to the internal multi-effects stereo processors: Effect1 and Effect2. Using the power of YAMAHA's proprietary effects processor chip, the 02R has a startling range of special effects available to apply to your mix. Shimmering reverbs, clean and precise delays, flanging and chorus, and a myriad of other effects are available built right into this mixer. The effects are processed entirely within the digital domain, ensuring the signal quality is the finest that a digital system can provide.

The 02R features a simple and convenient analog interface to outboard signal processing and effects units. When you use the six auxiliary sends, the signal from those channels is converted to analog at 18-bits linear, 8-times oversampling.

Effects can be applied to input channels or the tape return channels, and the auxiliary sends can be configured pre-fader or post-fader. There are 40 preset effects programs and 88 user effects programs for you to store your own settings.

Dynamics Processors

Dynamics processors are generally used to correct or control signal levels. However, you can also use them creatively to shape the volume envelope of a sound. The 02R features comprehensive dynamics processors for all the input, return, buss, and stereo output channels – a total of 50 processors. These processors allow you to compress, expand, limit, gate, or duck the signals passing through the mixer, giving you unparalleled sonic quality and flexibility.

Similar to the internal stereo effects, the dynamics processors are patched directly into the signal path while the audio data remains in the digital domain. Signal quality is unaffected by conversion to and from digital as would be the case if you used an external dynamics processor. The dynamics program settings are stored in the dynamics library as well as the scene memory. There are 40 preset programs for you to recall and 88 user programs for you to store your own dynamics programs

Parametric EQ with Library

The Digital Recording Console 02R contains a high-performance four-band, fully parametric equalizer. Each input channel, tape and effect return, and the stereo output channel features an equalizer. You can tailor the equalization curve with a high degree of precision, covering the entire dynamic spectrum from 21 Hz to 20.1 kHz. Select the center-frequency (F) and adjust the bandwidth (Q) and the gain (G) until you have achieved the perfect sound.

The EQ setting for each channel is stored in the scene memory and can be adjusted in real-time with the dynamic automation system. The 02R also has an extensive EQ library which allows you to store frequently used equalizer settings for instant recall. An equalization program stored in the EQ library is a good starting point and reference when making adjustments to the equalization.

Digital Benefits

You're probably already familiar with the many benefits of digital audio, but what exactly are the benefits for digital audio mixing?

An audio mixer has the job of combining audio signals from various sources, at differing levels and impedances, usually into a stereo signal. It must do this without introducing any new distortions and noise. Most analog mixers do a pretty good job, but even with the best designs, nonlinear effects caused by circuit components are unavoidable.

In the digital realm, audio mixing consists of adding and multiplying the binary numbers that represent audio signals. The 02R uses a 32-bit DSP (Digital Signal Processor) chip for these calculations, ensuring a very high degree of precision. Once past the analog-to-digital conversion, audio signals are essentially immune from standard signal degradation. With the 02R, noise, distortion, and crosstalk are virtually eliminated. You'll hear a new clarity in your mixes.

Once in the digital realm, there's little point converting back to analog. The 02R features stereo digital outputs for direct mixdown to DAT and other digital recorders. It uses the industry standards AES/EBU or IEC958 Part2 (Consumer) for its digital inputs and outputs. With one of the optional digital I/O cards installed in your 02R, you can record direct-to-digital to your modular digital multitrack recorder.

Digital Recording Console 02R Sonic Performance

The Digital Recording Console 02R uses linear 20-bit 64-times oversampling analog-to-digital converters to provide a typical dynamic range of 105 dB. This means that an audio program's dynamic range, from low to high levels, is processed intact. The 02R samples audio at 44.1kHz, the commercial sampling rate for compact discs, and at 48kHz, the professional sampling rate. It provides a full spectrum frequency response of 20 Hz to 20 kHz +1, -3 dB.

For digital-to-analog conversion, the 02R features 20-bit 8-times oversampling for its main stereo outputs, including the control room monitor outputs, and 18-bit 8-times oversampling for the studio and auxiliary send outputs. Oversampling and bitstream techniques effectively increase the internal sampling rate, so side effects caused by steep low-pass filters, which are used to filter out undesirable sampling frequency components during digital-to-analog conversion, are virtually eliminated.

Consequently, audio signal integrity is maintained from input through to output.

2

Getting Started

In this chapter...

Basic Assumptions	14
Making the Connections	14
Basic Setup	15
Power ON/OFF	16
Setting the Synchronization	16
Recall Scene Memory 0	17

Basic Assumptions

The Digital Recording Console 02R was designed to be the perfect digital mixing console for a studio using the current generation of modular digital multitrack tape and disk recorders. Although the 02R can also be used as a sound-reinforcement mixer, the typical user will own a project recording or post-production studio with some form of multitrack recorder. Therefore, your 02R will probably be equipped with one or more of the optional input/output cards. For the purposes of these tutorials, it does not matter if you are working with an analog or digital multitrack.

What You Will Need

To perform the following tutorials, you will need:

- The 02R.
- A sound source: CD player, drum machine, synthesizer/sequencer with demo song.
- Amplifiers and speakers, or headphones.
- A multitrack recorder and a stereo master recorder.
- Audio connecting cables.

Making the Connections

WARNING! *Before making any connections, make sure that all your equipment is powered OFF.*

1. Connect your sound source to input channel 1.

If you are using a stereo sound source, connect it to input channel 2 as well. A stereo source is not essential, and for most of the tutorials it will probably be easier to work with just one channel. If your sound source has XLR-type connectors, connect it to the XLR-type connectors on the 02R. Otherwise, use the phone jacks and select INPUT B with the [A/B] switch.

2. Connect the C-R MONITOR OUT connectors to the inputs on your power amplifier.

If you are using headphones, connect them to the PHONES jack.

3. Connect your multitrack recorder to the appropriate optional input/output card.

You can also connect your stereo master recorder to either the digital or analog STEREO OUT connectors.

4. Plug the 02R into a suitable AC receptacle.

WARNING! *The Digital Recording Console 02R should be connected only to an AC receptacle of the voltage type marked on its rear panel.*

Basic Setup

The following illustration shows how to set up a minimal system that will allow you to perform the following tutorials.

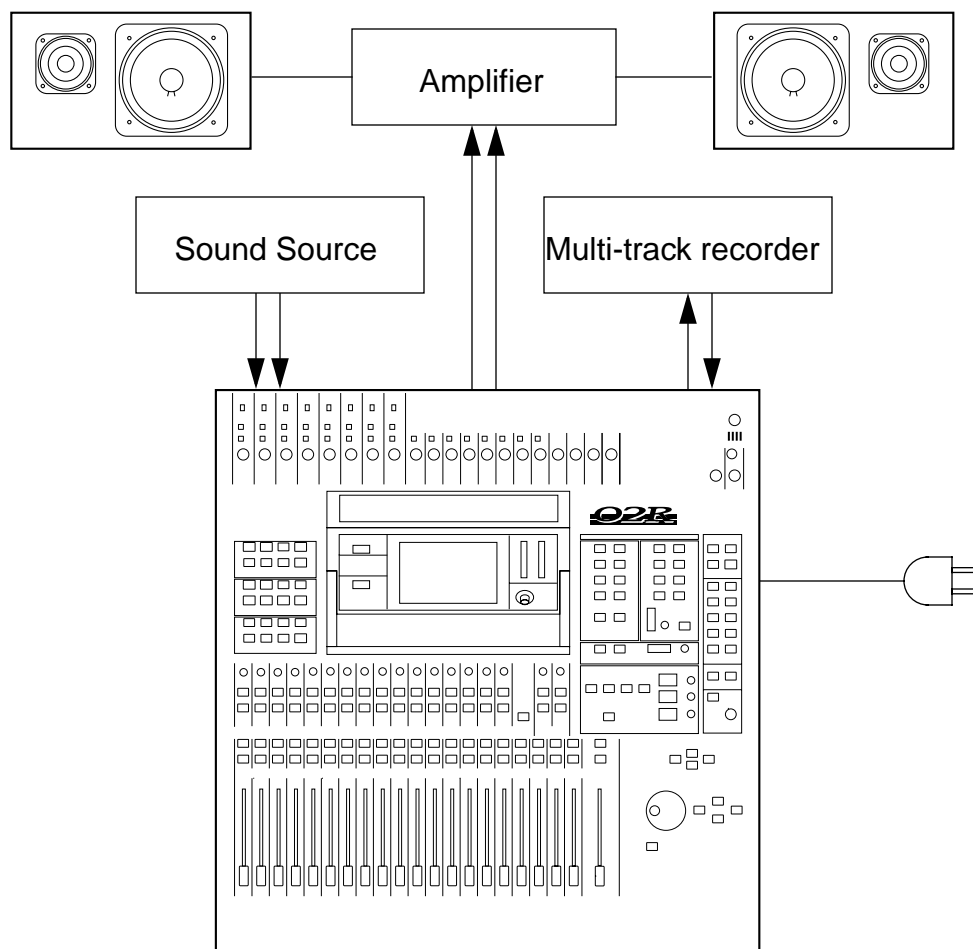

Power ON/OFF

This section explains how to power the Digital Recording Console 02R on and off.

Power ON

It is always important to observe the correct order for powering up equipment in a studio. Always start with the multitrack and mastering recorders and the signal processors, then the 02R, and finally the monitoring amplifiers and other downstream gear.

POWER
ON/OFF

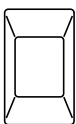

1. **Turn ON the power to the 02R by pressing the POWER switch on the back panel.**

The 02R start-up screen appears for a few seconds, the faders initialize themselves, then the screen that was used when the 02R was last powered off appears.

Power OFF

It is always important to observe the correct order for powering up equipment in a studio. Always start with the monitoring amplifiers and other downstream gear, then the 02R, and finally the multitrack and mastering recorders and the signal processors.

1. **Turn OFF the power to the 02R by pressing the POWER switch on the back panel.**

All mix settings, mix scenes, and other data are stored when the 02R is powered off.

Setting the Synchronization

Before you use the 02R with a modular digital multitrack recorder or DAT master recorder, be sure to correctly set the synchronization. The 02R must be slaved to an external wordclock in order to process the input digital signals without drop-out or distortion. Refer to the section “Word Clock Select” on page 154 of the *User’s Guide*.

Look in the chapter “Installing Options” on page 171 of the *User’s Guide*. There is a section for each of the optional digital I/O cards that the 02R supports. Refer to the appropriate section for the card installed in your unit.

Recall Scene Memory 0

Before you start the tutorials, you should set the 02R to its initial mixer settings.

2. Use the SCENE MEMORY increment or decrement buttons to select scene memory 0 “0 Initial Data”.

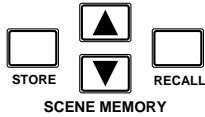

3. Press the (RECALL) button.

This is a read-only scene memory that contains the default settings for the system. The 02R will be reset to its initial settings.

Note: *It is best to start at the beginning of each tutorial and work your way through, taking breaks as required. If you deviate too far from the tutorial, or jump into a tutorial halfway through, you may find that subsequent tutorial steps do not work as expected. Also note that the tutorials do not explain all Digital Recording Console 02R functions, nor do they serve as a substitute for the User’s Guide explanations. For full details on all 02R functions, refer to the User’s Guide.*

3

Introductory Recording Tutorial

In this chapter...

Setting the Input Level	20
Applying EQ	24
Using the EQUALIZER Library	30
Routing	35
Panning	38



Setting the Input Level

Assuming that Digital Recording Console 02R is powered ON and your music source is playing, the very first thing you need to do is set up a basic control room monitor mix. When you recall Scene Memory 0 "0 Initial Data", all the channel faders are set to the 0 dB mark.

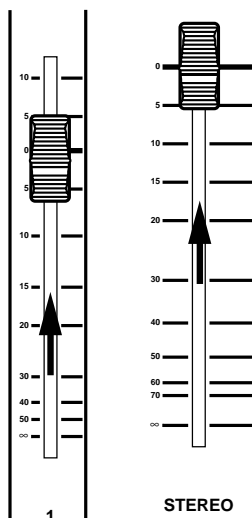

Setting Fader Levels

If the faders are not set to 0 dB, you should perform the following steps to optimize the input signal level for the best performance:

- 1. Set the fader for MIC/LINE 1 to the 0 dB mark.**

The 0 dB fader position is a good place to start when setting fader levels. It is a good setting with regard to signal level and noise performance and it leaves room for you to raise the level later, if necessary.

- 2. Set the STEREO fader to the 0 dB mark.**

The stereo output meters are indicating the stereo output level. The stereo mix signal is now being output to the digital and analog STEREO OUT connectors.

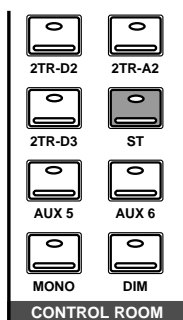

Selecting a Monitor Source

Before you can hear anything through your monitor amplifier and speakers, you have to select a Control Room source:

- 1. Press the (ST) button of the CONTROL ROOM buttons group.**

This selects the stereo bus for monitoring in the control room.

- 2. Adjust the volume with the C-R LEVEL control.**

You should be able to hear the sound source through your monitor speakers. If you are using stereo headphones, you will need to adjust the PHONES LEVEL control to set a comfortable listening level.



Note: *Be very careful with the level settings, especially if you are using stereo headphones. When you are adjusting a unit as complex as the Digital Recording Console 02R, it is possible for you to inadvertently switch on a very loud signal source. Damaged loudspeakers or amplifiers can be very expensive. Damage to your hearing can be much worse. Your ears are for life!*

Setting the GAIN



1. Press the (METER) button.

The METER Display function appears showing the signal level for MIC/LINE 1.

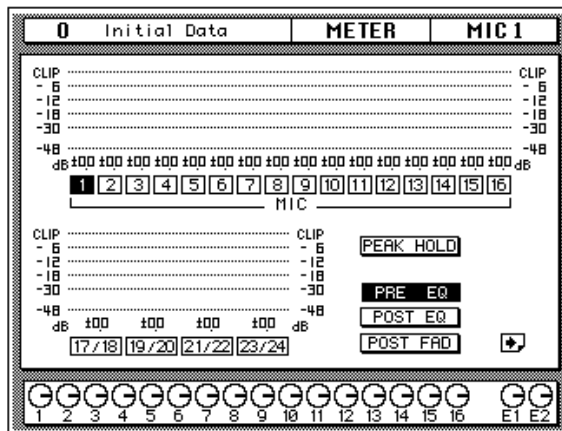

2. Press the (SEL) button for MIC/LINE 1.

You are now monitoring the input channel MIC/LINE 1.



3. If the sound is distorted, the PEAK indicator is illuminated, or the level is going up to CLIP, press the 20dB (pad) switch to attenuate the input signal for MIC/LINE 1.

You usually need to pad (attenuate) the input signal when you connect a line level device, such as a synthesizer or an effects unit to the channel. If you connect a microphone, you should not need to pad the signal.

If you want to use a very high impedance device, such as a guitar or bass guitar, you should insert a direct box or effects processor between the guitar and the 02R – or you should mike the guitar amplifier.

Note: The stereo input channels (LINE 17 through 24) accept line level signals only.

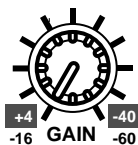

4. Use the GAIN control for MIC/LINE 1 to optimize the signal level.

Ideally the level should be set relatively high to obtain the best signal-to-noise performance. It is acceptable for the PEAK indicator to occasionally illuminate but the signal levels should not reach CLIP. If the PEAK indicator illuminates constantly, the signal is overloading the input preamplifier and you may be able to hear analog clipping distortion. When CLIP is reached, you will experience digital clipping distortion, which is usually very unpleasant sounding.

Back off the GAIN control a little until the PEAK indicator illuminates very occasionally. The GAIN control should be set with some care. If it is set too low, the signal-to-noise performance will suffer, and if it is set too high, signal clipping and distortion may occur.

∅/ATT Display Function

The signal level may be too high in the digital domain. If CLIP is reached, but the corresponding PEAK indicator is not illuminated, you need to attenuate the channel slightly with the ∅/ATT display function.



1. Press the (∅/ATT) button.
2. Use the CURSOR buttons to select the attenuator icon for MIC/LINE 1 and rotate the encoder wheel to adjust the attenuation level.

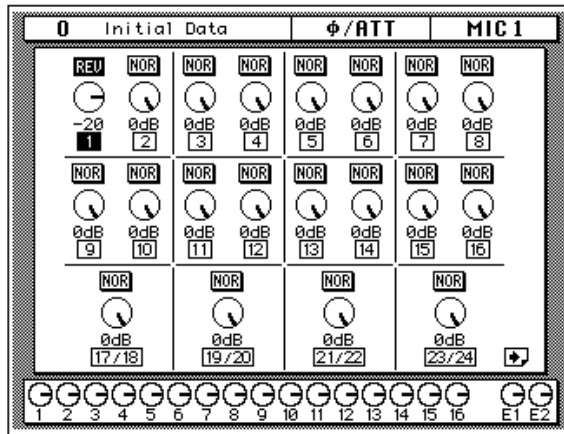

The ∅/ATT display function allows you to attenuate (and invert the phase) of a signal after it has been converted to digital data.

Note: You should rarely find it necessary to use the ∅/ATT function on an input signal after the gain level has been correctly set, but you may need to attenuate after you apply equalization, effects, or dynamics to the signal.

Peak Hold



1. If you used the ∅/ATT display function, press the (METER) button again.

The 02R will return to the METER display function.

2. You may find the Peak Hold function useful at this point. To turn it on, use the CURSOR buttons to select the PEAK HOLD control icon and press (ENTER). When the Peak Hold function is active, the control icon is displayed in reverse video.

The peak level is indicated by an empty square box. Peak Hold is very useful for level checking before recording. You can leave a mix to play through unattended while Peak Hold watches out for signal peaks. If any levels reach CLIP, back off the relevant GAIN control or use the \emptyset /ATT display function to attenuate the signal and run through the mix again.

Note: *The Peak Hold function also works on the stereo output meters and controls the optional meter bridge (MB02).*

3. To clear the Peak Hold levels, select the PEAK HOLD control icon with the CURSOR buttons and press (ENTER).

When you clear the Peak Hold levels, it also clears the peaks from the stereo output meters.

Typically, you will be using more than just one input channel, so you will need to set the input signal level for each channel individually. Since it is relatively easy to set them at this point, take time and care. If you have to adjust them later in the mixing process, you may need to adjust the faders, auxiliary sends, and other levels, as well.

Channel ON/OFF

The channel [ON] buttons are used to turn channels ON or OFF. This function is sometimes called MUTE. When you recall Scene Memory 0 “0 Initial Data”, all the channels are turned ON.



1. Press the channel (ON) button for MIC/LINE 1.

The sound is cut and the LED inset in the [ON] button switches off.

Note: *Even though you can no longer hear the sound source, the meter for MIC/LINE 1 continues to be displayed on the screen. This is because the meter signal is sourced before the [ON] button.*

2. Press the (ON) button again to turn the channel back ON.

The LED inset in the [ON] button illuminates again and you will be able to hear the sound source again.

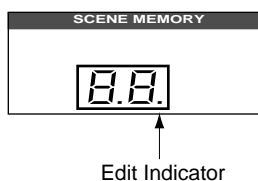

SCENE MEMORY LED

The 2-digit (7-segment) LED shows the currently selected SCENE MEMORY program. It also contains the Edit Indicator, which will start flashing when you adjust the first digital parameter of the current scene memory. See “Scene Memories” on page 62 of the *Getting Started Guide*.

Applying EQ

The next step is to apply equalization to MIC/LINE 1.

The Digital Recording Console 02R has a four-band fully parametric equalizer, with variable bandwidth (Q), frequency (F), and gain (G). The power of the 02R user interface means that there are two ways of adjusting the equalization for MIC/LINE 1.

One method is to use the EQUALIZER display function.

The more convenient method is to use the buttons and controls of the EQUALIZER block of the SELECTED CHANNEL controls.

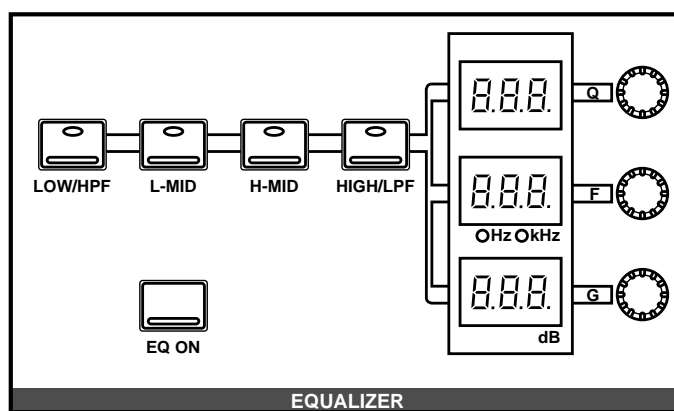

Note: You can customize your 02R so that when you adjust a control of the EQUALIZER block of the SELECTED CHANNEL controls, the EQUALIZER display function automatically appears on the screen. See “Preferences” on page 162 of the User’s Guide for more information. The default setting is to automatically display the EQUALIZER screen.

This tutorial will describe the operation of the EQUALIZER display function, even though it will be immediately obvious to you that using the dedicated buttons and controls of the EQUALIZER block of the SELECTED CHANNEL group is the more convenient method. The purpose of this tutorial is to show you how to use the 02R.

For consistency, the tutorials will focus on the display functions, but you should use the dedicated controls of the SELECTED CHANNEL group as much as you can.

Turning the Equalizer ON/OFF



1. Press the (SEL) button for MIC/LINE 1.

When you press the [SEL] button for a channel, the LED and numeric indicators of the SELECTED CHANNEL controls change to reflect the status of the channel you pressed.



2. Press the (EQ) button.

The EQUALIZER display function appears showing the equalization curve and settings for MIC/LINE 1.

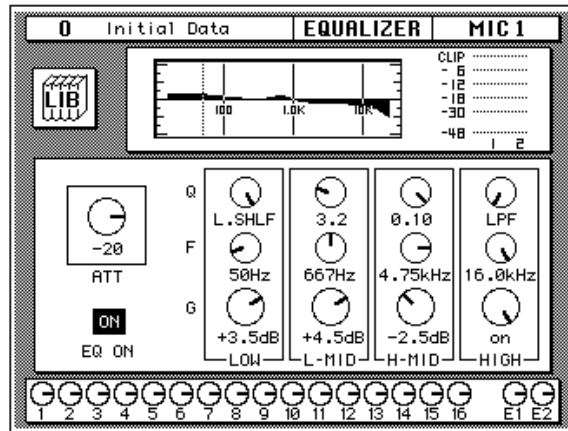

3. Use the CURSOR buttons to select the EQ ON icon.

If the equalizer is ON, the icon will be highlighted in reverse video. The LED inset in the [EQ ON] button of the SELECTED CHANNEL – EQUALIZER block controls will also be illuminated.

4. To switch the status of the EQ, either press the (ENTER) button or the (EQ ON) button.

The ON icon will change to OFF and will no longer be displayed in reverse video. The LED inset in the [EQ ON] button will no longer be illuminated.

If you turned the equalizer OFF, switch it ON again.

Setting the Gain

1. Select the gain (G) icon for the LOW band using the CURSOR buttons.

The icon will be surrounded by a flashing grey box, indicating that this is the active element on the screen. Alternatively, you can press the [LOW/HPF] button of the SELECTED CHANNEL – EQUALIZER controls.

2. Rotate the encoder wheel clockwise to boost the gain.

You can also adjust the “G” rotary encoder of the EQUALIZER controls to achieve the same effect.

The gain increases in 0.5 dB steps and the EQ curve on the display changes to reflect this.

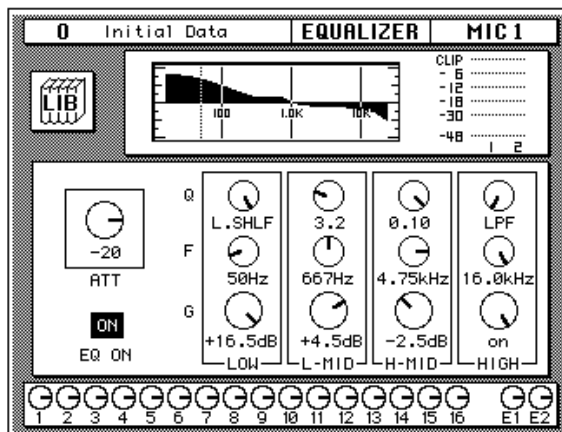

3. Rotate the encoder wheel counterclockwise to reduce the gain.

You can also adjust the “G” rotary encoder to reduce the gain. The gain decreases in 0.5 dB steps.

4. Use the CURSOR buttons to select the gain (G) icon for the L-MID band and adjust its level with the encoder wheel. Select the other bands as well.

You can also select the different bands using the [L-MID], [H-MID], and [HIGH/LPF] buttons of the SELECTED CHANNEL – EQUALIZER controls.

Note: *Applying a lot of EQ boost may increase the signal level sufficiently to cause distortion. If this does occur, reduce the amount of EQ boost or adjust the attenuation level to compensate (the ATT control icon). You can switch back to the METER display function and select POST EQ to monitor the signal levels.*

Note: *You can reset the gain of each band to 0.0 dB by double-clicking the corresponding [LOW/HPF], [L-MID], [H-MID], or [HIGH/LPF] buttons of the SELECTED CHANNEL – EQUALIZER controls.*

Setting the Frequency

1. Select the frequency (F) icon for the LOW band using the CURSOR buttons.
2. Use the encoder wheel to sweep through the frequency range.

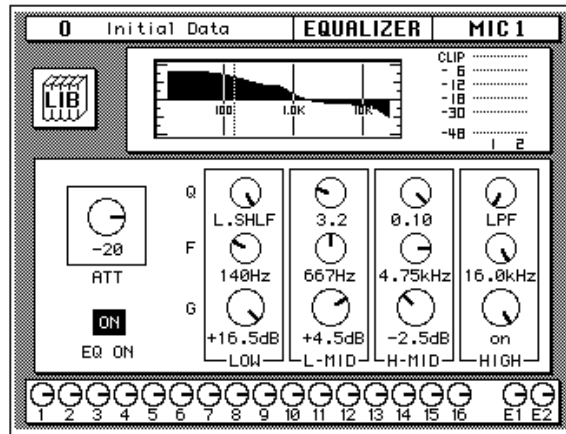

You can also adjust the “F” rotary encoder of the EQUALIZER controls to achieve the same effect.

All four bands of the O2R parametric equalizer cover virtually the entire audio spectrum, from 21 Hz to 20.1 kHz. Although they are labelled LOW, L-MID, H-MID, and HIGH, the frequency of the bands can actually be in any order.

Note: If your O2R is busy processing some complex data, it may take a little while to draw the equalization curve. However, the internal EQ circuits reflect your adjustments immediately.

Note: As well as the frequency value in Hz displayed under the icon and on the numeric LED in the SELECTED CHANNEL – EQUALIZER controls, the dotted vertical line on the EQ graph indicates the current frequency position.

3. Use the CURSOR buttons to select the frequency (F) icon for the L-MID band and adjust its position with the encoder wheel. Select the other bands and adjust their frequency.

You can also select the different bands using the [L-MID], [H-MID], and [HIGH/LPF] buttons of the SELECTED CHANNEL – EQUALIZER controls. Adjust the “F” rotary encoder for each band.

Setting the Bandwidth

The L-MID and H-MID bands are peaking type equalizers. The LOW and HIGH bands are initially configured as shelving type equalizers, however, they can also be configured as peaking type equalizers. The LOW band can also be configured as a HPF (high-pass filter) and the HIGH band as a LPF (low-pass filter).

1. **Select the bandwidth (Q) icon for the LOW band using the CURSOR buttons.**
2. **Use the encoder wheel to sweep through the bandwidth.**

You can also adjust the “Q” rotary encoder of the EQUALIZER controls to achieve the same effect.

The LOW band changes from low-shelving to peaking to high-pass filter as you continue to rotate the encoder wheel.

3. **As you rotate the encoder wheel counterclockwise, it effectively increases the Q – narrowing the bandwidth, as shown on the EQ graph.**

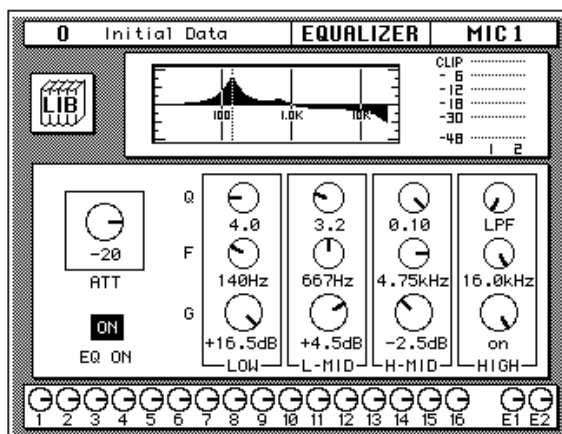

A narrow curve is useful for boosting or cutting specific frequencies.

4. **Use the CURSOR buttons to select the bandwidth (Q) icon for the L-MID band and adjust its position with the encoder wheel. Select and adjust the bandwidth of the other bands.**

You can also select the different bands using the [L-MID], [H-MID], and [HIGH/LPF] buttons of the SELECTED CHANNEL – EQUALIZER controls. Adjust the “Q” rotary encoder for each band.

The HIGH band changes from high-shelving to peaking to low-pass filter as you adjust its value.

Resetting the Equalizer

1. Press and hold the (LOW/HPF) button and then press the (HIGH/LPF) button of the SELECTED CHANNEL – EQUALIZER controls.

All equalizer values will be reset to their defaults.

	LOW/HPF	L-MID	H-MID	HIGH/LPF
Q	LOW SHELF	Peak – 0.7	Peak – 0.7	HIGH SHELF
F	125 Hz	1.00 kHz	4.00 kHz	10.0 kHz
G	0 dB	0 dB	0 dB	0 dB

Using the EQUALIZER Library

The Equalizer Library is used to access and store EQ settings – stored as programs. There are 32 preset programs (1 to 32) for you to recall and 96 user programs (33 to 128 plus UNDO) for you to store your own EQ settings. First you need to know how to recall EQ programs, then how to store your own.

Note: *The programs 33 to 40 contain preset programs and are listed in the “Equalizer Programs” on page 52 of the User’s Guide. However, you can store your own setting to these programs.*

Recalling an EQ Program



1. Press the (EQ) button. Select the LIB icon with the CURSOR buttons and press the (ENTER) button.

A faster method of selecting the EQUALIZER Library display function is by pressing the [EQ] button a second time.

The EQUALIZER Library display function appears on the screen.

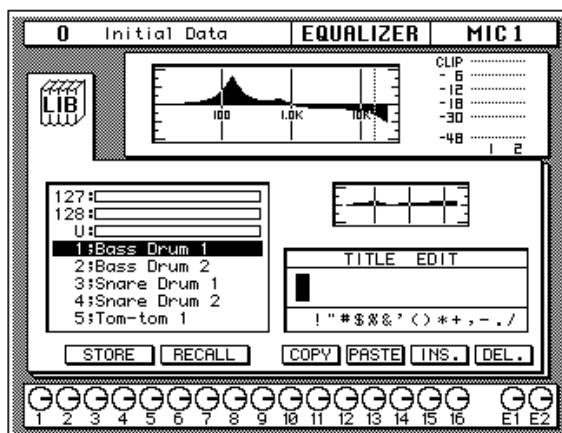

The top of the display shows the current equalization curve for the selected channel and a level meter for the channel and its adjacent pair.

2. Press the (SEL) button for MIC/LINE 1.

This step is only necessary to make sure you are still working with the same channel you started with.

3. Select the RECALL icon with the CURSOR buttons.

In order to scroll through the list of EQ programs, the cursor must be on the STORE, RECALL, COPY, or PASTE icons.

4. Use the encoder wheel to select an EQ program.

As the 02R scrolls through the list of EQ programs, a small diagram of the response curve of the highlighted EQ program is shown to the right of the list.

5. Press the (ENTER) button.

The EQ program is recalled. The equalization curve for MIC/LINE 1 is set accordingly. The equalization curve at the top of the display is replaced by the new curve you selected.

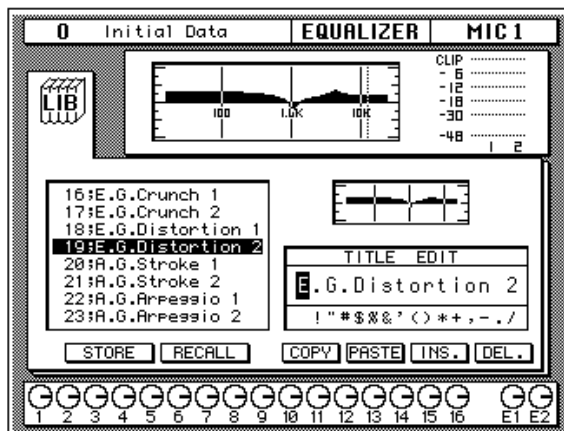

Your sound source is modified by the program you recalled. If the sound doesn't change, check if you have left the EQ ON switch turned OFF in the EQUALIZER display function. You can also quickly check if the LED inset in the EQ ON button of the SELECTED CHANNEL – EQUALIZER controls is illuminated or not.

6. Select the LIB icon with the CURSOR buttons and press the (ENTER) button.

The faster method of exiting from the EQUALIZER Library display function is by pressing the [EQ] button again.

The EQUALIZER display function reappears showing the new equalization curve for MIC/LINE 1. You can see the details of the new EQ settings.

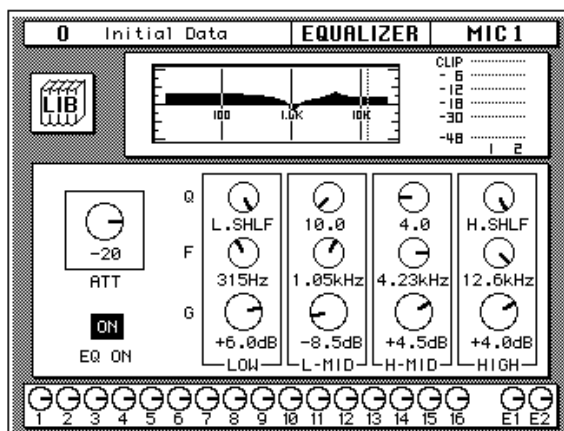

Undoing a Recall

If you decided you did not want to replace the current equalization curve with the program you selected from the EQ library, you can recall the previous curve.

1. Use the CURSOR buttons to select the RECALL icon and rotate the encoder wheel until program "U" is highlighted.

Program "U" is the UNDO buffer. It always contains the last curve that was applied to a channel.

2. Use the CURSOR buttons to select the RECALL icon and press (ENTER).

The original equalization curve is recalled.

Note: *The curve you first recalled and then used UNDO to replace is now itself in the UNDO buffer.*

Storing an EQ Program

Before you store an equalization curve, you need to create it using the EQUALIZER display function. Set the EQ parameters as detailed in the steps starting from "Setting the Gain" on page 25 of the *Getting Started Guide*.

1. Select the LIB icon with the CURSOR buttons and press the (ENTER) button.

It is still faster to select the EQUALIZER Library display function by pressing the [EQ] button again.

The EQUALIZER Library display function appears on the screen with your new equalization curve at the top of the display.

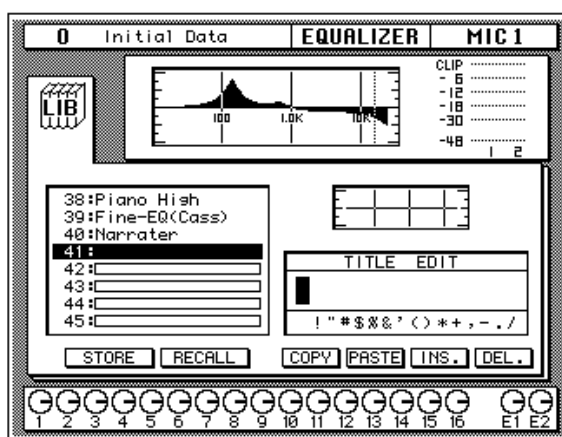

2. Select the STORE icon with the CURSOR buttons.

In order to scroll through the list of EQ programs, the cursor must be on the STORE, RECALL, COPY, or PASTE icons.

3. Use the encoder wheel to select an EQ program.

If you select one of the preset programs (1 to 32), an error message will flash on the screen when you attempt to store your program. Select a program from the 96 user programs (33 to 128).

You cannot store your settings to program "U" (the UNDO buffer) either.

4. Use the CURSOR buttons to select the TITLE EDIT box.

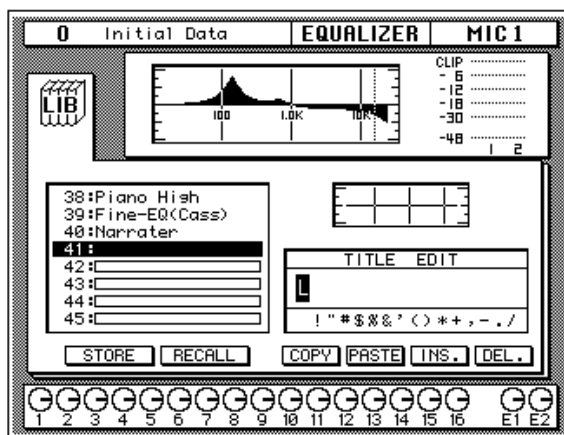

5. Select the individual character positions with the CURSOR buttons and rotate the encoder wheel to select the characters.

You can create a name of up to 16 characters long. It can contain any of the following characters:

	!	"	#	\$	%	&	'	()	*	+	,	-	.	/
0	1	2	3	4	5	6	7	8	9	:	;	<	=	>	?
@	A	B	C	D	E	F	G	H	I	J	K	L	M	N	O
P	Q	R	S	T	U	V	W	X	Y	Z	[\]	^	_
`	a	b	c	d	e	f	g	h	i	j	k	l	m	n	o
p	q	r	s	t	u	v	w	x	y	z	{		}	~	

Move the cursor to the first character position with the CURSOR buttons. Rotate the encoder to select the desired character. Move the cursor to the second character position and repeat.

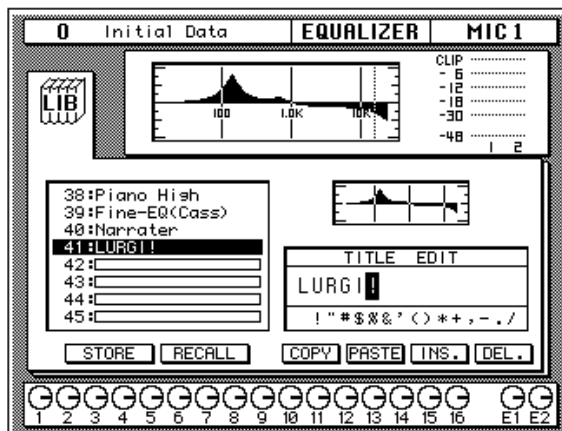

You can select the “INS.” control icon to insert a space (blank) at the current cursor location in the TITLE EDIT box. Select the icon with the CURSOR buttons and press the [ENTER] button. The “DEL.” control icon is used to delete the character under the current cursor location in the TITLE EDIT box.

Note: The “COPY” and “PASTE” control icons allow you to select the title from another EQ program and paste it into your program. These icons only copy the title. See “Control Icons” on page 54 of the User’s Guide.

6. Use the CURSOR buttons to select the STORE icon and press the (ENTER) button.

The 02R will display a popup confirmation request message asking if you want to store your settings in the selected EQ program. The popup has two control icons: “CANCEL” and “EXECUTE”.

Note: You can customize your 02R to prevent the confirmation popup from appearing during STORE operations. In this case, the program is stored without confirmation. See “Preferences” on page 162 of the User’s Guide for more information.

CANCEL is the default. To cancel the STORE operation, either press the [ENTER] button or wait about 10 seconds – the STORE operation will be automatically cancelled.

To store your settings, use the CURSOR buttons to select the “EXECUTE” control icon and press the [ENTER] button. The EQ program is stored.

Note: If you decide you don’t like an EQ program after you have stored it, it is very easy to overwrite it by creating new settings and storing them to the same location. Conversely, it is also very easy to accidentally overwrite a valued EQ program.

YOU SHOULD ALWAYS BE CAREFUL WHEN THE 02R DISPLAYS ITS CONFIRMATION POPUP MESSAGE!

Routing

This tutorial assumes you have a multitrack recorder and you have connected it to your Digital Recording Console 02R – after having one or more of the optional input/output cards installed:

- Alesis ADAT (CD8-AT) – This single slot card supports an 8-channel ADAT compatible modular digital multitrack recorder. It provides eight input channels and eight output channels. You can insert as many as four of these cards in the 02R.
- TASCAM TDIF-1 (CD8-TDII) – This single slot card supports an 8-channel TASCAM modular digital multitrack recorder. It provides eight input channels and eight output channels. You can insert as many as four of these cards in the 02R.
- YAMAHA (CD8-Y) – This single slot card supports an 8-channel YAMAHA modular digital multitrack recorder. It provides eight input channels and eight output channels. You can insert as many as four of these cards in the 02R.
- AES/EBU (CD8-AE double slot card, CD8-AE-S single slot card) – These cards support an 8-channel AES/EBU compatible modular digital multitrack recorder (such as the Akai DD1500 series). They provide eight input channels and eight output channels.
- Analog AD/DA (CD8-AD) – This double slot card supports any 8-channel analog multitrack recorder. It provides eight input channels and eight output channels. You can only insert two of these cards in the 02R.

The 02R allows you to route the first 16 MIC/LINE channels directly to an output. If you have the correct configuration, this means you can send direct outputs to a 16-track recorder (for example, two paired ADAT compatible modular digital multitrack recorders).

You can route any channel to one of the eight output buses. The buses feed to each of the four 8-track I/O slots in the back of the 02R. You can also route any channel to the stereo bus.

When you recall Scene Memory 0 “0 Initial Data”, all the channels are routed to the stereo bus.

Using the ROUTING Display Function

Similar to the equalization function, there are two ways of adjusting the routing for MIC/LINE 1.

One method is to use the ROUTING display function.

The more convenient method is to use the buttons of the ROUTING block of the SELECTED CHANNEL controls.

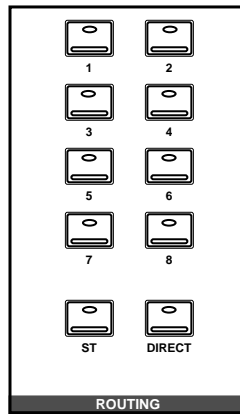

Note: You can customize the 02R so that when you press a button in the ROUTING block of the SELECTED CHANNEL controls, the ROUTING display function automatically appears on the screen. See "Preferences" on page 162 of the User's Guide for more information.

Selecting the Routing



1. Press the (ROUTING) button.

The ROUTING display function appears showing the selected routes for MIC/LINE 1.

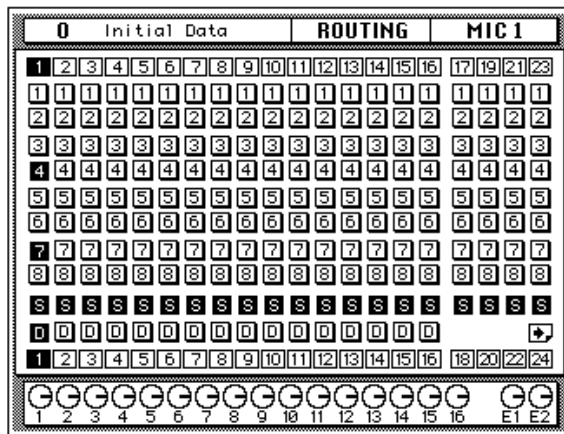

2. Use the ROUTING buttons of the SELECTED CHANNEL controls to select the routes for MIC/LINE 1.

As you press the ROUTING buttons, the LED inset in the button illuminates and the corresponding icon on the ROUTING display function screen changes to reverse video.

You can also select the routes by using the CURSOR buttons to move to the desired route icon and pressing the [ENTER] button.

Note: When you select a route, the signal from the channel will be routed to the selected bus. The output from that bus will appear at the corresponding outputs of all the I/O cards installed in the O2R. The only exception is when you are using I/O cards in slots 1 and 2 for direct output. See "Routing" on page 39 of the User's Guide for further details.

Panning

Similar to the equalization and routing functions, there are two ways of adjusting the pan for MIC/LINE 1.

One method is to use the PAN display function.

The more convenient method is to use the buttons and controls of the PAN block of the SELECTED CHANNEL controls.

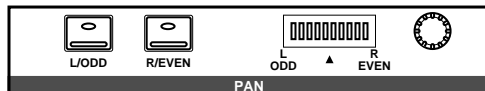

Note: You can customize your 02R so that when you adjust a control of the PAN block of the SELECTED CHANNEL controls, the PAN display function automatically appears on the screen. See "Preferences" on page 162 of the User's Guide for more information.

With a recording mixer like the Digital Recording Console 02R, you can send more effort building your monitor mix than would be worthwhile on a conventional analog mixer. Rather than labouriously having to reset all those parameters again for your mixdown, with the 02R you simply save the settings in a scene memory for instant recall.

Pan settings are also important when you are recording a signal to a pair of buses and want to create a balance between the buses – for example, when you close-mic a drum kit.

Adjusting the Pan



1. Press the (PAN) button.

The PAN display function appears.

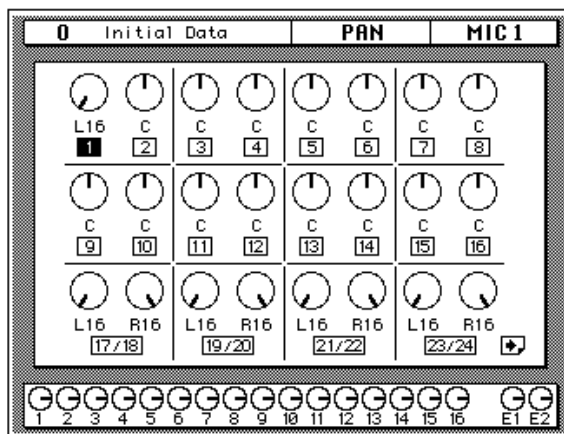

2. Press the (SEL) button for MIC/LINE 1 and rotate the pan rotary encoder.

The LED inset in the [L/ODD] button will be illuminated. The current pan position is indicated on the adjacent LED bargraph. As an alternative, you can use the CURSOR buttons to select the PAN icon for MIC/LINE 1 and rotate the encoder wheel until the desired value is shown.

You can adjust the pan position from extreme right/even (R16) through the centre (C) to extreme left/odd (L16). There are 33 pan positions to choose from.

Pairing Channels

You can pair the pan controls of two adjacent channels. Linking channels together is called GANG mode, and provides simultaneous pan adjustment

1. Press the (SEL) button for MIC/LINE 1.

You can also select the MIC/LINE 1 icon using the CURSOR buttons.

2. Press the (ENTER) button to connect the channels together.

You can also connect the channels together by simultaneously pressing the [L/ODD] and [R/EVEN] buttons of the PAN block of the SELECTED CHANNEL group.

The GANG is indicated by a pair of dotted lines linking the top and bottom of the pan control icons as shown in the following illustration:

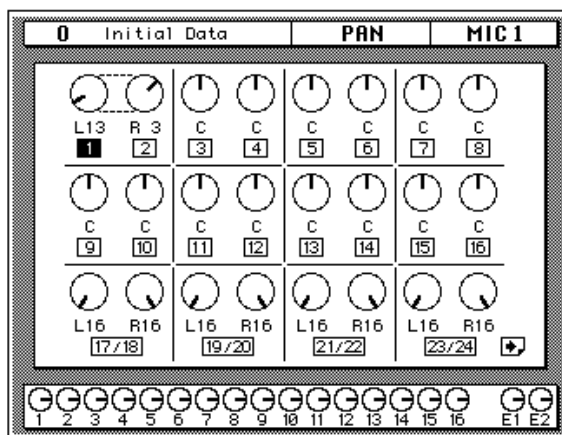

When you adjust one channel, the linked channel will also move by a corresponding amount. For further details, see "Stereo-Pair Pans" on page 37 of the *User's Guide*.

4

Secondary Recording Tutorial

In this chapter...

Auxiliary Send Channels	42
Setting the Auxiliary Send Level	43
Creating a Monitor Mix	45
Applying Effects	46
Recalling and Editing Effects	49
Patching in a Dynamics Processor	54
Using the Dynamics Library	57
Scene Memories	62

Auxiliary Send Channels

The Digital Recording Console 02R has eight auxiliary send channels.

AUX7 and AUX8 are used to feed the internal effects processors, with the signal remaining entirely in the digital domain.

The other auxiliary sends – AUX1 through AUX6 – can be used to feed external signal processors and effects units, foldback amplifiers, or multitrack recording equipment. AUX5 and AUX6 can also be used to construct a monitor mix and routed directly to either the studio or control room monitors. When a send is used to feed an external effects processor, the processed signal can be returned via one of the stereo input channels or an unused input channel.

There are two different ways to access the auxiliary send channels:

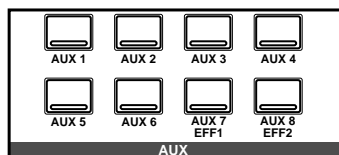

DISPLAY ACCESS – AUX buttons

These buttons access the Display Functions that set the auxiliary send levels for the recording console.

- The [AUX 1] to [AUX 6] buttons set the auxiliary send levels to the corresponding auxiliary bus. You can also select whether to send the signal pre or post fader.
- The [AUX 7] and [AUX 8] buttons also set the send levels to the corresponding auxiliary bus and can be sent pre or post fader. These two sends are routed to the internal effects unit. Therefore, the buttons also allow you to select and set the effects parameters.

When you press any one of these buttons, the faders switch from controlling the input levels to controlling the auxiliary send levels.

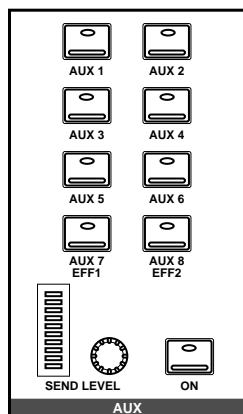

SELECTED CHANNEL – AUX controls

These buttons and controls set the auxiliary send levels for the currently selected channel.

- The [AUX 1] to [AUX 8] buttons allow you to select the auxiliary buses you want to send the selected channel signal to.
- The SEND LEVEL rotary encoder is used to set the level – indicated by the adjacent LED bargraph.
- The [ON] button is used to turn the send on or off.

Setting the Auxiliary Send Level

The following example shows setting the send level for MIC/LINE 1 to the first auxiliary channel, AUX1.



1. Press the (AUX 1) button.

The AUX1 display function appears:

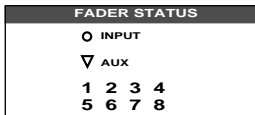
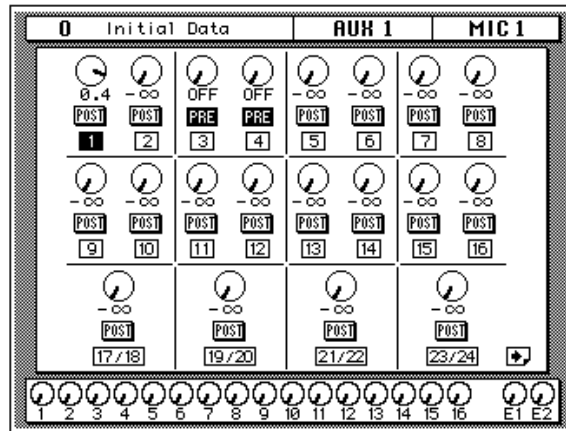

The faders change from channel level controls to auxiliary send level controls. To indicate the change, the AUX LED of the FADER STATUS indicator will illuminate. The number indicator corresponding to the current AUX button (in this case, AUX1) is also illuminated. The faders will automatically relocate from their channel level positions to the auxiliary send level positions.

Note: Avoid blocking the fader movements when the faders relocate to their auxiliary send positions by placing objects on the 02R. It is possible to damage the faders.

Although the faders have moved to the auxiliary send level positions, the 02R remembers the channel signal levels. You will still be able to hear the signal.

2. Select MIC/LINE 1 using the (SEL) buttons or the CURSOR buttons.

Turn the auxiliary send on by pressing the [AUX 1] button and then the [ON] button in the AUX group of the SELECTED CHANNEL controls. The default is for the send to be ON, therefore this step is not usually required.

Note: In order to change the auxiliary send status from on to off, you must first select the send channel with the corresponding button of the SELECTED CHANNEL – AUX controls

3. To change the auxiliary send from post to pre fader, press the (ENTER) button.

The PRE icon becomes the POST icon and is highlighted in reverse video when the signal is pre-fader.

4. To change the signal level, adjust the fader for MIC/LINE 1 until the desired value is obtained.

You can use the rotary encoders for the tape returns or press the [FLIP] button. Then the tape return channels can be operated by the faders. The effect returns can only be adjusted with the rotary encoders.

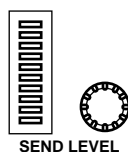

You can also use the SEND LEVEL encoder in the AUX group of the SELECTED CHANNEL controls. You must press the corresponding [AUX 1] button to make certain you are adjusting the signal level for the correct auxiliary channel.

Note: *In order to adjust the auxiliary send level with the SEND LEVEL encoder, you must first select the send channel with the corresponding button of the SELECTED CHANNEL – AUX controls*

Creating a Monitor Mix

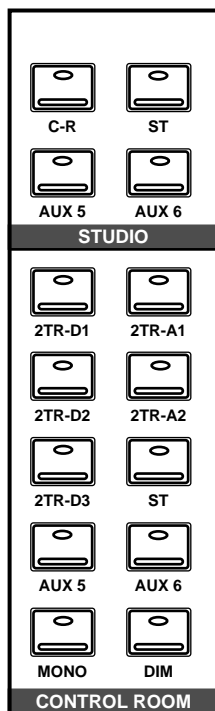

The Digital Recording Console 02R has two different monitoring outputs – the control room outputs and the studio outputs – plus, of course, the PHONES output (which are a duplicate of the control room output).

During a multitrack recording session, what you want to listen to in the control room is often very different from what the musicians need in the studio. For example, while recording a rhythm section, the bass player and the drummer may want to hear the kick drum at a much higher volume than you need in the control room.

To cater to this requirement, the 02R allows you to create a monaural monitor mix using either AUX5 or AUX6 or a stereo mix using both AUX5 and AUX6.

Monitor Mix Process

The process for creating the monitor mix is similar to the steps as detailed starting from “Setting the Auxiliary Send Level” on page 43 of the *Getting Started Guide*

1. **Press the (AUX 5) button.**
2. **Select MIC/LINE 1 using the (SEL) buttons or the CURSOR buttons.**

Turn the auxiliary send on by pressing the [AUX 5] button and then the [ON] button in the AUX group of the SELECTED CHANNEL controls.

You should leave the send pre-fader. This will allow the musicians to continue to hear each other independently of anything you may be doing in the control room.

3. **Press the (AUX 5) button of the STUDIO buttons group.**

You should also press the [AUX 5] button of the CONTROL ROOM buttons group so you can hear the results of adjusting the levels.

4. **Adjust the fader for MIC/LINE 1 until the desired signal level is obtained.**

Use the Talkback system to check with your musicians, to see if they are content with the signal levels you have set. When you finish setting the studio monitor levels, press the [ST] button of the CONTROL ROOM buttons group for monitoring in the control room.

Applying Effects

The Digital Recording Console 02R features two internal multi-effects stereo processors: Effect1 and Effect2. These are fed by AUX7 and AUX8, and the processed signals are returned via EFF1 RTN and EFF2 RTN, respectively. When you use the internal effects, the signal gets processed without ever leaving the digital domain.

Effects can be applied to input channels or the tape return channels. Effects are organized into programs. There are 40 preset effects programs (1 through 40) and 88 user effects programs (41 through 128 plus an UNDO buffer) for you to store your own settings.

Setting the Send Levels

The process for applying effects is similar to the steps as detailed in “Setting the Auxiliary Send Level” on page 43 of the *Getting Started Guide*. The following example shows applying effects to MIC/LINE 1 using the auxiliary channel, AUX7.



1. Press the (AUX 7) button.

The AUX7 display function appears:

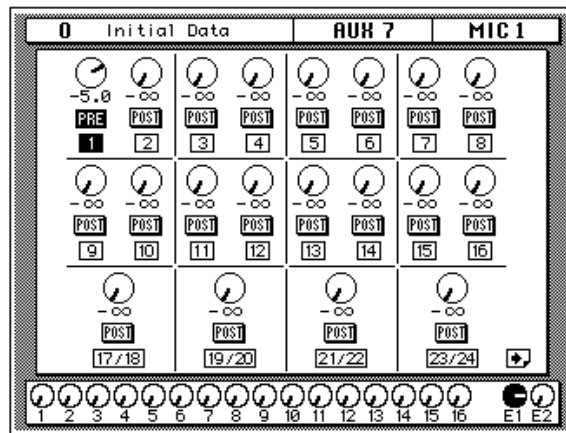

Note: If one of the effects edit screens appears, press the [AUX 7] button again until the channel levels screen appears.

The faders will automatically relocate from the channel level positions to the auxiliary send level positions. Even though the fader has changed positions, the 02R remembers the channel signal levels and you can still hear the sound.

Note: Avoid blocking the fader movements when the faders relocate to their auxiliary send positions by placing objects on the 02R. It is possible to damage the faders.

2. Select MIC/LINE 1 using the (SEL) buttons or the CURSOR buttons.

Turn the auxiliary send on by pressing the [AUX 7] button and then the [ON] button in the AUX group of the SELECTED CHANNEL controls.

3. Press the (ENTER) button to change the auxiliary send from pre to post fader.

Sends to the effects are usually post fader. This means the the signal level feed into the effects processor to follow the “dry” channel level.

4. Adjust the fader for MIC/LINE 1 until the desired signal level is obtained.

Adjusting the Effect Return

The effect return channel is similar to one of the input channels except that it has no analog component, and therefore no gain or input pad need to be applied. Otherwise the steps are similar to those starting with “Setting the GAIN” on page 21 of the *Getting Started Guide*.

The easiest way of applying all the required adjustments is to select the View display function. This allows you to see all the parameters of the channel on one screen, while you can still use the dedicated buttons and controls of the SELECTED CHANNEL group.



1. Press the (VIEW) button and press the (SEL) button for EFF 1 RTN.

The VIEW display function for the effect return channel EFF 1 RTN appears:

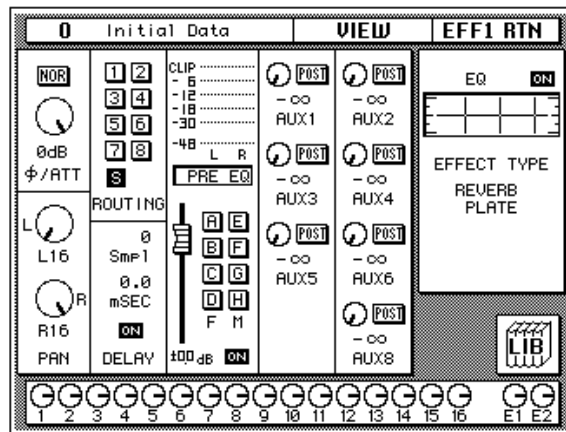

2. If the sound is distorted or the level is constantly going up to CLIP, use the CURSOR buttons to select the ∅/ATT icon. Adjust the level with the encoder wheel.

As the effect return signal is entirely digital, if CLIP is reached, you will experience digital clipping distortion.

Note: *In many cases, clipping in the effect return channel is caused by the send level being too high. You may need to adjust the send levels as well as the attenuation if you experience clipping.*

3. Select the PAN icon with the CURSOR buttons and set the pan position using the encoder wheel.

Note: *Setting the pan position, routing and equalization can all be done quickly and easily with the dedicated controls of the SELECTED CHANNEL block.*

4. Use the CURSOR buttons to select the ROUTING icons. Press the (ENTER) button to select routes for the effect return signal.

By default (assuming you are still working with Scene Memory 0 “0 Initial Data”) the effect return channel is routed to the stereo bus.

Note: *Although you cannot route the effect return channel to the direct outputs, you can route it to the same bus that the input channel is routed to, allowing you to record the effect together with the input signal.*

Many engineers prefer to add effects only during the final mix. It is very easy to apply effects, but difficult to remove it once it has been recorded. You may want to send the effect to the monitor mix, however, especially when recording a vocalist – many vocalists dislike hearing their voice “dry” in the monitors.

5. Select the EQ graph with the CURSOR buttons and press the (ENTER) button.

The 02R will automatically switch to the EQUALIZER display function. Follow the steps detailed in “Applying EQ” on page 24 of the *Getting Started Guide* to set the equalization for the effect return channel EFF 1 RTN.

Note: *Many engineers prefer to hold off applying EQ to a recording until they are ready to mixdown. Again, it is much easier to apply EQ than to subsequently remove it.*

Recalling and Editing Effects

Once you have applied effects to MIC/LINE 1, you need to know how to recall effects programs from the effects library and to adjust their parameters in order to create your own effect programs.

Recalling Effects Programs



1. Press the (AUX 7) button until the Effect Edit screen appears:

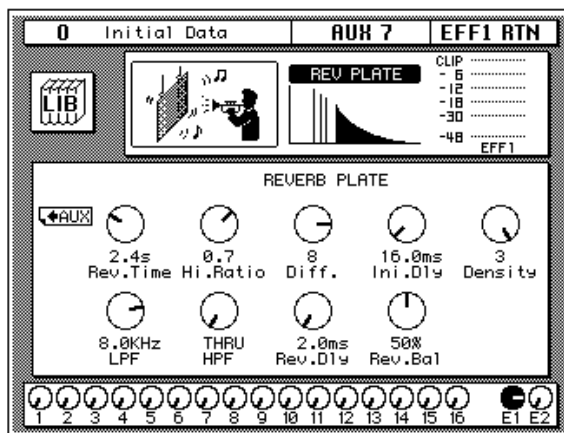

The parameters of the currently selected effects program are displayed on this screen. You will see the library (LIB) icon, an effects curve or icon (depending on the selected effect), and a level meter for the effects return stereo pair, as well as control icons for adjusting the parameters.

2. Use the CURSOR buttons to select the LIB icon and press the (ENTER) button.

The Effect Library screen appears:

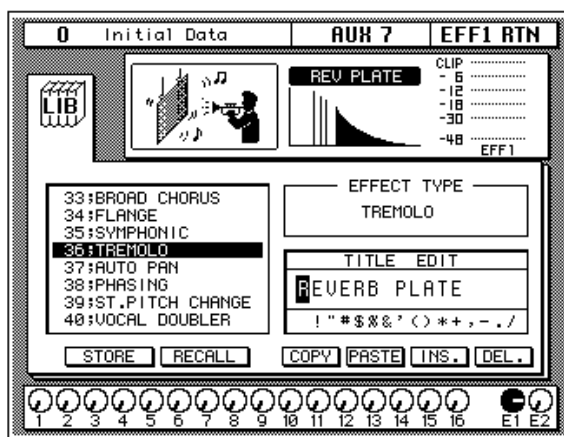

(You can also press the [AUX 7] button again to get to this screen.)

3. Use the CURSOR buttons to select the RECALL icon. Rotate the encoder wheel to select an effects program.

The 02R will scroll through the available effects programs. The program that is highlighted is the program that will be recalled when you press the [ENTER] button.

4. Press the (ENTER) button.

The effects program is recalled.

If you attempt to recall a user program that is empty, the 02R will flash an error message, indicating that the selected memory location is not available for recall.

Editing Effects

You can edit the preset effects programs and then store them as user effects programs. The 02R has 40 preset programs (1 through 40). Some are simple variations of a basic effect, for example, different types of reverb and delay (echo) are available.

Select the preset effects program that is closest to the effect you are trying to achieve and edit its parameters.

1. Use the CURSOR buttons to select the LIB icon and press the (ENTER) button.

The 02R will return to the Effect Edit screen:

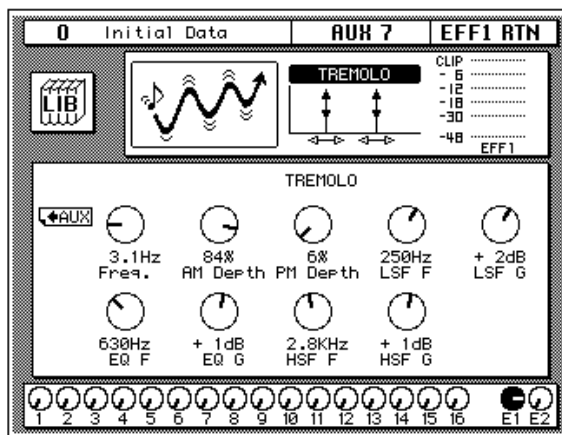

You can also press the [AUX 7] button to get to this screen. This button allows you to access the auxiliary send levels, the effects editing, and the effects library screens. You may need to press it several times before the 02R will return to the Effect Edit screen.

2. Select the various parameter icons with the CURSOR buttons. Adjust the value with the encoder wheel.

As you adjust the parameters, you should listen carefully to the results. Some of the parameters of some of the effects are very subtle in their effect, others are quite obvious.

After you have modified the effects program to your satisfaction, you are ready to store it:

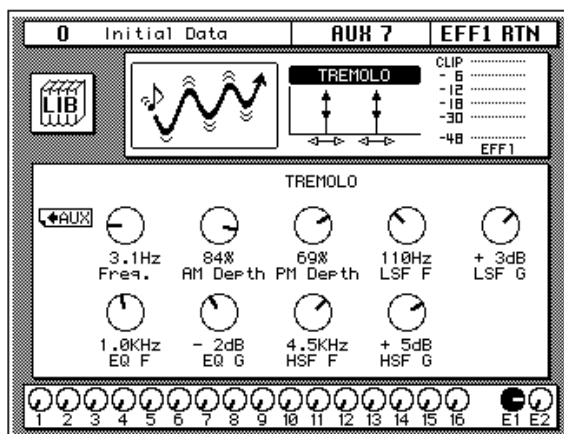

Storing a User Effect

The Digital Recording Console 02R has 88 user effects program locations (41 through 128) for you to store your own settings. You can store your effects program in the Effect Library, or you can just rely on the 02R scene memory to recall your settings. The following instructions show you how to store your program in the library.

1. Select the LIB icon with the CURSOR buttons and press the (ENTER) button.

The Effect Library screen appears:

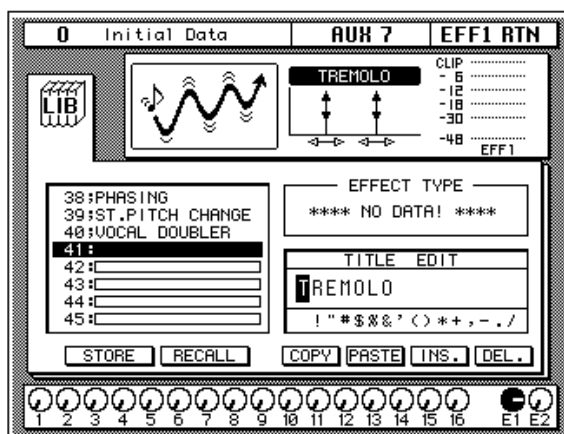

2. Use the CURSOR buttons to select the TITLE EDIT box:

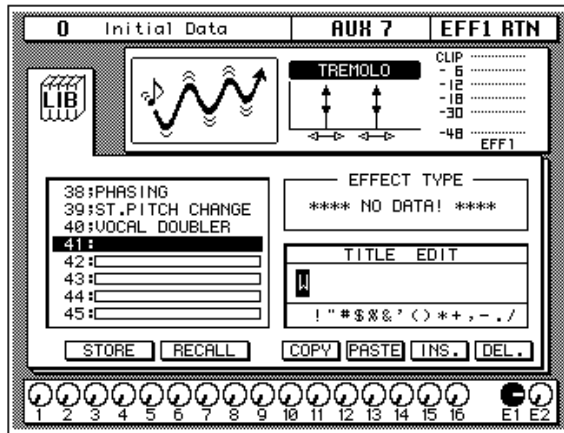

3. Select the individual character positions with the CURSOR buttons. Use the encoder wheel to select the characters.

You can create a name of up to 16 characters long. It can contain any of the following characters:

	!	“	#	\$	%	&	'	()	*	+	,	-	.	/
0	1	2	3	4	5	6	7	8	9	:	;	<	=	>	?
@	A	B	C	D	E	F	G	H	I	J	K	L	M	N	O
P	Q	R	S	T	U	V	W	X	Y	Z	[\]	^	_
`	a	b	c	d	e	f	g	h	i	j	k	l	m	n	o
p	q	r	s	t	u	v	w	x	y	z	{		}	~	

Move the cursor to the first character position with the CURSOR buttons. Rotate the encoder to select the desired character. Move the cursor to the second character position and repeat:

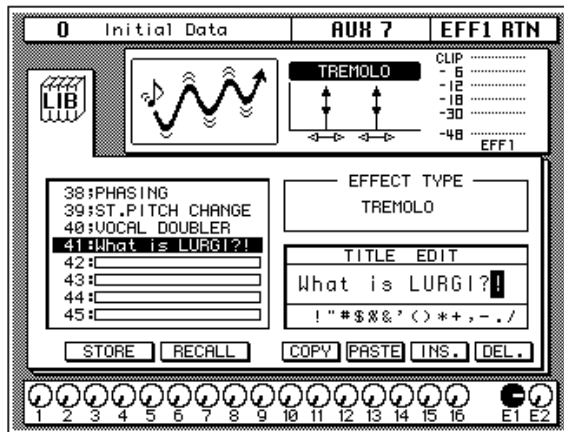

You can select the “INS.” control icon to insert a space (blank) at the current cursor location in the TITLE EDIT box. Select the icon with the CURSOR buttons and press the [ENTER] button. The “DEL.” control icon is used to delete the character under the current cursor location in the TITLE EDIT box.

Note: The “COPY” and “PASTE” control icons allow you to select the title from another effects program and paste it into your program for subsequent editing. These icons only copy the title. See “Control Icons” on page 96 of the User’s Guide.

4. Use the CURSOR buttons to select the STORE icon. Rotate the encoder wheel to select an effects program.

If you select one of the preset programs (1 to 40), an error message, “Preset is read only!”, will flash on the screen when you attempt to store your program. Select a program from the 88 user programs (41 to 128).

You cannot store your settings to program “U” (the UNDO buffer) either.

5. Press the (ENTER) button.

The 02R will display a popup confirmation request message asking if you want to store your settings in the selected effects program. The popup has two control icons: “CANCEL” and “EXECUTE”.

Note: You can customize your 02R to prevent the confirmation popup from appearing during STORE operations. See “Preferences” on page 162 of the User’s Guide for more information.

CANCEL is the default. To cancel the STORE operation, either press the [ENTER] button or wait about 10 seconds – the STORE operation will be automatically cancelled.

To store your settings, use the CURSOR buttons to select the “EXECUTE” control icon and press the [ENTER] button. The effects program is stored.

Note: If you decide you do not like an effects program after you have stored it, it is very easy to overwrite it by creating new settings and storing them to the same location. Conversely, it is also very easy to accidentally overwrite a valued effects program.

YOU SHOULD ALWAYS BE CAREFUL WHEN THE 02R DISPLAYS ITS CONFIRMATION POPUP MESSAGE!

Patching in a Dynamics Processor

The Digital Recording Console 02R features comprehensive dynamics processors for all the channel inputs, tape returns, and stereo and bus outputs. These processors allow you to compress, expand, compress/expand (compand), gate, or duck the signals passing through the mixer.

The dynamics processors are generally used to correct or control signal levels, giving you unparalleled sonic quality and flexibility. You can also use them creatively to shape the volume envelope of a sound.

Compressor

A compressor provides a form of automatic level control. It attenuates high levels, thus effectively reducing the dynamic range, making it much easier to control signals and set appropriate fader levels. Reducing the dynamic range also means that recording levels can be set higher, therefore improving the signal-to-noise performance.

Limiting is an extreme form of compression, where the output signal is sharply attenuated so that it cannot exceed a particular level.

Expander

An expander is another form of automatic level control. By attenuating the signal below the threshold, the expander reduces low-level noise or expands the dynamic range of the recorded material.

Compander

A compander is a compressor/expander – a combination of signal compression and expansion. The compander attenuates the input signal above the threshold as well as the level below the width. For very dynamic material, this program allows you to retain the dynamic range without having to be concerned with excessive output signal levels and clipping.

Gate and Ducking

A gate, or noise gate is an audio switch used to mute signals below a set threshold level. It can be used to suppress background noise and hiss from valve (tube) amps, effects pedals, and microphones.

Ducking is used to automatically reduce signal levels when the level of a source signal exceeds a specified threshold. It is used for voice-over applications where, for example, level of background music is automatically reduced, allowing an announcer to be heard clearly.

Compressing the Stereo Output

You can apply dynamics to the input channels, for example, the channel you have used throughout these tutorials – MIC/LINE 1. The selection of dynamics program would depend on the input material: a gate for a noisy guitar amp, a compressor for an unpredictable vocalist, and so on.

In this case, apply a compressor to the stereo bus to add punch to the output signal. You can hear the effect by monitoring the stereo bus with the control room buttons.



1. Press the (DYNAMICS) button.

The DYNAMICS display function appears:

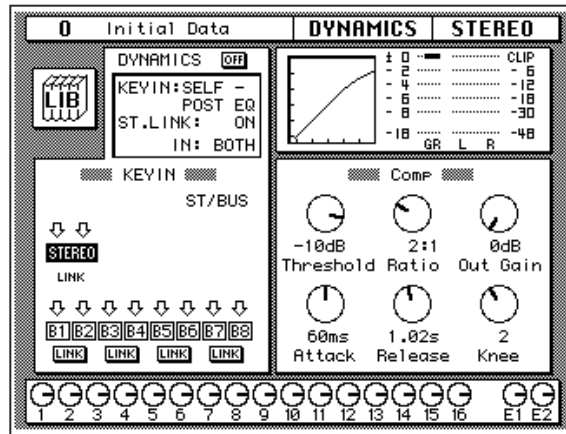

2. Press the (SEL) button for STEREO.

Note: If one of the icons B1 through B8 in the KEY IN section of the display is highlighted in reverse video, it means the corresponding output bus is selected. To select the stereo bus, move the cursor to the STEREO icon using the CURSOR buttons and press the [ENTER] button.

By default (assuming you are still working with Scene Memory 0 “0 Initial Data”) the dynamics processor is set to a compression program with all parameters set to the default value as shown in the table below:

Threshold	0 dB	Knee	hard
Ratio	1:1	Attack	0 ms
Out Gain	0 dB	Release	5 ms *1

*1 This value is obtained when the sampling frequency is 48 kHz.

The processor is OFF.

3. Use the CURSOR buttons to select the DYNAMICS OFF icon and press the (ENTER) button to turn the processor on.

The icon is highlighted in reverse video with the text changed to ON. Being able to easily turn the dynamics processor on and off allows you to perform quick A-B listening tests.

4. Select the KEY IN prompt with the CURSOR buttons. Rotate the encoder wheel or press the (ENTER) button to select the trigger source for the processor.

By default, the STEREO channel is triggered by itself, pre-equalization (SELF – PRE-EQ). You can select post-equalization or the signal on the auxiliary buses, AUX1 or AUX2.

Note: *As you change the KEY IN parameter, the icons in the KEY IN block on the display also change.*

You should select either SELF – PRE-EQ or SELF – POST-EQ.

5. Use the CURSOR buttons to select the compressor control icons.

The control icons are in the box entitled “Comp”. The title of this box changes depending on the program you select from the dynamics library.

6. Adjust the value of each control icon by rotating the encoder wheel.

To compress the stereo output signal, try settings similar to the table below:

Threshold	–10 dB	Knee	2
Ratio	2:1	Attack	60 ms
Out Gain	0 dB	Release	1.02 sec *1

*1 This value is obtained when the sampling frequency is 44.1 kHz or 48 kHz.

The above settings provide a 2:1 compression above –10 dB. This means for every 1 dB change in input signal level above –10 dB there will be a 0.5 dB change in the output level. You can increase the output level without as much risk of clipping. The overall effect is the output signal sounds louder, essentially because you have limited – or compressed – the dynamic range.

Experiment with the settings until you get an effect that you like.

Using the Dynamics Library

Once you have applied a dynamics processor to the stereo bus, you need to know how to recall dynamics programs from the library and to adjust the parameters to create your own dynamics programs.

Recalling Dynamics Programs



1. Press the (DYNAMICS) button again.

The DYNAMICS Library display screen appears:

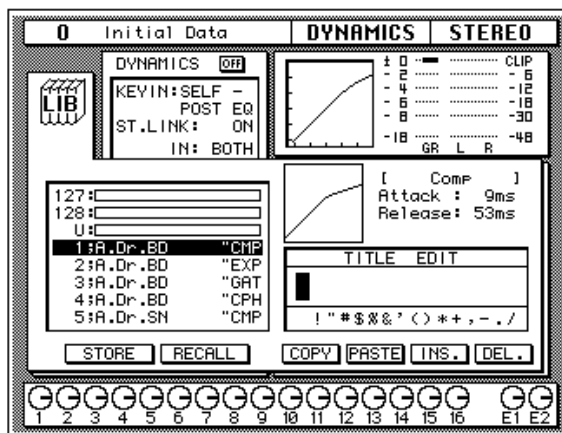

You can also select the LIB icon with the CURSOR buttons and press the [ENTER] button.

2. Use the CURSOR buttons to select the RECALL icon. Rotate the encoder wheel to select a dynamics program.

The 02R will scroll through the available dynamics programs. The program that is highlighted is the program that will be recalled when you press the [ENTER] button.

3. Press the (ENTER) button.

The dynamics program is recalled.

If you attempt to recall a user program that is empty, the 02R will flash an error message, indicating that the selected memory location is not available for recall.

Note: Unlike EQ and effects, it is sometimes essential to apply a dynamics processor to an input signal as you are recording multitrack sources. Some signals are too unpredictable or noisy to record without some form of compression or gating. However, you should be very selective about the dynamics you apply, as the same rule holds: it is easy to add the effect, but very difficult to remove it afterwards.

Editing Dynamics Programs

You can edit the preset dynamics programs and then store them as user programs. The Digital Recording Console 02R has 40 preset programs (1 through 40). Each program is a variation on the six basic dynamics processors available:

- Compressor (CMP)
- Gate (GAT)
- Expander (EXP)
- Compander – Hard (CPH)
- Compander – Soft (CPS)
- Ducking (DUK)

Select the preset dynamics program that is closest to the effect you are trying to achieve and edit its parameters. For a list of the preset programs, see “Preset Dynamics Programs” on page 62 of the *User’s Guide*.

Note: *The program name of each preset dynamics program contains a three letter code indicating the type of dynamics processor it is.*

1. Press the (DYNAMICS) button.

The 02R will return to the DYNAMICS display function:

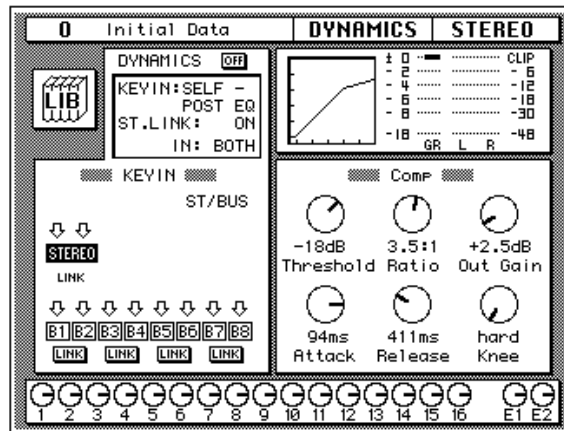

You can also select the LIB icon with the CURSOR buttons and press the [ENTER] button.

2. Select the various parameter icons with the CURSOR buttons. Adjust the value with the encoder wheel.

After you have modified the effects program to your satisfaction, you are ready to store it.

Storing a User Dynamics Program

The Digital Recording Console 02R has 88 user dynamics program locations (41 through 128) for you to store your own settings. You can store your dynamics program in the Dynamics Library, or you can just rely on the 02R scene memory to recall your settings. The following instructions show you how to store your program in the library.

1. Press the (DYNAMICS) button again.

The DYNAMICS Library display screen appears:

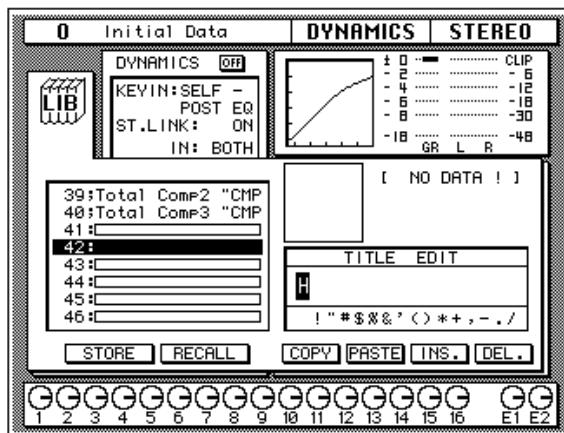

You can also select the LIB icon with the CURSOR buttons and press the [ENTER] button.

- 2. Use the CURSOR buttons to select the TITLE EDIT box.**
- 3. Select the individual character positions with the CURSOR buttons. Use the encoder wheel to select the characters.**

You can create a name of up to 16 characters long. It can contain any of the following characters:

	!	"	#	\$	%	&	'	()	*	+	,	-	.	/
0	1	2	3	4	5	6	7	8	9	:	;	<	=	>	?
@	A	B	C	D	E	F	G	H	I	J	K	L	M	N	O
P	Q	R	S	T	U	V	W	X	Y	Z	[\]	^	_
`	a	b	c	d	e	f	g	h	i	j	k	l	m	n	o
p	q	r	s	t	u	v	w	x	y	z	{		}	~	

Move the cursor to the first character position with the CURSOR buttons. Rotate the encoder to select the desired character. Move the cursor to the second character position and repeat:

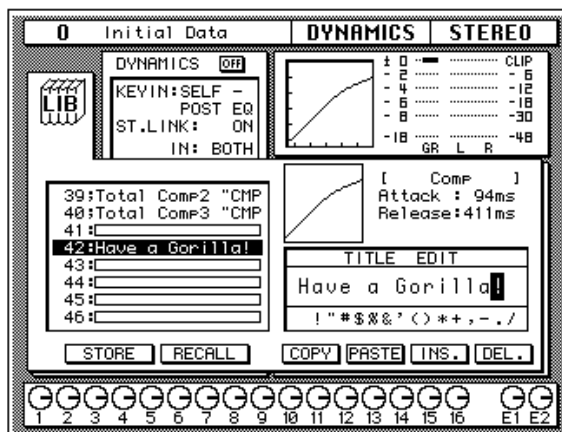

You can select the “INS.” control icon to insert a space (blank) at the current cursor location in the TITLE EDIT box. Select the icon with the CURSOR buttons and press the [ENTER] button. The “DEL.” control icon is used to delete the character under the current cursor location in the TITLE EDIT box.

Note: The “COPY” and “PASTE” control icons allow you to select the title from another dynamics program and paste it into your program for subsequent editing. These icons only copy the title. See “Control Icons” on page 74 of the User’s Guide.

4. Use the CURSOR buttons to select the STORE icon. Rotate the encoder wheel to select a dynamics program.

If you select one of the preset programs (1 to 40), an error message, “Preset is read only!”, will flash on the screen when you attempt to store your program. Select a program from the 88 user programs (41 to 128). You cannot store your settings to program “U” (the UNDO buffer) either.

5. Press the (ENTER) button.

The 02R will display a popup confirmation request message asking if you want to store your settings in the selected dynamics program. The popup has two control icons: “CANCEL” and “EXECUTE”.

Note: You can customize your 02R to prevent the confirmation popup from appearing during STORE operations. See “Preferences” on page 162 of the User’s Guide for more information.

CANCEL is the default. To cancel the STORE operation, either press the [ENTER] button or wait about 10 seconds – the STORE operation will be automatically cancelled.

To store your settings, use the CURSOR buttons to select the “EXECUTE” control icon and press the [ENTER] button. The dynamics program is stored.

Note: *If you decide you do not like a dynamics program after you have stored it, it is very easy to overwrite it by creating new settings and storing them to the same location. Conversely, it is also very easy to accidentally overwrite a valued dynamics program.*

YOU SHOULD ALWAYS BE CAREFUL WHEN THE 02R DISPLAYS ITS CONFIRMATION POPUP MESSAGE!

Scene Memories

The Digital Recording Console 02R scene memories are a snapshot of all the digital parameters of the mixer. The 02R has 64 mix scene memory locations. Each can be named for easy identification.

There are two special scene memories. “0 Initial Data” is a read-only scene memory that resets the 02R to its default settings. The other is an undo buffer entitled “U”. Recalling the undo buffer restores the last state of the 02R.

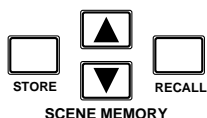

Scene memories can be stored and recalled using the [STORE] and [RECALL] buttons. Scene memories are selected using the SCENE MEMORY increment or decrement buttons.

They can also be recalled by the automation system or by using MIDI Program Changes from a computer, MIDI sequencer, or MIDI footswitch. You can save scene memories to a MIDI data file.

Storing a Scene Memory

When you store a scene memory, you should check that all the mixer settings in the Edit Buffer are correct. Some settings may have been adjusted accidentally, or by someone else. If you are not sure about the exact contents of the mixer and do not want to labouriously check each setting, recall the initial mixer settings (Scene Memory 0 “0 Initial Data”), make the adjustments that you really want, and then store.

Note: You may want to store the current mix settings to an unused scene memory, just in case.

1. Use the SCENE MEMORY increment or decrement buttons to select a scene memory.

You cannot store your settings to either of the special scene memories: “U” (the UNDO buffer) or “0 Initial Data”. If you select these scene memories, an error message will flash on the screen when you attempt to store your scene memory.



When you select a new scene memory, the number displayed in the SCENE MEMORY LED indicator flashes.

2. Press the (STORE) button.

The 02R will display a popup confirmation request message asking if you want to store your settings in the selected scene memory. The popup has two control icons: “CANCEL” and “EXECUTE”.

Note: You can customize your 02R to prevent the confirmation popup from appearing during STORE operations. See “Preferences” on page 162 of the User’s Guide for more information.

CANCEL is the default. To cancel the STORE operation, either press the [ENTER] button or wait about 10 seconds – the STORE operation will be automatically cancelled.

To store your settings, use the CURSOR buttons to select the “EXECUTE” control icon and press the [ENTER] button.

3. The scene memory is stored.

Note: *If you decide you do not like a scene memory after you have stored it, it is very easy to overwrite it by adjusting the mixer settings and storing them to the same location. Conversely, it is also very easy to accidentally overwrite a valued scene memory. The 02R has a “Memory Protect” feature to help prevent this, but this feature can interfere with your work, plus it is very easy to turn off the protection. See “Protecting Scene Memories” on page 118 of the User’s Guide*

YOU SHOULD ALWAYS BE CAREFUL WHEN THE 02R DISPLAYS ITS CONFIRMATION POPUP MESSAGE!

Naming a Scene Memory

- 1. Use the SCENE MEMORY increment or decrement buttons to select the correct scene memory.**

When you select a new scene memory, the number displayed in the SCENE MEMORY LED indicator flashes.



- 2. Press the (SCENE MEMORY) button.**

The SCENE display function appears:

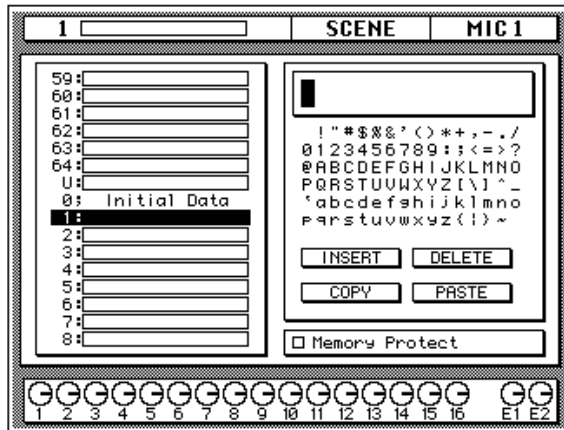

Note: *You may have to press the [SCENE MEMORY] button several times to get to the main screen as shown above.*

To ensure the scene memory you are attempting to edit is the correct one, you should recall it before proceeding with the next step. See “Recalling a Scene Memory” on page 65 of the *Getting Started Guide*.

3. Use the CURSOR buttons to select the title edit box.
4. Select the individual character positions with the CURSOR buttons. Use the encoder wheel to select the characters.

You can create a name of up to 16 characters long. It can contain any of the following characters:

	!	“	#	\$	%	&	'	()	*	+	,	-	.	/
0	1	2	3	4	5	6	7	8	9	:	;	<	=	>	?
@	A	B	C	D	E	F	G	H	I	J	K	L	M	N	O
P	Q	R	S	T	U	V	W	X	Y	Z	[\]	^	_
`	a	b	c	d	e	f	g	h	i	j	k	l	m	n	o
p	q	r	s	t	u	v	w	x	y	z	{		}	~	

Move the cursor to the first character position with the CURSOR buttons. Rotate the encoder to select the desired character. Move the cursor to the second character position and repeat:

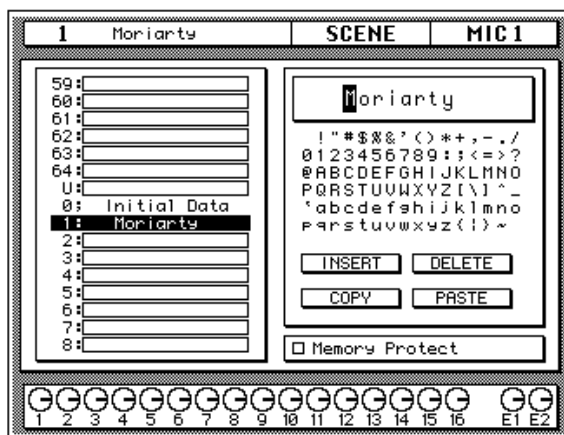

You can select the “INSERT” control icon to insert a space (blank) at the current cursor location in the title edit box. Select the icon with the CURSOR buttons and press the [ENTER] button. The “DELETE” control icon is used to delete the character under the current cursor location in the title edit box.

Note: The “COPY” and “PASTE” control icons allow you to select the title from another scene memory and paste it into the title edit box for subsequent editing.

5. Press the (STORE) button.

If you respond to the confirmation popup by selecting “EXECUTE” and pressing the [ENTER] button, the scene memory is stored with its new name.

Recalling a Scene Memory

Scene memories are recalled using the [RECALL] button. They can also be recalled by the automation system or by using MIDI Program Change Messages.

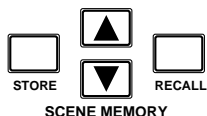

1. Use the SCENE MEMORY increment or decrement buttons to select the desired scene memory.

When you select a new scene memory, the number displayed in the SCENE MEMORY LED indicator flashes.

2. Press the (RECALL) button.

The selected scene memory is recalled.

Note: When recalling mix scenes, be aware that volume levels may change suddenly as channels are switched ON and faders moved. The 02R has a feature that allows you to fade the levels as a scene memory is loaded, but it cannot compensate for the sudden burst of a channel suddenly being switched on. See “Fade Time” on page 121 of the User’s Guide for further information.

When the scene memory is recalled, the number displayed in the SCENE MEMORY LED indicator stops flashing.

If you attempt to recall a scene memory that is empty, the 02R will flash an error message, indicating that the selected memory location is not available for recall.

5

Mixing and Automation

In this chapter...

What is 02R Automation?	68
Real-Time Automation	69
Editing Automation Events	76
Off-Line Automix Editing	81
Using the AUTOMIX Library	86

What is 02R Automation?

There are three basic steps to making a multitrack recording:

- Setup and initial tracks
- Overdubbing
- Mixdown

Each step is vital in order to produce a satisfactory recording, but the most difficult one for most engineers is the mixdown. The musicians have finished their work. They have played their instruments and sung their vocals. All that raw material is stored on your multitrack recorder, waiting to be turned into a perfect final mix.

To assist you with this difficult task, the Digital Recording Console 02R has a fully-featured on-board automation system. It memorizes fader position changes, switches individual channels on or off, adjusts the equalization or pan positions, and changes the auxiliary sends – all based on timecode. It can also recall scene memories and programs from the equalizer library, effects library, dynamics library, and channel library.

This allows you to record an entire mixing session, and then edit the individual channel settings in multiple passes until you have achieved perfection. You can punch-in to fine tune a specific parameter or you can use one of the event editors to adjust the timecode position of a channel setting or scene change. You can easily create a mix that would be virtually impossible to achieve on a standard analog mixer.

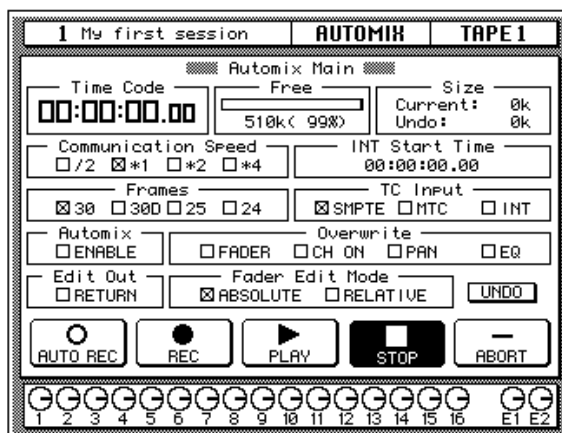

Automix Memory

The Digital Recording Console 02R has a current automix buffer and 16 automix memories. There is also an undo buffer. Only the current mix can be played back and recorded. You can store the current mix in any of the 16 automix memories.

Real-Time Automation

These tutorials have assumed you are using your Digital Recording Console 02R with one or more of the optional I/O cards installed and a multitrack recorder connected. In this section, you will be synchronizing your multitrack recorder to the 02R. There are three basic ways of doing this:

- If your multitrack recorder is equipped with a SMPTE timecode output connector, you use an audio cable to connect it to the SMPTE TIME CODE INPUT jack on the rear panel of the 02R.
- Use an external SMPTE timecode generator if your multitrack recorder cannot output SMPTE time. You need to record timecode onto one of the tracks of your multitrack recorder and connect the output from that track directly to the SMPTE TIME CODE INPUT jack on the rear panel of the 02R.
- Use a MIDI sequencer to send MTC (MIDI timecode) to the 02R as well as your multitrack recorder. Connect a MIDI cable to the MTC TIME CODE INPUT jack on the rear panel of the 02R.

There is an additional option – you can automate the 02R using its internal timecode generator. However, you cannot synchronize with an external device as the 02R has no timecode output connectors. This mode is effective for learning how to use the automation system.

Basic Connections and Setup

1. Connect your timecode source to the 02R.
2. Press the (AUTOMIX) button repeatedly to get to the “Main” screen.



There are six screens in the AUTOMIX display function. The “Automix Main” screen appears:

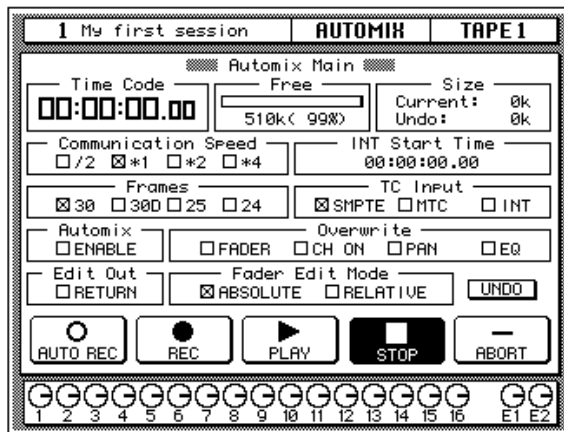

3. Use the CURSOR buttons to select the desired “Frame” rate and press the (ENTER) button.

The 02R supports four industry standard frame rates:

- 30 – 30 frames per second.
- 30D – 29.97 frames per second (30 drop frame).
- 25 – 25 frames per second.
- 24 – 24 frames per second.

These frame rates apply to all three timecode sources: SMPTE, MTC, and the internal clock.

4. Select the “TC Input” with the CURSOR buttons and press the (ENTER) button.

Select the timecode source from the three options:

- SMPTE timecode (the motion picture standard).
- MTC (MIDI timecode).
- Internal.

5. Use the CURSOR buttons to select the “Automix” ENABLE and press the (ENTER) button to switch it on.

The automation system will not function unless this check box is enabled.

6. Select the desired “Overwrite” items with the CURSOR buttons and press the (ENTER) button.

This field allows you to select the types of events that will be recorded. Only the items selected will be recorded. Choose from the following:

- FADER – channel level operations (fader or encoder) including auxiliary send levels.
- CH ON – [ON] button selections for each channel.
- PAN – pan position for each channel.
- EQ – equalizer selections for each channel.

Note: *Scene memories and all library recall operations will be recorded regardless of the settings of the “Overwrite” options.*

The other options on this screen are also important, but not for the purposes of this tutorial. See “Main Screen” on page 129 of the *User’s Guide* for more details.

Creating a New Automix

To record an entire mixing session with the Digital Recording Console 02R automation system, you must first create a new automix. When a new automix is created, the contents of the current automix (referred to as “events”) are deleted and the current automix is returned to its default settings.

If you want to keep the contents of the current automix, store them into an available memory location before proceeding.



1. Press the (AUTOMIX) button again.

The “Memory Management” screen appears:

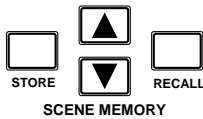
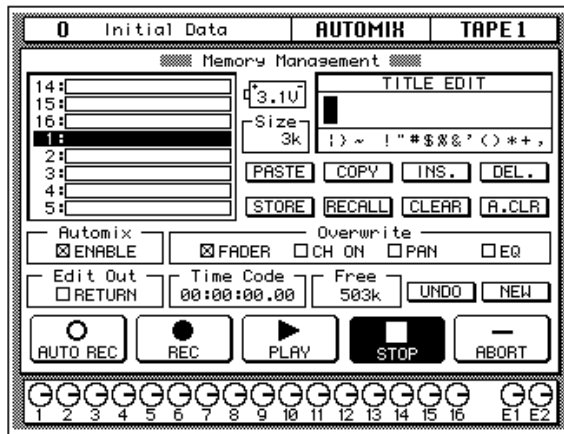

2. Use the SCENE MEMORY increment or decrement buttons to select your starting scene memory and press the (RECALL) button.

The selected scene memory is recalled.

Your mixdown scene memory should be stored with the [FLIP] button pressed so that the faders operate the tape returns rather than the input channels.

Note: You can customize your 02R so that the [FLIP] button status is ignored during scene memory recalls. In this case, you may need to press the [FLIP] button before you start recording your automix. See “Preferences” on page 162 of the User’s Guide for more information.

3. Set your starting levels for the mixdown and press the (STORE) button to update the scene memory.

The 02R will display a popup confirmation request message. Select the “EXECUTE” icon and press the [ENTER] button.

4. Use the CURSOR buttons to select the “NEW” control icon and press the (ENTER) button.

The 02R will display a popup confirmation request message asking if you want to make a new automix. The popup has two control icons: “CANCEL” and “EXECUTE”:



CANCEL is the default. To cancel the NEW operation, either press the [ENTER] button or wait about 10 seconds – the NEW operation will be automatically cancelled.

To create the new automix, use the CURSOR buttons to select the “EXECUTE” control icon and press the [ENTER] button. The last scene memory that was stored or recalled will be inserted at timecode location 00:00:00.00.

Recording the First Session



1. Press the (AUTOMIX) button repeatedly to get to the “Main” screen.

You can stop pressing the [AUTOMIX] button when the “Automix Main” screen reappears:

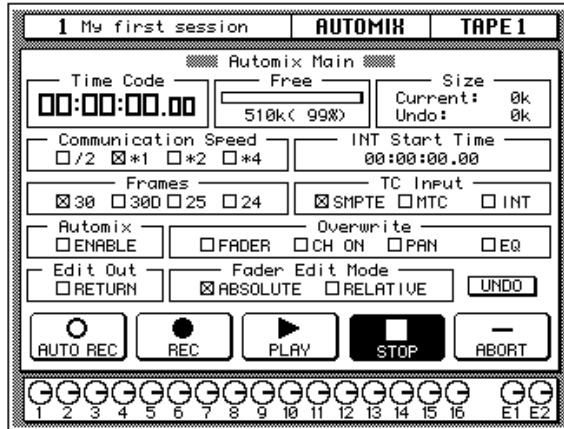

2. Select the “REC” (record) icon with the CURSOR buttons and press the (ENTER) button.

The “REC” icon will flash, indicating AUTOMIX RECORD READY status:

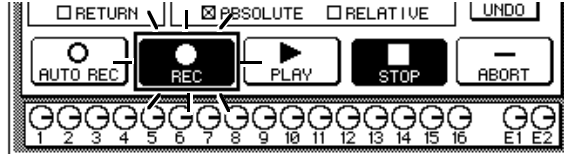

3. Press the (SEL) buttons for the tape return channels you want to record.

The LED inset in the selected channel [SEL] buttons flash indicating that they are armed for recording.

Note: Remember the scene memory you recalled has the [FLIP] function engaged. Therefore you should be selecting the [SEL] buttons in the row above the faders.

4. Start the device that is providing the timecode.

It should start from a location before the music starts.

Note: The 02R automix function will not respond correctly in cases where the source timecode starts at “23:59:30.00” and rolls over to “00:00:00.00”. The timecode must be continuous.

When timecode is received when the 02R is in AUTOMIX RECORD READY status, the "RECORD" icon will change to steady illumination (reverse video) and automix recording will begin. The timecode will be displayed in real-time in the "Time Code" field of the "Automix Main" screen.

Note: *If the timecode is not being displayed correctly in the "Time Code" field, check the following:*

- *Are your cables connected between the timecode source device and the 02R correctly?*
 - *Is the timecode source device setup correctly to output timecode?*
-

5. While monitoring the recording, operate the faders and other controls for the selected channels.

When you are recording the automix events, you can only operate the controls, specifically the faders, of the selected channels.

Note: *The 02R tries to prevent accidental level changes by "freezing" the faders that have not been selected. To avoid damaging the unit, do not attempt to operate the faders of channels that have not been selected.*

Automix Recording Notes

- When you are recording pan or equalizer changes you may find it more convenient to use the buttons and controls of the SELECTED CHANNEL block.
 - If you have selected more than one channel with the [SEL] buttons, the SELECTED CHANNEL controls can only adjust the channel that was selected last. The same applies for equalizer and dynamics processor operations. Because of these restrictions, you may find it more convenient to work on your automix recording one channel at a time when editing equalizer and pan data.
 - While you are recording automix events, you can select other 02R display functions, allowing you to adjust the parameters for multiple channels.
 - To record a recall operation from equalizer, dynamics, or channel libraries, press the [SEL] button for the channel to be changed, then use the corresponding display function to perform the recall operation. To record a recall operation from the effect libraries, use the [AUX7] or [AUX8] button to access the effect libraries.
-

6. When you have completed recording the automix session, use the CURSOR buttons to select the “STOP” icon and press the (ENTER) button.

You may find it faster and more convenient to stop the automix recording session by stopping the device that is providing the timecode. In this case, the effect is the same as if you selected the STOP function on the 02R:

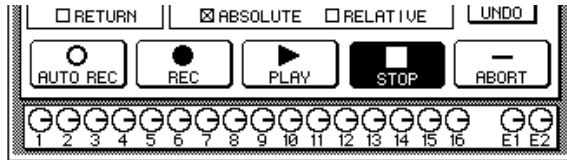

The “RECORD” icon will change to normal video and the “STOP” icon will be illuminated in reverse video. The events recorded during the automix session will be written to the current automix memory.

You can also discard the events recorded during the automix session by selecting the “UNDO” icon with the CURSOR buttons and pressing the [ENTER] button.

You can stop the automix recording session by selecting the “ABORT” icon with the CURSOR buttons and pressing the [ENTER] button. However, the events recorded during the automix session will be discarded.

Note: *The ABORT function must be used before an automix recording has stopped. Once the recording has stopped, the automix data will be updated and a new current mix is created. At this point after stopping an automix recording, the UNDO function can be used to retrieve the previous automix data.*

In most cases, punch-in edits or using the event editors can correct minor errors.

7. Stop the device that is providing the timecode.

Editing Automation Events

Overwriting Events

You can overwrite the events that have been recorded into the current automix. You can alter events on an already recorded channel or you can record new events onto another channel. For example, you may first record the faders for the rhythm section to the automix and then overwrite the fader operations for the lead parts and vocals.



1. If required, press the (AUTOMIX) button repeatedly to get to the “Main” screen.

You can stop when the “Automix Main” screen reappears:

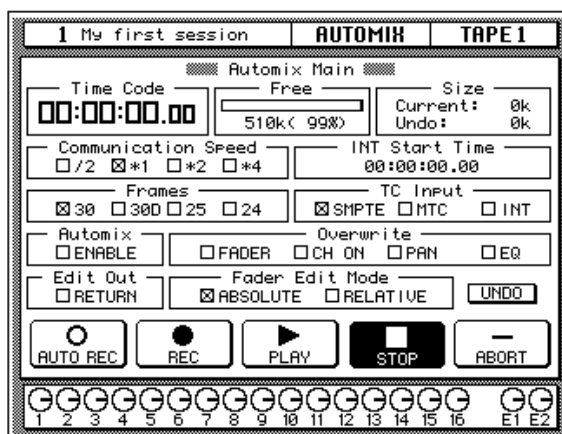

WARNING! Be careful that previously recorded events are not accidentally overwritten when you make these selections.

2. Use the CURSOR buttons to select the desired “Overwrite” items and press the (ENTER) button.

Note: If you double-click the [ENTER] button on a selected “Overwrite” item, only that item will be selected and the other items will be switched off.

3. Select the “RECORD” icon with the CURSOR buttons and press the (ENTER) button.

The “RECORD” icon will flash.

4. Press the (SEL) buttons for the tape return channels you want to overwrite.

It is very important that you be careful when you select the type of events and channels that will be overwritten. If you select the same channel and the same type of event as the last session, the previously recorded events will be deleted the moment the automix recording begins.

5. Start the device that is providing the timecode.

It should have been rewound and again start from a location before the music starts. The previously recorded automix will playback.

6. While monitoring the recording, adjust the parameters you want to overwrite.

7. When you have completed the automix overwriting session, use the CURSOR buttons to select the “STOP” icon and press the (ENTER) button.

You may find it faster and more convenient to stop the automix recording session by stopping the device that is providing the timecode. The effect is the same as if you selected the STOP function on the 02R.

The “RECORD” icon will change to normal video and the “STOP” icon will be illuminated in reverse video. The events recorded during the overwriting session will be added to the current automix memory.

8. Stop the device that is providing the timecode.

Punch-in Automix Data

If you made a mistake in just one portion of the automix, you can replace the erroneous data with a punch-in.



1. If required, press the (AUTOMIX) button repeatedly to get to the “Main” screen.
2. Use the CURSOR buttons to select the desired “Overwrite” items and press the (ENTER) button.
3. Select the “RECORD” icon with the CURSOR buttons and press the (ENTER) button.

The “RECORD” icon will flash.

4. Start the device that is providing the timecode.

It should have been rewound and again start from a location before the music starts. The previously recorded automix will playback, however, because you have not selected any channels, the 02R will remain in AUTOMIX RECORD READY status.

-
5. **Monitor the recording. At the punch-in location, press the (SEL) buttons for the tape return channels you want to fix.**

Recording will begin from the location where you pressed the [SEL] button.

Note: *From this point, new events will be recorded and previously existing events will be deleted.*

6. **While monitoring the recording, adjust the parameters you want to fix.**
7. **When you have finished adjusting the parameters, press the (SEL) buttons again.**

The 02R will return to AUTOMIX RECORD READY status.

Note: *If you do not adjust any parameters between the punch-in and punch-out points, any events of the selected type that were previously recorded there will have been deleted.*

8. **Use the CURSOR buttons to select the “STOP” icon and press the (ENTER) button.**

You may find it faster and more convenient to stop the automix recording session by stopping the device that is providing the timecode. The effect is the same as if you selected the STOP function on the 02R.

The “RECORD” icon will change to normal video and the “STOP” icon will be illuminated in reverse video.

9. **Stop the device that is providing the timecode.**

Editing Fader/Encoder Movements

If you are replacing erroneous fader/encoder data with a punch-in, the 02R allows you to monitor the differences with its “Fader Edit” screen.



1. **If required, press the (AUTOMIX) button repeatedly to get to the “Main” screen.**
2. **Use the CURSOR buttons to select the “FADER – Overwrite” item and press the (ENTER) button.**

3. Press the (AUTOMIX) button several times.

You can stop when the “Fader Edit” screen appears:

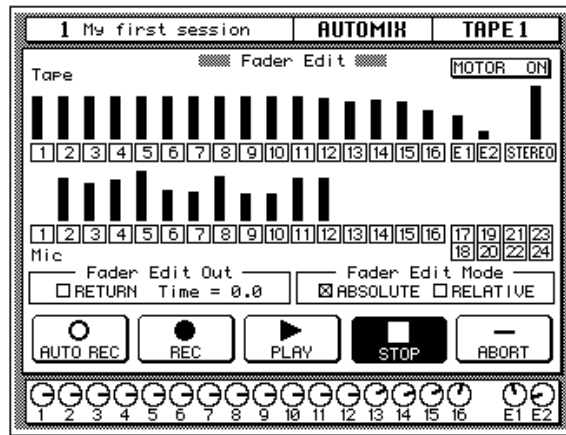

This display allows you to watch the fader movements as dynamic bargraphs. Several features make this display convenient to use while you perform detailed fader/encoder edits.

4. Use the CURSOR buttons to select “Fader Edit Out – RETURN” and press (ENTER) to change its value.

If the RETURN check box is not selected, you may want to move the fader back to its previously recorded level before you punch-out. If the RETURN check box is selected, the fader will automatically return to the previously recorded level when you punch out. The time it takes to return to the previous level is controlled by the “Time” field.

5. Select the “RECORD” icon with the CURSOR buttons and press the (ENTER) button.

The “RECORD” icon will flash.

6. Start the device that is providing the timecode.

The 02R will remain in AUTOMIX RECORD READY status.

7. Monitor the recording. At the punch-in location, press the (SEL) button for the tape return channel you want to edit.

Recording will begin from where you pressed the [SEL] button.

8. While monitoring the recording, adjust the fader you want to edit.

As you operate the fader, the display shows the previously recorded position as well as the new position. An arrow in the display indicates the

direction the fader has to be moved to return to the previously recorded position:

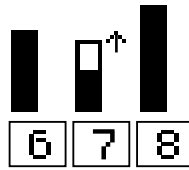

If the fader is moved to a position lower than the previously recorded position

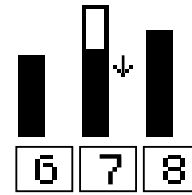

If the fader is moved to a position higher than the previously recorded position

9. When you have finished adjusting the fader, press the (SEL) button again.

The 02R will return to AUTOMIX RECORD READY status.

10. Use the CURSOR buttons to select the “STOP” icon and press the (ENTER) button.

You may find it faster and more convenient to stop the automix recording session by stopping the device that is providing the timecode. The effect is the same as if you selected the STOP function on the 02R.

11. Stop the device that is providing the timecode.

Off-Line Automix Editing

Editing Scene and Library Recall

You can edit the timing and contents of scene and library recall events that have been recorded into the current automix.



1. Press the (AUTOMIX) button several times.

You can stop when the “Event Edit (MEMORY)” screen appears:

1 My first session			AUTOMIX	TAPE 1
Event Edit(Memory)				
Time Code	Memory	Channel	INSERT	DELETE
00:00:00.00	SCENE 1			
00:00:30.08	EF.Lib. 3	EFF. 1		
00:01:27.24	CH.Lib. 2	TAPE 6		
00:01:58.11	CH.Lib. 3	TAPE 1		
00:02:05.04	CH.Lib. 1	TAPE 6		

1 2 3 4 5 6 7 8 9 10 11 12 13 14 15 16 E1 E2

This display consists of a table listing Time Code, Memory, and Channel of the scene and library recall events recorded into the current automix. It also has two control icons which allow you to insert (INSERT) or delete (DELETE) events.

2. Use the CURSOR buttons to select an event to edit.

The CURSOR buttons allow you to select the individual events (the selected event is called the “current event”) and to move across the table entry for each event. You can edit the following data:

- Time Code – the location of the event as a timecode value. The 02R sorts events by their timecode value.
- Memory – the type of the event. You can select from the following events:
 - SCENE – scene memory recall. The number indicates the scene number (from 0 to 64).
 - EQ.Lib. – equalizer library recall. The number indicates the equalizer library number (from 1 to 128).
 - DY.Lib. – dynamics library recall. The number indicates the dynamics library number (from 1 to 128).
 - EF.Lib. – effect library recall. The number indicates the effect library number (from 1 to 128).

- CH.Lib. – channel library recall. The number indicates the channel library number (from 1 to 64).
 - Channel – the channel that the recall applies to. For scene memory recall, this field is blank.
3. Rotate the encoder wheel to change the value at the current cursor location.

For timecode, you can independently adjust the hours, minutes, seconds, and frames values.

4. Use the CURSOR buttons to select the INSERT icon and press the (ENTER) button to insert an event.

A new event that is an exact duplicate of the current event will be inserted in the table. Use the CURSOR buttons to select the new event and adjust its values to suit. If you change its timecode value, the new event will be moved to its proper location in the time sequence.

5. Use the CURSOR buttons to select the DELETE icon and press (ENTER) to delete the current event.

Note: If the cursor is anywhere on the screen other than over the INSERT or DELETE icons, pressing the [ENTER] button will cause the cursor to move over the DELETE icon.

Editing Channel ON/OFF

You can edit the timing and contents of the channel on/off events that have been recorded into the current automix.



1. Press the (AUTOMIX) button again.

You can stop when the “Event Edit (CH ON)” screen appears:

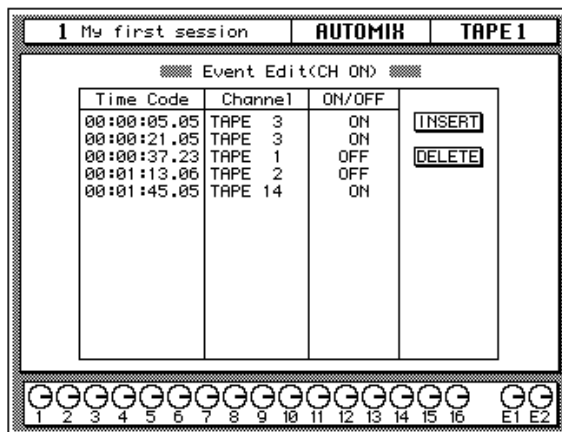

This display consists of a table listing Time Code, Channel, and ON/OFF of the channel on/off events recorded into the current automix. It also has two control icons which allow you to insert (INSERT) or delete (DELETE) events.

2. Use the CURSOR buttons to select an event to edit.

The CURSOR buttons allow you to select the individual events (the selected event is called the “current event”) and to move across the table entry for each event. You can edit the following data:

- Time Code – the location of the event as a timecode value. The 02R sorts events by their timecode value.
- Channel – the channel that the on/off event applies to.
- ON/OFF – the ON or OFF status of the channel.

3. Rotate the encoder wheel to change the value at the current cursor location.

4. Use the CURSOR buttons to select the INSERT icon and press the (ENTER) button to insert an event.

A new event that is an exact duplicate of the current event will be inserted in the table. Use the CURSOR buttons to select the new event and adjust its values to suit. If you change its timecode value, the new event will be moved to its proper location in the time sequence.

5. Use the CURSOR buttons to select the DELETE icon and press (ENTER) to delete the current event.

Note: *If the cursor is anywhere on the screen other than over the INSERT or DELETE icons, pressing the [ENTER] button will cause the cursor to move over the DELETE icon.*

Deleting Events

You can delete specific events that have been recorded into the current automix. You can select a timecode range, the channels desired, and the specific events you want to delete.



1. Press the (AUTOMIX) button again.

You can stop when the “Event Extract” screen appears:

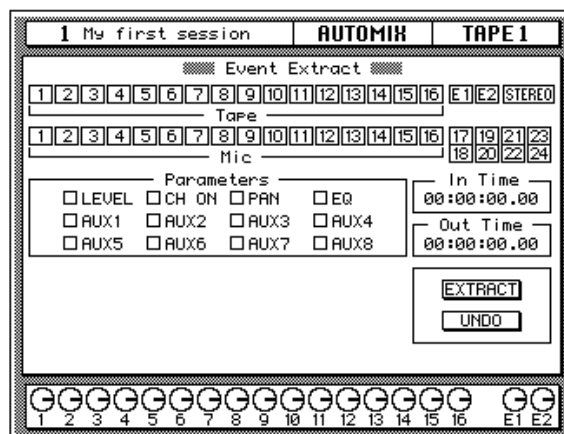

2. Use the CURSOR buttons to select the channel or channels to delete.

You can also use the [SEL] buttons to select channels. The following channels may be selected:

- Tape 1 through 16 – the tape return channels.
- E1 and E2 – the effect return channels.
- STEREO – the stereo bus.
- Mic 1 through 16 – the MIC/LINE input channels.
- 17/18 through 23/24 – the stereo pair line input channels.

3. You must press the (ENTER) button to switch a channel on or off.

If you double-click the [ENTER] button on a selected channel, that channel will be turned on and all the other channels turned off, or all the channels will be turned on. The 02R displays a confirmation popup which allows you to select one channel or all channels:



Use the CURSOR buttons to select “ONE” to turn one channel on and all the other channels turned off, or select “ALL” to turn all the channels on. Press the [ENTER] button to execute your choice.

4. Select the “Parameters” to delete with the CURSOR buttons and press the (ENTER) button to switch a parameter on or off.

You can select one or more parameters to delete from the following:

- LEVEL – fader/encoder events, controlling the input level of a channel.
- CH ON – channel on/off events.
- PAN – pan operation events of a channel.
- EQ – equalization operation events of a channel.
- AUX1 through AUX8 – fader/encoder events, controlling the auxiliary send level of a channel.

If you double-click the [ENTER] button on an event type, that event type will be turned on and all the other types turned off, or all event types will be turned on. The 02R displays a confirmation popup which allows you to select one channel or all channels:



Use the CURSOR buttons to select “ONE” to turn one event type on and all the other types turned off, or select “ALL” to turn all the event types on. Press the [ENTER] button to execute your choice.

5. Use the CURSOR buttons to select the “In Time” and rotate the encoder wheel to specify the timecode location at which to begin deleting events.

You can independently adjust the timecode hours, minutes, seconds, and frames values.

6. Select the “Out Time” with the CURSOR buttons and rotate the encoder wheel to specify the timecode location at which to stop deleting events.

The 02R will delete all the specified events starting from the “In Time” timecode location up to, but not including, events at the “Out Time” timecode location.

7. Use the CURSOR buttons to select the “EXTRACT” control icon and press the (ENTER) button.

The specified events will be removed from the current automix from the starting timecode location up to the stopping timecode location.

8. If you decide you did not want to delete the events just removed from the current automix, you can use the CURSOR buttons to select the “UNDO” control icon and press the (ENTER) button.

Be aware that you can only UNDO the last delete operation you performed!

Using the AUTOMIX Library

Storing an Automix

The Digital Recording Console 02R has 16 automix program locations (1 through 16) for you to store the current automix. The following instructions show you how to store your automix program in the library.



1. Press the (AUTOMIX) button until the “Memory Management” screen appears:

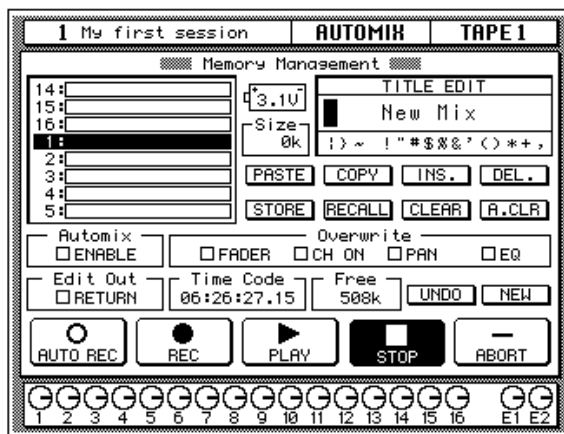

2. Use the CURSOR buttons to select the TITLE EDIT box.
3. Select the individual character positions with the CURSOR buttons. Use the encoder wheel to select the characters.

You can create a name of up to 16 characters long. It can contain any of the following characters:

	!	“	#	\$	%	&	'	()	*	+	,	-	.	/
0	1	2	3	4	5	6	7	8	9	:	;	<	=	>	?
@	A	B	C	D	E	F	G	H	I	J	K	L	M	N	O
P	Q	R	S	T	U	V	W	X	Y	Z	[\]	^	_
`	a	b	c	d	e	f	g	h	i	j	k	l	m	n	o
p	q	r	s	t	u	v	w	x	y	z	{		}	~	

Move the cursor to the first character position with the CURSOR buttons. Rotate the encoder to select the desired character. Move the cursor to the second character position and repeat:

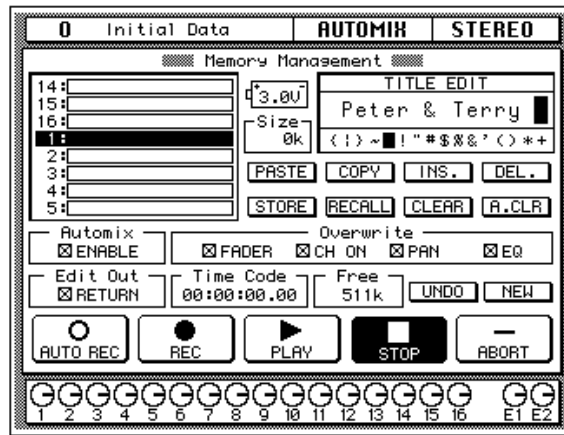

You can select the “INS.” control icon to insert a space (blank) at the current cursor location in the TITLE EDIT box. Select the icon with the CURSOR buttons and press the [ENTER] button. The “DEL.” control icon is used to delete the character under the current cursor location in the TITLE EDIT box.

Note: The “COPY” and “PASTE” control icons allow you to select the title from another automix program and paste it into your program for subsequent editing. These icons only copy the title. See “AUTOMIX Name Edit Functions” on page 134 of the User’s Guide.

Automix Memory

Automix memory is shared between the current automix and the stored automix programs. This means that a “Memory Full” error message could appear even though there are empty automix locations left. A complex automix, containing many events, may exceed the capacity of the 02R to store. If this occurs, backup and delete any unused automix programs and attempt the STORE operation again.

The default capacity of the 02R automation function is 512Kbytes. You can expand the memory to 1.5Mbytes or 2.5Mbytes by installing the optional ME4M memory expansion kits.

4. Use the CURSOR buttons to select the STORE icon. Rotate the encoder wheel to select an automix program and press the (ENTER) button.

The 02R will display a popup confirmation request message asking if you want to store your settings in the selected automix program. The popup has two control icons: “CANCEL” and “EXECUTE”.

CANCEL is the default. To cancel the STORE operation, either press the [ENTER] button or wait about 10 seconds – the STORE operation will be automatically cancelled.

To store your settings, use the CURSOR buttons to select the “EXECUTE” control icon and press the [ENTER] button. The automix program is stored.

Note: *If you decide you do not like an automix program after you have stored it, it is very easy to overwrite it by creating a new automix and storing it to the same location. Conversely, it is also very easy to accidentally overwrite a valued automix program.*

YOU SHOULD ALWAYS BE CAREFUL WHEN THE 02R DISPLAYS ITS CONFIRMATION POPUP MESSAGE!

Recalling an Automix



1. Press the (AUTOMIX) button until the “Memory Management” screen appears:

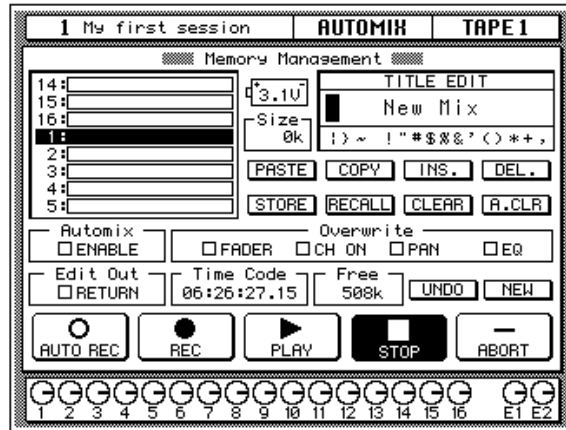

2. Use the CURSOR buttons to select the RECALL icon. Rotate the encoder wheel to select an automix program.

The 02R will scroll through the available automix programs. The program that is highlighted is the program that will be recalled when you press the [ENTER] button.

3. Press the (ENTER) button.

The 02R will display a popup confirmation request message asking if you want to recall selected automix program. The popup has two control icons: “CANCEL” and “EXECUTE”.

CANCEL is the default. To cancel the RECALL operation, either press the [ENTER] button or wait about 10 seconds – the RECALL operation will be automatically cancelled.

To recall the automix, use the CURSOR buttons to select the “EXECUTE” control icon and press the [ENTER] button. The automix program is recalled.

Note: *When you recall an automix program, you are overwriting the current automix. Make sure that you have backed up or stored the current automix just in case.*

YOU SHOULD ALWAYS BE CAREFUL WHEN THE 02R DISPLAYS ITS CONFIRMATION POPUP MESSAGE!

Index

A

automation system

automix memory	68
AUTOMIX RECORD READY	73
connections and setup	69
create a new automix	71
deleting events	84
description	68
editing channel ON/OFF	82
editing fader/encoder movements	78
editing scene and library recall	81
naming an automix	86
overwriting events	76
punch-in recording	77
recalling an automix	89
recording	73
storing an automix	86
timecode	
internal clock	69
MTC (MIDI timecode)	69
SMPTE	69
timecode errors	74
AUTOMIX button	69
AUTOMIX display function	
ABORT icon	75
Automix Main screen	
“Automix” ENABLE check box	70
“Frame” rate box	70
“Overwrite” check boxes	70
“TC Input” box	70
Event Edit(CH ON) screen	
Channel field	83
DELETE icon	83
INSERT icon	83
ON/OFF field	83
Time Code field	83
Event Edit(Memory) screen	
Channel field	82
DELETE icon	82
INSERT icon	82
Memory field	81
Time Code field	81
Event Extract screen	
channel icons	84
EXTRACT icon	85
“In Time” field	85
ONE/ALL – confirmation popup	84
“Out Time” field	85
“Parameters” check boxes	85
popup – ALL icon	84
popup – ONE icon	84
UNDO icon	85
Fader Edit screen	
Fader Edit Out – RETURN check box	79
Fader Edit Out – Time field	79
Memory Management screen	
COPY icon	87
DEL. (delete) icon	87
INS. (insert) icon	87
NEW icon	72
NEW – confirmation popup	72
PASTE icon	87
popup – CANCEL icon	72
popup – EXECUTE icon	72
RECALL icon	89
RECALL – confirmation popup	89
STORE icon	87
STORE – confirmation popup	87
TITLE EDIT box	86
UNDO icon	75
REC (record) icon	73
STOP icon	75
auxiliary send	
description	42
fader status	43
pre or post fader status	43
send level	44
send status	43
AUX 1 display function	
PRE/POST icon	44
AUX 7 display function	
Effect Edit screen	
LIB icon	49
parameter icons	51
Effect Library screen	
COPY icon	53
DEL. icon	53
INS. icon	53
PASTE icon	53
popup – CANCEL icon	53
popup – EXECUTE icon	53
RECALL icon	50
STORE icon	53

EQUALIZER display function	
ATT (attenuation) icon	26
EQ ON icon	25
F (frequency) icon	27
G (gain) icon	25
Q (bandwidth) icon	28
equalizer library	
description	30
recalling an EQ program	30
storing an EQ program	32
undoing a recall	32
EQUALIZER Library display function	
COPY icon	34
DEL. (delete) icon	34
INS. (insert) icon	34
LIB icon	31
PASTE icon	34
popup – CANCEL icon	34
popup – EXECUTE icon	34
program list	31
program "U" (UNDO buffer)	32
RECALL icon	30
STORE icon	33
STORE – confirmation popup	34
TITLE EDIT box	33
F	
fader levels, setting	20
fader status	43
FADER STATUS indicator	
AUX LED	43
AUX number	43
FLIP button	44
G	
gain	
GAIN control	21
20dB (pad) switch	21
setting	21
GAIN control	21
I	
input connectors 1 through 8	14
internal effects	
adjusting the effect return	47
description	46
editing effects	50
editing the program name	52
effect return clipping	48
pre or post fader status	47
recalling effects programs	49
send levels, setting	46
storing effects programs	51
M	
manuals	
<i>Getting Started Guide</i>	3
<i>User's Guide</i>	3
METER button	21
METER display function	21
monitor mix, creating	45
monitor source, selecting	20
multi-effects stereo processors	46
O	
ON button (mute)	23
optional input/output cards	
AES/EBU (CD8-AE/CD8-AE-S)	35
Alesis ADAT (CD8-AT)	35
Analog AD/DA (CD8-AD)	35
TASCAM TDIF-1 (CD8-TDII)	35
YAMAHA (CD8-Y)	35
P	
20dB (pad) switch	21
pan	
adjusting the pan	38
GANG mode	39
pairing channels	39
pan positions	39
PAN button	38
PAN controls	38
PAN display function	
GANG indicator	39
PAN icon	39
peak hold function	22
Ø/ATT button	22
Ø/ATT display function	22
PHONES jack	14
PHONES LEVEL control	20
POWER switch	16

R	
routing	
direct outputs.....	35
eight output buses.....	35
selecting the routes	37
ROUTING button.....	37
ROUTING display function	
ROUTE icons.....	37
S	
SCENE display function	
COPY icon.....	64
DELETE icon.....	64
INSERT icon.....	64
PASTE icon.....	64
title edit box	64
scene memories	
description.....	62
edit buffer	62
naming a scene memory	63
popup – CANCEL icon	63
popup – EXECUTE icon.....	63
recalling a scene memory.....	65
Scene Memory 0 (0 Initial Data).....	62
store – confirmation popup	62
storing a scene memory	62
undo buffer	62
SCENE MEMORY buttons	17
decrement (▼).....	62
increment (▲)	62
RECALL.....	65
STORE.....	62
SCENE MEMORY LED.....	23
edit indicator.....	23
SEL button.....	21
SELECTED CHANNEL – AUX	
AUX 1 button.....	43
AUX 5 button.....	45
AUX 7 button.....	47
LED bargraph	44
ON button	43
SEND LEVEL rotary encoder.....	44
SELECTED CHANNEL – EQUALIZER	
EQ ON button.....	25
F (frequency) rotary encoder.....	27
G (gain) rotary encoder	25
HIGH/LPF button	26
H-MID button.....	26
L-MID button.....	26
LOW/HPF button.....	25
Q (bandwidth) rotary encoder	28
SELECTED CHANNEL – PAN	
LED bargraph	39
L/ODD button.....	39
pan rotary encoder.....	39
R/EVEN button.....	39
SELECTED CHANNEL – ROUTING	
ROUTING buttons	37
STEREO OUT connectors	14
STUDIO group	
AUX 5 button.....	45
synchronization.....	16
T	
talkback system	45
V	
VIEW button	47
VIEW display function	
EQ graph	48
PAN icon	48
Ø/ATT controls.....	47
ROUTING icons	48



DIGITAL RECORDING CONSOLE

Getting Started Guide

Sections

1	Controls and Connections.	1
2	User Interface	17
3	Mixing and Monitoring.	25
4	MIXING Display Functions	31
5	Dynamics	61
6	Auxiliary Channels	83
7	Internal Effects	89
8	Scene Memories.	113
9	Automation	123
10	MIDI	141
11	Groups and Pairs	147
12	Digital I/O, Setup, and Utilities.	153
13	Installing Options	171
14	Specifications	191
15	Glossary.	225
	Index	233

Contents

1	Controls and Connections.	1
	Front Panel	2
	Rear Panel.	11
	Block Diagram	15
2	User Interface	17
	About the User Interface	18
	DISPLAY ACCESS Buttons	18
	Display	20
	CURSOR Buttons	20
	Encoder Wheel.	21
	ENTER Button	21
	SCENE MEMORY Buttons	21
	Display Functions	22
	SELECTED CHANNEL Controls	23
3	Mixing and Monitoring.	25
	Analog Inputs	26
	Phantom Power.	26
	Pad.	27
	GAIN Controls.	27
	SEL Buttons	27
	ON Buttons.	28
	Faders	28
	Analog Outputs.	29
	Monitor Selector Switches	29
	Monitor Level Controls	30
4	MIXING Display Functions	31
	Phase and Attenuation.	32
	Delay	34
	Pan and Balance.	36
	Stereo-Pair Pans.	37
	Stereo Width	37
	PAN controls	38
	Routing	39
	ROUTING buttons	40

	Metering	41
	View	44
	Channel Library	47
	Equalizer	49
	EQUALIZER controls	51
	Equalizer Programs	52
	Equalizer Library	53
	Preset EQ Program Parameters	56
5	Dynamics	61
	Dynamics Processors	62
	Preset Dynamics Programs	62
	Compressor	63
	Expander	65
	Compander	66
	Gate and Ducking	67
	DYNAMICS Display Function	69
	Patching in a Processor	70
	Dynamics Processor Meters	71
	KEY IN and LINK Indicators	72
	Dynamics Library	73
	Preset Dynamics Program Parameters	76
6	Auxiliary Channels	83
	About the 02R Auxiliaries	84
	The AUX Buttons	85
	Stereo Input Channels	87
	AUX [ON] Button	87
	AUX Pre or Post	87
	Monitor Mix	88
7	Internal Effects	89
	About Effects	90
	Preset Effects Programs	91
	AUX 7 and AUX 8	92
	Effects	94
	Effects Library	95
	Preset Effects Program Parameters	98

8	Scene Memories	113
	What are Scene Memories?	114
	What is Stored in a Scene Memory?	115
	What is the Edit Buffer?	115
	Initial Data and UNDO Memory	115
	Storing Mix Scenes	116
	Naming a Scene Memory	117
	Recalling Scene Memories	119
	Fader Recall Safe	120
	Fade Time	121
9	Automation	123
	What is the Automation Function?	124
	What is Timecode?	126
	Automation Function	128
	Main Screen	129
	Memory Management	133
	Fader Edit	136
	Event Edit (MEMORY)	138
	Event Edit (CH ON)	139
	Event Extract	140
10	MIDI	141
	MIDI and the 02R	142
	Setup	143
	Program Change Assign	144
	Bulk Dump/Request	145
11	Groups and Pairs	147
	Grouping Faders	148
	Grouping Mutes	149
	Pairing Channels	150
12	Digital I/O, Setup, and Utilities	153
	Word Clock Select	154
	Input Signal Select	156
	Cascade Configuration	157
	Dither	159
	Solo	160
	Preferences	162

	Oscillator	165
	Emphasis Monitor	166
	Channel Status Monitor	167
	Battery Check	169
	02R System Initialization	170
13	Installing Options	171
	Digital Recording Console 02R Options	172
	Installing 02R Options	175
	Analog I/O Card – AD/DA (CD8-AD)	178
	Digital I/O Card – AES/EBU (CD8-AE/CD8-AE-S)	179
	Digital I/O Card – ADAT (CD8-AT)	181
	Digital Cascade Kit (CD8-CS)	183
	Digital I/O Card – TDIF-1 (CD8-TDII)	187
	Peak Meter Bridge (MB02)	189
14	Specifications	191
	General Specifications	192
	Input Specifications	198
	Output Specifications	199
	Digital Input and Output Specifications	199
	Dimensions	200
	Options	201
	Troubleshooting	202
	Error Messages	203
	MIDI Data Format	206
	Parameter Change and Request Format	209
	Bulk Dump and Request Format	213
15	Glossary	225
	References and Further Reading	231
	Index	233
	MIDI implimentation chart	241
	User Setting Sheet	242

1

Controls and Connections

In this chapter...

Front Panel 2

Rear Panel..... 11

Block Diagram 15



Front Panel

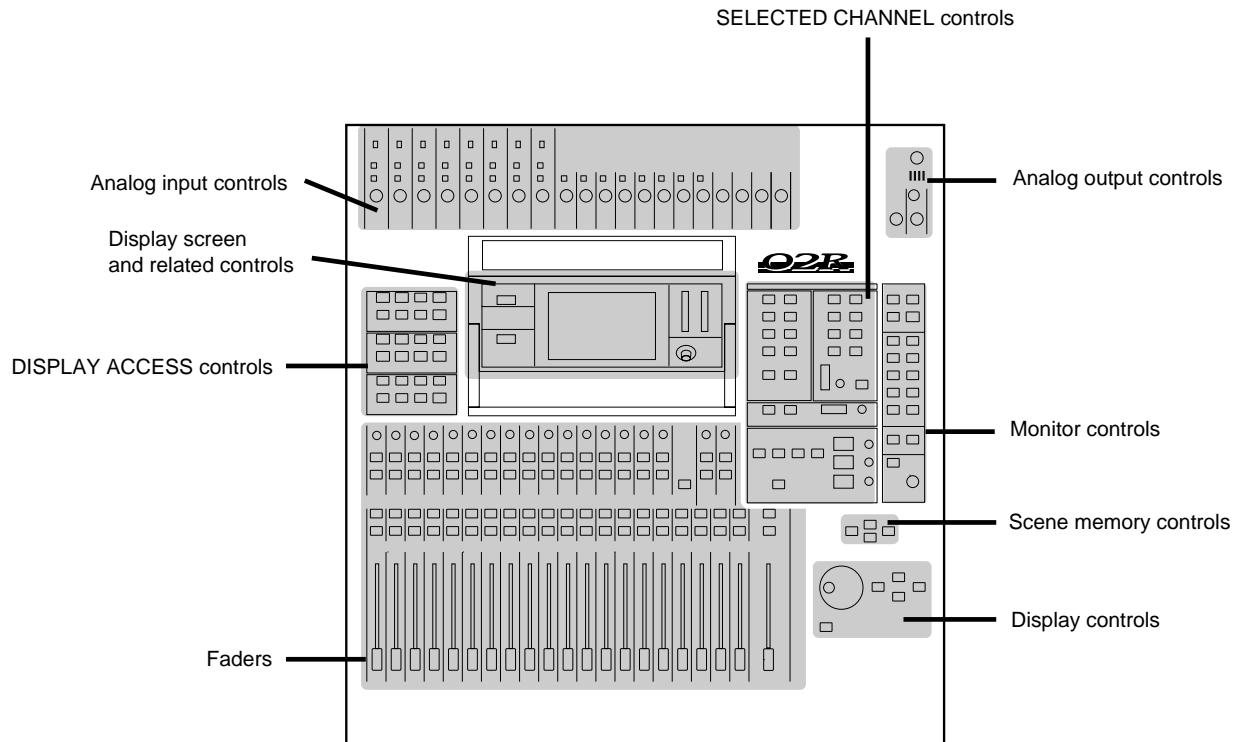

Analog input controls

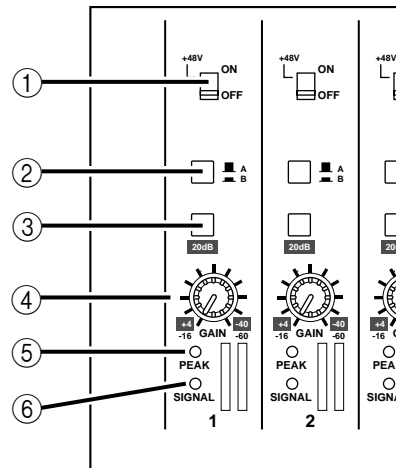

1. Phantom switches (channels 1 to 8)

These switches turn the +48 V DC phantom power ON and OFF for the XLR-3-31 connectors.

2. A/B switches (channels 1 to 8)

These switches select between the XLR-3-31 connectors and the phone connectors.

3. 20dB (pad) switches (channels 1 to 16)

These switches attenuate the input signal by 20 dB.

4. GAIN controls

These controls adjust the gain of the input preamp.

The analog input controls are not controlled or stored by the 02R automation and scene memory functions. To allow easy recall of the gain setting, the controls are detented.

5. PEAK LED

This red LED illuminates when the input signal exceeds 3 dB below clipping.

It is acceptable if this LED illuminates occasionally. However, if it is continuously illuminated, the input preamp is being overloaded and clipping distortion will result.

6. SIGNAL LED

This green LED illuminates when the input signal exceeds 10 dB below nominal.

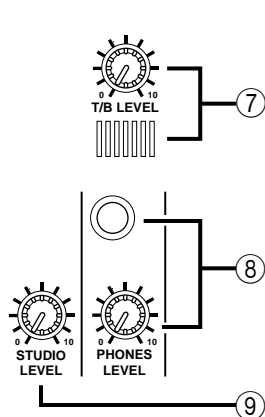

Analog output controls

7. **T/B LEVEL control and microphone**
This control sets the volume level of the built-in talkback microphone.
8. **STUDIO LEVEL control**
This control sets the level of the signal sent to the STUDIO MONITOR OUTPUT connectors.
9. **PHONES LEVEL control and connector**
This control sets the level of signal output to a pair of stereo headphones plugged into the connector.

DISPLAY ACCESS controls

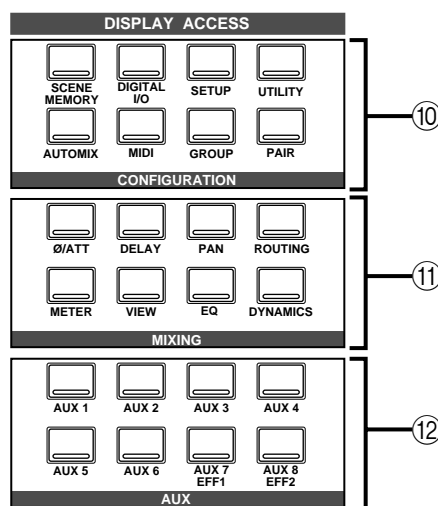

10. **CONFIGURATION buttons**
These buttons access the corresponding Display function.

Button	Description
SCENE MEMORY	Store and recall mix scenes.
DIGITAL I/O	Define the digital interconnections and word clock source, cascade parameters, and dither characteristics.
SETUP	Set SOLO status and preferences
UTILITY	Define oscillator, check battery status.
AUTOMIX	Store and recall automation programs.
MIDI	Set the MIDI channels and tables. Control bulk data transfers.
GROUP	Set up the fader groups.
PAIR	Set up channel pairs.

11. MIXING buttons

These buttons access the corresponding Display function.

Button	Description
Ø/ATT	Set phase and attenuation.
DELAY	Set the channel delay.
PAN	Set the pan position.
ROUTING	Set the channel routing.
METER	Meter the levels from the individual input channels, the tape and effect return channels, the 8 main busses, and the 8 auxiliary busses.
VIEW	View and set all the parameters for the selected channel and access the channel library.
EQ	Set the equalization and access the EQ library.
DYNAMICS	Set the dynamics and access the dynamics library.

12. AUX buttons

These buttons access the corresponding Display function.

Button	Description
AUX 1 to 6	Set the channel levels to the auxiliary busses.
AUX 7 and 8	Set the channel levels to the auxiliary busses and set the effect parameters.

Display screen and related controls

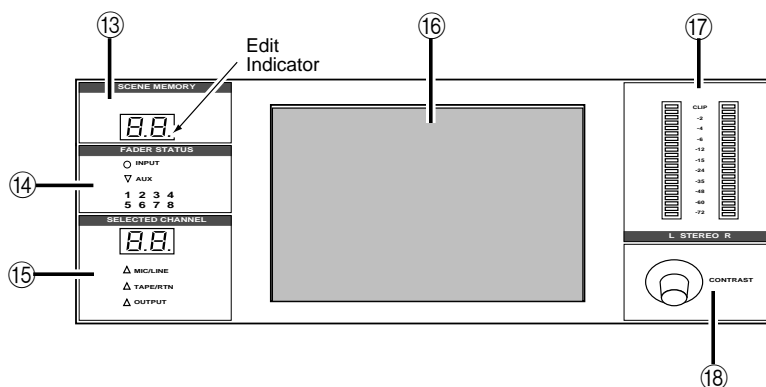

13. SCENE MEMORY indicator

This 2-digit (7-segment) LED shows the currently selected Scene Memory program. It also contains the Edit Indicator, which will start flashing when the current mix scene is first adjusted.

14. FADER STATUS indicators

These LED indicators show the status of the faders. When you select the AUX buttons ([AUX 1] through [AUX 8]), the AUX LED will illuminate to indicate the faders are used to set the auxiliary send levels. The currently selected AUX button is also indicated here.

Normally, the INPUT LED is illuminated.

15. SELECTED CHANNEL indicators

The 2-digit (7-segment) LED shows the currently selected channel number for the SELECTED CHANNEL controls. The three LEDs below indicate the status of the selected channel: MIC/LINE, TAPE/RTN, or OUTPUT.

16. Graphical display screen

This is the 320 × 240 pixel, CFL-backlight, graphical display screen. It displays the system functions and their parameter values both graphically and numerically.

17. Stereo output level meters

These stereo meters consist of 21-elements per channel.

18. Contrast control

This control adjusts the contrast of the graphical display screen.

SELECTED CHANNEL controls

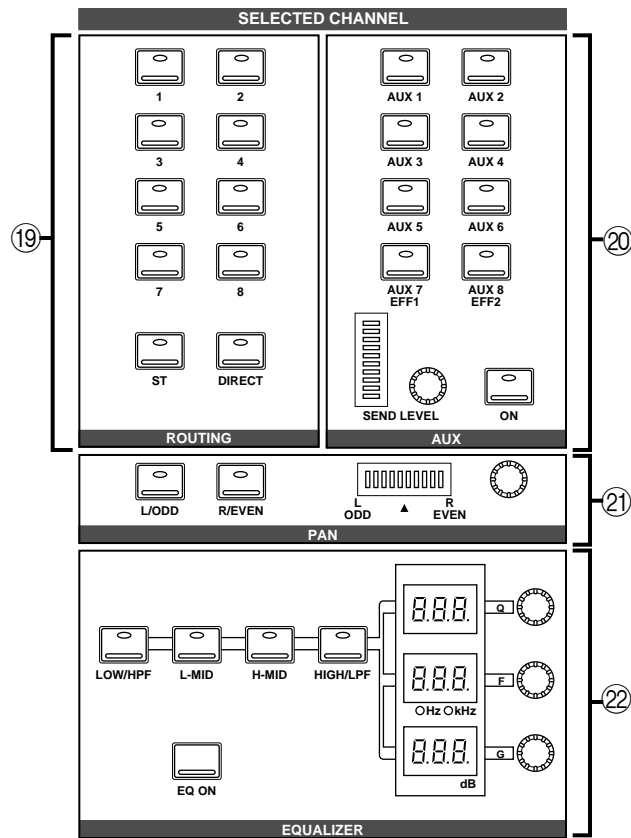

19. ROUTING buttons

These buttons set the routing for the currently selected channel.

20. AUX buttons and controls

These buttons and controls set the auxiliary send channel and level for the currently selected channel.

21. PAN buttons and controls

These buttons and controls set the pan position for the currently selected channel.

22. EQ buttons and controls

These buttons and controls set the equalization for the currently selected channel.

Monitor controls

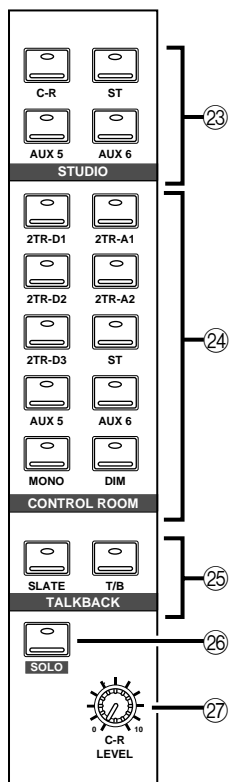

- 23. STUDIO buttons**
 These buttons select the monitor signal sent to the STUDIO MONITOR OUTPUT connectors.
- 24. CONTROL ROOM buttons**
 These buttons select the monitor signal sent to the C-R MONITOR OUT connectors.
- 25. TALKBACK buttons**
 These buttons allow the control room to talk to the studio and to SLATE control room information to the output busses.
- 26. SOLO button**
 This button activates the SOLO bus. Use the ON buttons to select a channel to monitor.
- 27. C-R LEVEL**
 This control sets the level of the C-R MONITOR OUT connectors.

Faders

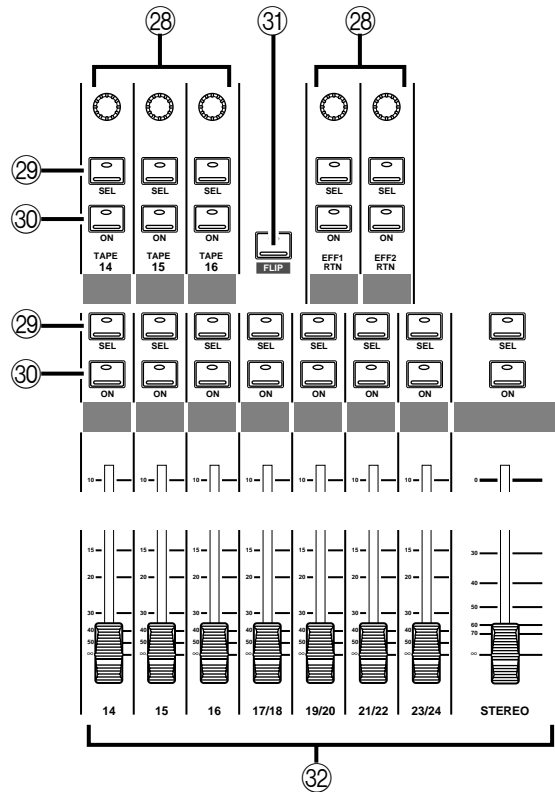

28. Tape and Effect return controls

These continuously rotary controls set the level of the tape and effect returns. The current level of a return channel is shown by the corresponding icon on the bottom of the display screen.

29. SEL buttons

These buttons select the individual channels. When you press on of the SEL buttons, the LED in the centre of the button is illuminated.

30. ON buttons

These buttons switch the selected channel ON or OFF. When a channel is ON, the LED in the centre of the button is illuminated.

When you press the SOLO button (engage the SOLO function), these buttons are used to select the monitor channels. The LEDs inset in the buttons are switched off. Press the ON buttons to select channels to send to the SOLO bus. When you press the SOLO button again (cancel the SOLO function), the prior channel status is restored and the appropriate LEDs are switched back on.

31. FLIP button

This button interchanges the functions of MIC/LINE channels 1 to 16 and TAPE RETURN channels 1 to 16. This allows you to set the tape return levels with the Faders rather than the Tape Return controls.

32. Faders

These 100mm motorized faders set the channel level for the corresponding channel.

The faders will position themselves automatically when a scene memory snapshot is recalled, a number of faders are grouped or paired, or an automation mix is played back.

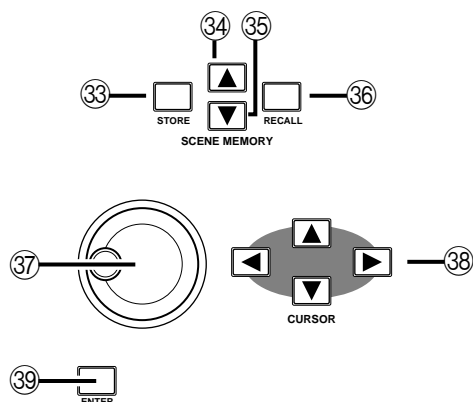
Scene memory controls**33. STORE button**

This button stores the current mixer settings into the current scene memory location.

34. Increment button

This button selects the next scene memory.

35. Decrement button

This button selects the previous scene memory.

36. RECALL button

This button recalls the current scene memory. All mixer settings are restored to the positions recorded in the scene memory snapshot.

Display controls**37. Encoder wheel**

This control adjusts the value of the currently selected parameter. Rotate it clockwise to increase the value, and counterclockwise to decrease the value.

38. CURSOR buttons

These buttons select the parameters and options on the display screen.

39. ENTER button

This button either confirms a parameter setting made with the Encoder wheel or it sets a parameter that only has two possible values.

Rear Panel

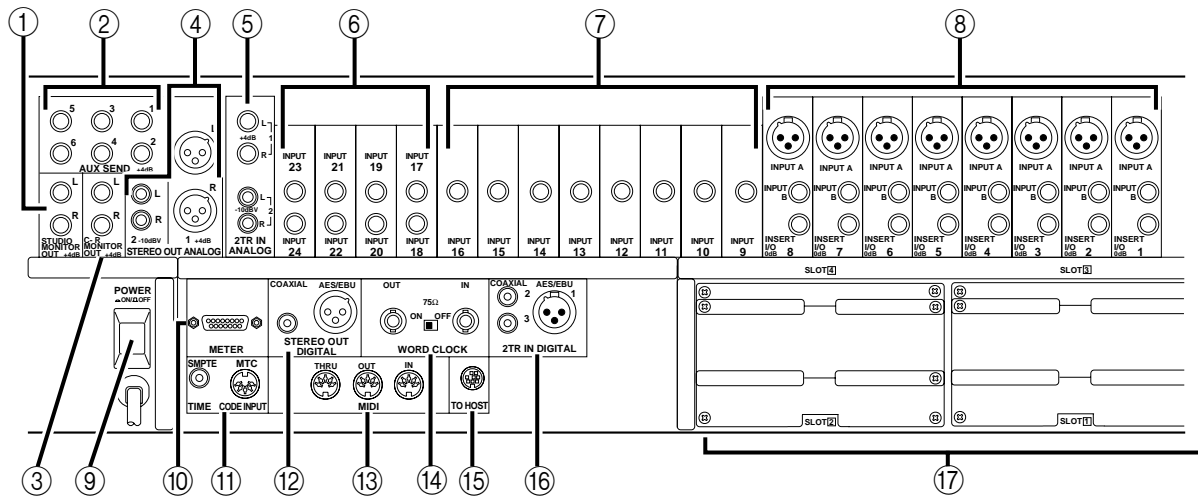

Phantom Power Warning
To prevent hazard or damage, connect only microphones and cables that conform to the IEC268-15A standard.

1. STUDIO MONITOR OUT connectors

These are balanced 1/4" phone jacks with a +4 dB nominal output level. They output the monitor signals for the studio, and can be connected to the inputs on a monitor or headphone amplifier.

The monitor signal source is determined by the STUDIO buttons. The output level is set using the STUDIO LEVEL control.

2. AUX SEND connectors

These are unbalanced 1/4" phone jacks with a +4 dB nominal output level. They output the signals from AUX busses 1 to 6, and can be used to feed external effects processors, foldback amplifiers, or multitrack recording equipment.

3. C-R MONITOR OUT connectors

These are balanced 1/4" phone connectors with a +4 dB nominal output level. They are wired TRS. They output the signal selected by the CONTROL ROOM buttons.

4. STEREO OUT ANALOG (1 and 2) connectors

STEREO OUT (1) are balanced XLR-3-32 type connectors with a +4 dB nominal output level. STEREO OUT (2) are unbalanced RCA/phono jacks with a -10 dBV nominal output level.

These connectors output the main stereo signals for recording, and can be connected to cassette and other analog recorders.

5. 2TR IN ANALOG (1 and 2) connectors

2TR IN (1) are balanced phone jacks with a +4 dB nominal input level. 2TR IN (2) are unbalanced RCA/phono jacks with a -10 dBV nominal input level.

Signals input here are fed through to the CONTROL ROOM buttons (24) and are monitored in the control room or the studio. The outputs of a 2-track master recorder can be connected here for confidence monitoring and playback.

6. Stereo input channels (17 to 24)

These are pairs of balanced 1/4" phone jacks with a -40 to +4 dB nominal input level. You can connect the return from a stereo effects unit (for example the YAMAHA D5000 digital delay) to these input channels.

The signals from 2TR IN DIGITAL (1) can be routed to channels 17/18 and the signals from 2TR IN DIGITAL (2) can be routed to channels 19/20.

7. Input channels (9 to 16)

These are balanced phone jack connectors. The nominal input level is -60 dB to +4 dB. Wiring is sleeve-ground, tip-hot (+), and ring-cold (-). They can be used with balanced or unbalanced plugs.

8. Input channels (1 to 8)

INPUT A (1 to 8) are balanced XLR-3-31 type connectors. The nominal input level is -60 dB to +4 dB. They are wired according to the IEC 268 standard: Pin 1-ground, pin 2-hot (+), and pin 3-cold (-). Phantom powering is available for condenser type microphones.

Note: *Make sure that the balanced devices you plug into the input connectors also use pin 2-hot, pin 3-cold wiring. If they are wired differently, undesirable phase shifts may occur. However, you can invert the phase of an input signal with the 02R.*

INPUT B (1 to 8) are balanced phone jack connectors. The nominal input level is -60 dB to +4 dB. Wiring is sleeve-ground, tip-hot (+), and ring-cold (-). They can be used with balanced or unbalanced plugs. See the note above.

INSERT I/O (1 to 8) are unbalanced phone jack connectors. Both the nominal output and input levels are +0 dB. Wiring is sleeve-ground, tip-out, and ring-in. Connect external dynamic processors and other analog devices here.

-
- 9. POWER switch**
This is a push-type power switch. It is recessed to prevent accidental operation. Press once to power ON; press again to power OFF.
- 10. METER connector**
This 15-pin Dsub connector sends the meter information from each of the input channels, tape and effect return channels, auxiliary channels, etc., to the optional meter bridge (MB02).
- 11. TIME CODE IN SMPTE connector**
This RCA/phone jack is a nominal -10 dB/ $10k\Omega$ connector. It accepts standard SMPTE time code to synchronize the 02R to an external time code generator.
- MTC connector**
This is a standard 5-pin DIN-type MIDI connector. It is used to connect the 02R to a MIDI time code source for external synchronization.
- 12. STEREO OUT DIGITAL connectors**
The COAXIAL output is an RCA/phono jack. It outputs the main stereo signals for recording, and can be connected to DAT, MD, and DCC digital recorders via a 75Ω coaxial cable. The output format is IEC958 Part 2 (S/PDIF - Consumer).
- The AES/EBU output is an XLR-3-32 type connector. It also outputs the main stereo signals for recording. The output format is IEC958 Part 3 (AES/EBU - Professional).
- 13. MIDI connectors**
These are standard 5-pin DIN-type MIDI THRU, OUT, and IN connections. They are used to connect the 02R to external MIDI devices for sequencer synchronization and control.
- 14. WORD CLOCK connectors**
These are TTL/ 75Ω BNC connectors for transmitting (OUT) and receiving (IN) word clock signals. A switch is provided to apply a 75Ω terminator to the signal if the 02R is the last device in the chain.
- 15. TO HOST connector**
This 8-pin MiniDIN connector is to plug a Macintosh or PC into the 02R for dedicated external system control.
- 16. 2TR IN DIGITAL (1 to 3) connectors**
2TR IN DIGITAL (1) is an XLR-3-32 type connector. The input format is IEC958 Part 3 (AES/EBU - Professional).
- 2TR IN DIGITAL (2 and 3) are RCA/phono jacks. The input format is IEC958 Part 2 (S/PDIF - Consumer).
-

Signals input here are fed through to the CONTROL ROOM buttons (24) and are monitored in the control room or the studio. The outputs of a 2-track master recorder can be connected here for confidence monitoring and playback.

Note: *Digital signals routed through the control room selector switch do not have to be synchronized with the system word clock.*

The signals from 2TR IN DIGITAL (1) can also be routed to stereo input channels 17/18.

The signals from 2TR IN DIGITAL (2) can be routed to stereo input channels 19/20 or directly to the stereo buss.

Note: *Digital signals that are routed to the stereo input channels or directly to the stereo buss must be synchronized with the system word clock to prevent dropout and/or other noise.*

17. Option slots (1 to 4)

These slots accept one of the optional I/O cards.

List of Cards

Card	Format	Product	Size	Slot
Digital I/O	AES/EBU	CD8-AE	Double	1 or 2 (max 2 cards - 16 ch)
		CD8-AE-S	Single	1 ~ 4 (max 4 cards - 32 ch)
	ADAT	CD8-AT	Single	1 ~ 4 (max 4 cards - 32 ch)
	TDIF-1	CD8-TDII	Single	1 ~ 4 (max 4 cards - 32 ch)
	YAMAHA	CD8-Y	Single	1 ~ 4 (max 4 cards - 32 ch)
Analog I/O	AD/DA	CD8-AD	Double	1 or 2 (max 2 cards - 16 ch)
Cascade Kit		CD8-CS KIT	Single × 2	Any (normally 3 or 4)

Use slots 1 and 2 for direct output lines to your multi-track recorder. See Section 13, "Installing Options" on page 171 of the *User's Guide* for further details.

Block Diagram

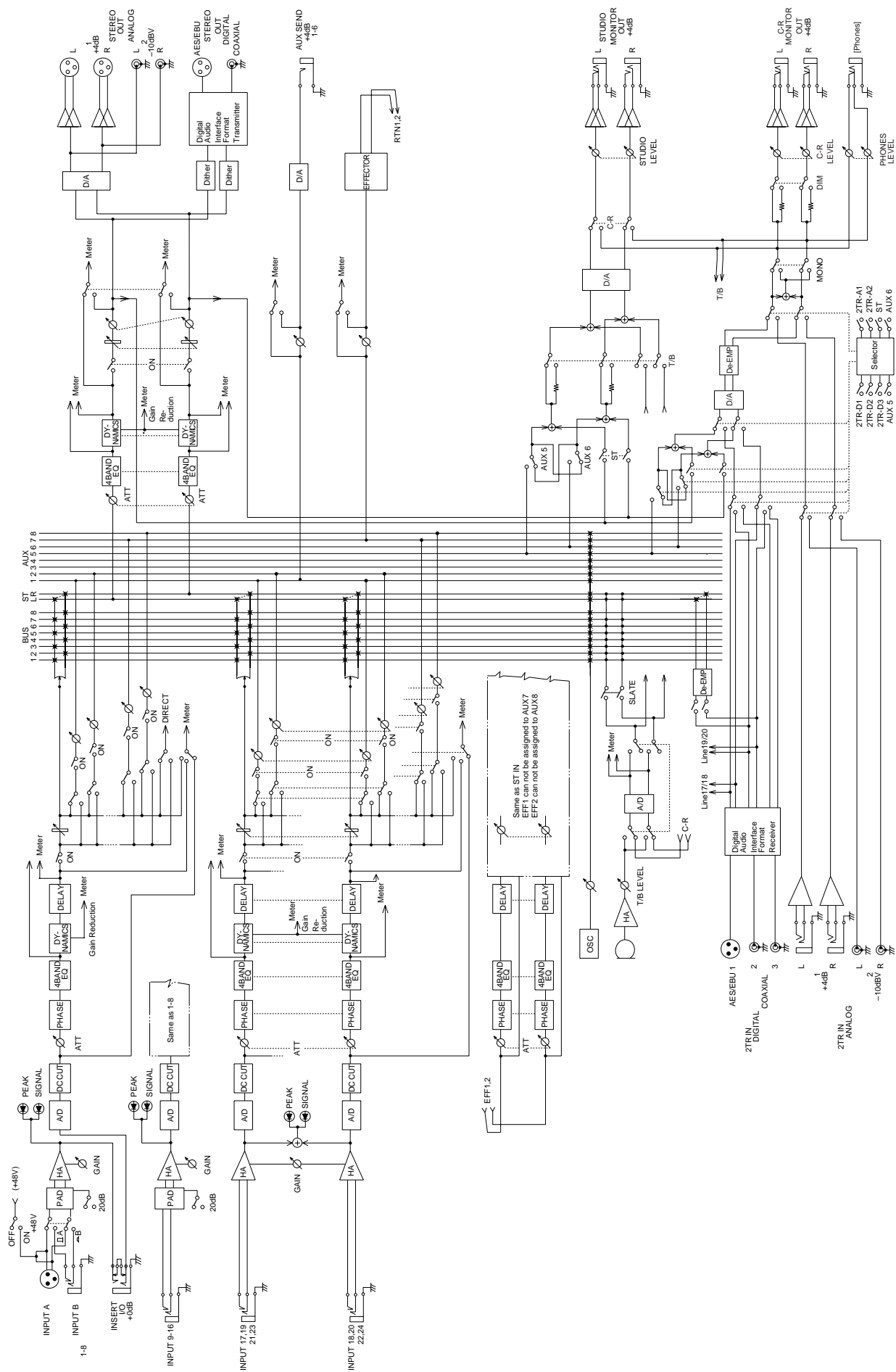

2

User Interface

In this chapter...

About the User Interface	18
DISPLAY ACCESS Buttons	18
Display	20
CURSOR Buttons	20
Encoder Wheel	21
ENTER Button	21
SCENE MEMORY Buttons	21
Display Functions	22
SELECTED CHANNEL Controls	23

About the User Interface

Digital Recording Console 02R user interface is powerful but very intuitive. There are two main methods of working with the 02R:

- Use the DISPLAY ACCESS controls to modify one parameter at a time across the entire recording console.
- Use the SELECTED CHANNEL controls to modify all of the parameters of the currently selected channel. You will find these controls similar to the setup of an analog mixer.

Use whichever method is most convenient to you. You will probably find you use a combination of both methods, dependent on what you are trying to do with the 02R.

The DISPLAY ACCESS controls consist of a block of twelve function buttons divided into three groups: the CONFIGURATION group, the MIXING group, and the AUX group, plus the large backlit graphical display screen, four CURSOR buttons, a detented encoder wheel, and the [ENTER] button. There is also a related block of four SCENE MEMORY buttons.

The SELECTED CHANNEL controls consist of four main blocks of controls, each block corresponding to the equivalent controls on an analog mixer. The ROUTING block selects the buss onto which to route the current channel signal. The AUX block selects the auxiliary buss to send the channel signal to and sets the send level. The PAN block sets the pan position of the channel signal. The EQ block sets the equalization curve for the current channel.

The biggest difference between the two methods is that the DISPLAY ACCESS functions are directly associated with one or more displays on the display screen. The following section will briefly explain each of the controls of the two main blocks. Later sections will give more details about how to use these controls.

DISPLAY ACCESS Buttons

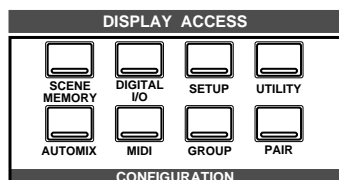

CONFIGURATION group

These buttons access the Display Functions that control the system configuration of the 02R.

- The [SCENE MEMORY] button is used to examine and edit the scene memories. You can also set channels to “recall safe”, which means they will not change levels when the scene is recalled, and you can set recall fade time.

- The [DIGITAL I/O] button is used to select the word clock source, define the digital input/output connectors, control the cascade configuration, and set the word dither.
- The [SETUP] button is used to control the solo function and defines system preferences.
- The [UTILITY] button is used to set the oscillator function and check the battery, emphasis, and channel status monitors.
- The [AUTOMIX] button is used to set and control the automation parameters.
- The [MIDI] button is used to select the MIDI channels and MIDI functions.
- The [GROUP] and [PAIR] buttons are used to create fader and mute groups and pair faders together.

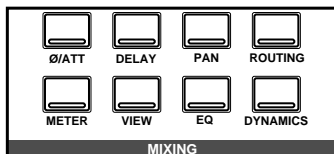

MIXING group

These buttons access the Display Functions that set mixer parameters for the entire recording console.

- The [Ø/ATT] button is used to invert the phase and attenuate the signals after they have been converted to digital.
- The [DELAY] key is used to apply a small delay to the input signal, for example, to compensate for the gap between the record and playback heads of your multitrack recorder.
- The [PAN] button is used to adjust the pan position for a group of channels.
- The [ROUTING] button selects the routing page – a large visual patch bay.
- The [METER] button is used to meter the individual channels.
- The [VIEW] button is used to adjust all the parameters for the selected channel. It also accesses the Channel library.
- The [EQ] button is used to view the equalization curve and parameters of each individual channel. It also accesses the EQ library.
- The [DYNAMICS] button is used to adjust the dynamics of each individual channel. It also accesses the Dynamics library.

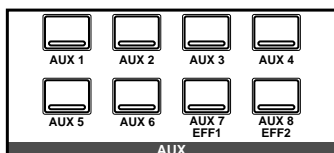

AUX group

These buttons access the Display Functions that set the auxiliary send levels for the recording console.

- The [AUX 1] to [AUX 6] buttons set the auxiliary send levels to the corresponding auxiliary buss. You can also select whether to send the signal pre or post fader.
- The [AUX 7] and [AUX 8] buttons also set the send levels to the corresponding auxiliary buss and can select pre or post fader.

However, these two sends are routed to the internal effects unit. Therefore, the buttons also allow you to select and set the effects parameters.

Display

The large backlit 320 × 240 pixel graphical display screen provides clear indication of mix settings and operating status. As well as showing parameter values numerically, faders and rotary controls are represented graphically, so you can actually see pan positions and fader positions. In addition, EQ curves are displayed graphically and signal levels are metered. The following illustration shows information that is always displayed and explains what it means:

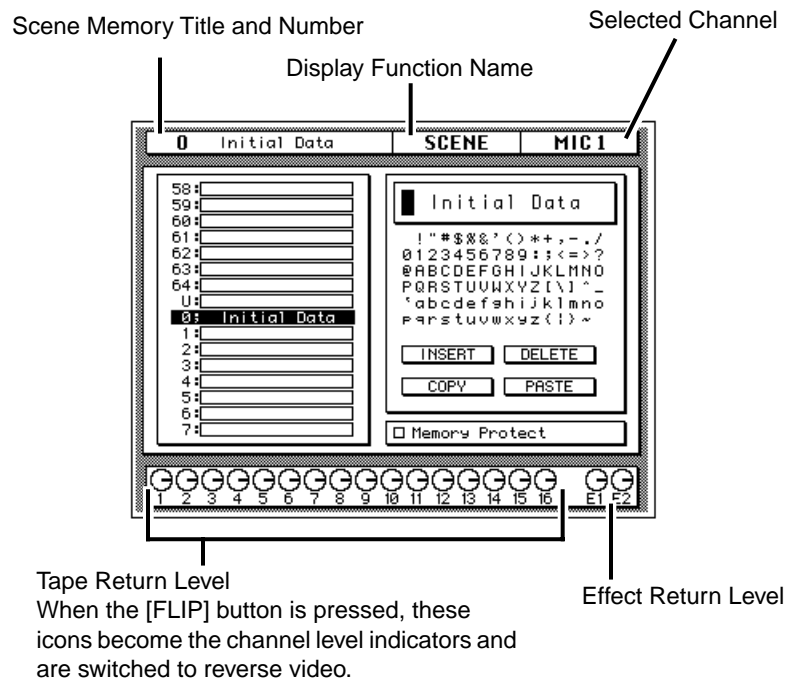

The CONTRAST control allows you to adjust the brightness of the screen for different environments.

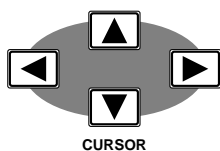

CURSOR Buttons

The CURSOR buttons are used to select parameters and options on the display screen. The selected parameter or option usually appears highlighted.

The CURSOR buttons are also used to position the cursor in a name when naming automation mixes, scene memories, equalizer programs, effects programs, dynamics programs, and channel library programs.

When a display left or right icon appears at the left or right side of the display, indicating that another display page is available, the CURSOR buttons are used to select that display.

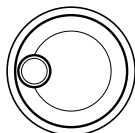

Encoder Wheel

The encoder wheel is used to adjust the parameter selected using the CURSOR buttons. Its detented action gives it a positive feel, allowing quick and accurate parameter adjustments. Turning it clockwise increases the selected parameter value. Turning it counterclockwise decreases the selected parameter value. The faster you turn it, the faster the parameter value changes.

The encoder wheel is also used to scroll through the automation programs, mix scenes, effects programs, EQ programs, and dynamics processor programs. When naming automation programs, mix scenes, user effects programs, user EQ programs, and user dynamics programs, the encoder wheel is used to scroll through the available characters.



ENTER Button

The [ENTER] button is used to confirm settings made using the encoder wheel and to toggle two-option parameters such as EQ ON/OFF.

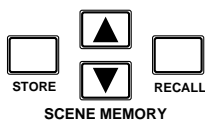

SCENE MEMORY Buttons

These buttons allow you to select, store and recall scene memories. The current scene memory is indicated on the SCENE MEMORY LED.

Display Functions

The following table lists all the Digital Recording Console 02R display functions and briefly explains what they do.

Display Function	Description
SCENE	Store and recall mix scenes.
DIGITAL I/O	Sets digital I/O parameters and selects word clock.
SETUP	Sets the solo parameters and system preferences.
UTILITY	Controls the oscillator parameters and accesses the emphasis monitor, the channel status monitor, and the battery level check.
MIDI	Set the MIDI channels, build the program change table, and control MIDI bulk data transfers.
AUTOMIX	Create, store, recall, and play automation programs.
GROUP	Set up the fader and mute groups.
PAIR	Set up channel pairs.
Ø/ATT	Set phase and attenuation.
DELAY	Set the channel delay.
PAN	Set the pan position.
ROUTING	Set the channel routing.
METER	Meter the levels from the individual input channels, the tape and effect return channels, the 8 main busses, and the 8 auxiliary busses.
VIEW	Set all parameters for the selected channel and access the channel library.
EQUALIZER	Set the equalization and access the EQ library.
DYNAMICS	Set the dynamics processor and access the dynamics library.
AUX 1 to 6	Set the channel levels to the auxiliary busses.
AUX 7 and 8	Set the channel levels to the auxiliary busses and set the internal effect parameters.

SELECTED CHANNEL Controls

These controls are very similar in setup to the controls of an analog mixer. You may find working with the buttons and controls of this section of the 02R is much faster and more intuitive than working through the screens of the DISPLAY ACCESS functions.

ROUTING buttons

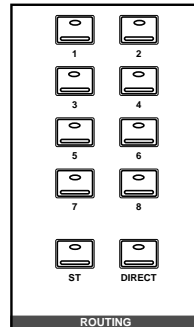

The routing buttons allow you to directly select the destination for the selected channel. The LEDs in the buttons illuminate to indicate the status of the channel.

Note: You can customize your 02R so that when you adjust any of the controls in this group, the display switches to the ROUTING display function. See “Preferences” on page 162 of the User’s Guide.

AUX controls

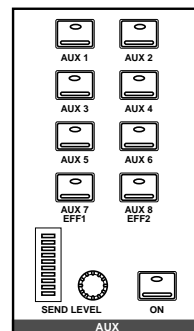

The AUX buttons allow you to select the auxiliary busses you want to send the selected channel signal to. The SEND LEVEL rotary encoder is used to set the level – indicated by the adjacent LED bargraph. The [ON] button is used to turn the send on or off. This allows you to make quick A-B comparisons.

PAN controls

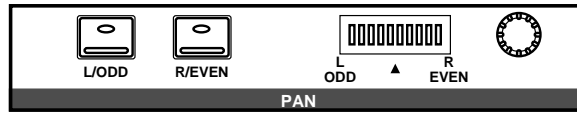

These controls allow you to select the pan position of the selected channel. The buttons select one of two channels (channels are always paired for the pan function). Use the rotary encoder to adjust the pan position. The current position is indicated on the adjacent LED bargraph.

Note: You can customize your 02R so that when you adjust any of the controls in this group, the display switches to the PAN display function. See “Preferences” on page 162 of the User’s Guide.

EQUALIZER controls

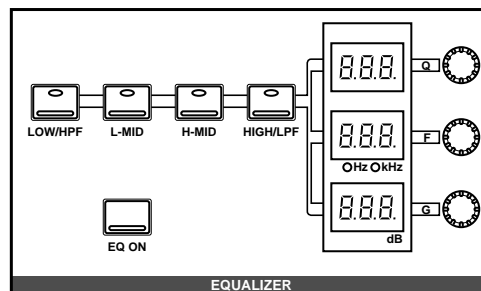

These controls allow you to adjust the equalization of the selected channel. Select the band you want to adjust with one the buttons in the top row: [LOW/HPF], [L-MID], [H-MID], or [HIGH/LPF]. The three LED indicators will reflect the status of the selected band. Adjust the values (Q, F, and G) with the adjacent rotary encoders. Use the [EQ ON] button to insert the equalization into the channel.

Note: You can customize your 02R so that when you adjust any of the controls in this group, the display switches to the EQUALIZER display function. See “Preferences” on page 162 of the User’s Guide.

3

Mixing and Monitoring

In this chapter...

Analog Inputs.....	26
Phantom Power.....	26
Pad.....	27
GAIN Controls.....	27
SEL Buttons.....	27
ON Buttons.....	28
Faders.....	28
Analog Outputs.....	29
Monitor Selector Switches.....	29
Monitor Level Controls.....	30

Analog Inputs

The Digital Recording Console 02R is equipped with 24 individual analog input connectors. The first sixteen channels, 1 through 16, are monophonic input channels designed for microphone to line level signal inputs. The last eight channels, 17 through 24, are stereo pairs designed for line level signals only.

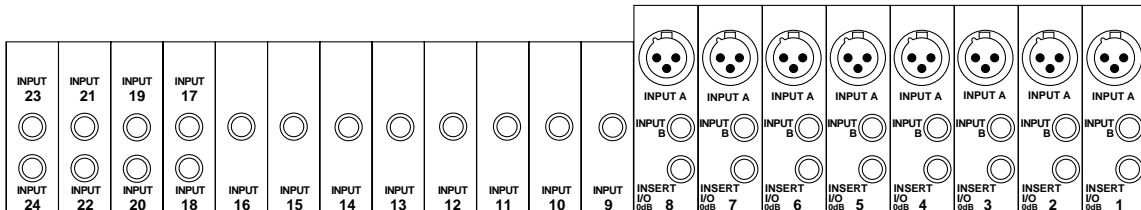

In addition, the first eight channels not only have selectable input connectors, XLR-type or phone, but they also have an insert connector, allowing you to patch external signal processors before the input signal is converted to digital.

For monitoring the output of a stereo tape recorder or another similar analog device, the 02R also has two pairs of 2TR IN phone connectors.

Phantom Power



Phantom power provides a +48 V DC power source for condenser type microphones. It is applied to the XLR-type connectors (INPUT A) for input channels 1 through 8. The phantom power switch for each channel is used to turn it ON and OFF. Phantom power is applied to each individual input.



Phantom power can only be applied to the XLR-type connectors (INPUT A) for input channels 1 through 8. Select those connectors with the A/B switch: up for A, down for B.

With phantom power set to ON, non-phantom powered microphones, dynamic microphones, and balanced line-level sources can still be connected to INPUT A connectors for input channels 1 through 8. However, be careful with unbalanced sources.

Pad



The Pad function attenuates input signals by 20 dB. This is useful when inputting high level signals that would otherwise overload the input preamplifier. By increasing the effective range of the GAIN control, high-level signals can be adjusted accurately. Pad can be set individually for the mono input channels 1 through 16. The [20dB] (pad) switch at the top of each channel is used to turn it ON and OFF: up for OFF, down for ON.

GAIN Controls

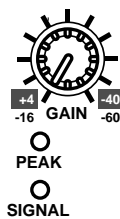

The GAIN controls are used to optimize the input channel signal levels. Use them with the PEAK indicators. This red LED illuminates when the input signal exceeds 3 dB below clipping. Ideally the level should be set relatively high. It is acceptable if this LED illuminates occasionally. If it is continuously illuminated, however, back off the GAIN control a little, otherwise the input preamplifier is being overloaded and clipping distortion will result.

The GAIN control should be set with some care. If it is set too low, the signal-to-noise performance will suffer, and if it is set too high, unpleasant signal clipping and distortion may occur.

The SIGNAL indicator is a green LED which illuminates when the input signal exceeds 10 dB below nominal.

The analog input controls are not controlled or stored by the 02R automation and scene memory functions. To assist in easy recall of the gain setting, the GAIN controls are detented. You should note the analog settings on a copy of the User Settings Sheet at the back of the manual.

SEL Buttons



The [SEL] buttons are used to select a channel in order to perform some action on it. When a channel is selected, the LED set in the corresponding button lights up and its name appears in the Selected Channel area of the display screen. Stereo-pair channels are selected together.

Note: You can use the [SEL] buttons to create stereo-pair channels. Refer to "Pairing Channels" on page 150 of the User's Guide.

The SELECTED CHANNEL controls are set to the current status of the selected channel. Depending on which display function is active, the selected channel may be highlighted, or the entire display may be dedicated to its parameters.

ON Buttons



The [ON] buttons are used to turn channels on and off. The input channel, tape return channel, effect return channel, and stereo output [ON] buttons turn their respective channels on and off. When a channel is turned on, the LED set in the corresponding button lights up. When it is turned off, the LED goes off. Stereo-pair channels are turned on and off together.

Faders

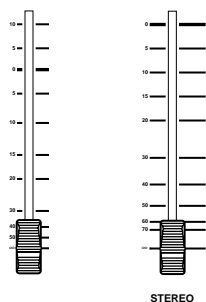

The 02R's faders are motorized. This means that they can be positioned automatically. You can group or pair faders together so all faders in a group or pair move automatically when you move any fader in that group or stereo pair.

Fader positions are stored in scene memories. When a scene memory is recalled the faders automatically move to their stored positions.

Fader positions are stored when the 02R is powered OFF. Even if faders are subsequently moved, they return automatically to their last positions when the 02R is powered ON again.

Note: You should avoid placing objects on the 02R that may block fader movements. There are several operations, such as recalling a scene memory, selecting the auxiliary buses, and automation playback, that automatically move the faders. If a fader is blocked, it could be damaged as it attempts to move.

Rotary Encoders



To adjust the levels of the tape and effect return channels, the 02R provides a continuously rotary encoder for each channel. The channel levels are indicated by the Tape Return Level and Effect Return Level icons on the bottom of the display screen.

FLIP Button



Although the rotary encoders are reasonably accurate, there will be times, for example during a mixdown, when you want the increased accuracy and feel of a fader to adjust the tape return levels.

The faders for input channels 1 through 16 are multi-function controls. When you press the [FLIP] button, the faders switch to adjusting the tape returns. The Tape Return icons change to reverse video to indicate the input channels have moved up to the TAPE controls, and the LED in the [FLIP] button is illuminated.

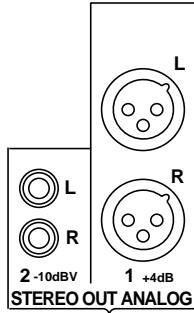

Analog Outputs

The Digital Recording Console 02R is equipped with a pair of analog stereo out connectors, one pair XLR-type for connecting to professional equipment, the other phono (RCA) jacks. There are also two pairs of phone jacks to provide a stereo output to your control room and studio monitoring systems.

Monitor Selector Switches

STUDIO Buttons

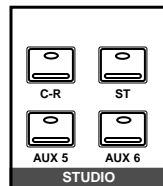

These buttons select the monitor signal sent to the studio monitor system. In many studios, this would be a headphone amplifier, typically one that could drive several sets of headphones. This system provides the monitoring that your musicians need in order to successfully work on a multitrack recording.

You can select the same signal that is being monitored in the control room with the [C-R] button. When you press this button, it cancels the current settings. When you press it again, it restores the previous settings.

You can send the signal from the stereo bus by pressing the [ST] button. The most flexible approach is to set up a separate mix using one of the auxiliary channels (press either the [AUX5] or [AUX6] button), and send that to the studio monitors. This allows you, for example, to apply reverb and equalization to the monitor signal you send to your vocalist, while you record the performance dry. You can select any combination of the [ST], [AUX5], and [AUX6] buttons – including none.

CONTROL ROOM Buttons

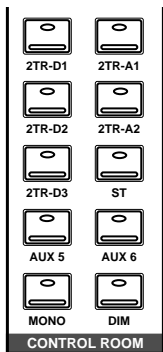

The buttons select the monitor signal sent to the control room monitor system. This is usually a large pair of near-field loudspeakers. Many studios also use a smaller speaker system, such as the YAMAHA NS-10M, to monitor a “typical” listening environment.

You can select one of five 2TR IN inputs, three of which are digital (the 2TR-D1 to 2TR-D3 buttons). These inputs are used for monitoring two track source signals, for example, the return of your master recorder. When you press any of these buttons, the current setting is cancelled. When you press the button again, the previous setting is restored.

You can also monitor the signal on the stereo bus with the [ST] button or select the auxiliary channels (AUX5 or AUX6). You can select any combination of the [ST], [AUX5], and [AUX6] buttons – including none.

Convert the monitor signal to monaural by pressing the [MONO] button or mute the output by 20 dB by pressing the [DIM] button.

SOLO Button



You can monitor input channels in isolation by pressing the [SOLO] button. The LEDs in the centre of the selected channel [ON] buttons are extinguished. You select the channel(s) you want to solo by pressing the corresponding [ON] button. When you press the [SOLO] button again, the originally selected LEDs are illuminated again.

Note: *If the 02R is connected to other units with the digital cascade kit (CD8-CS), only the [SOLO] button on the cascade master unit is valid. See “Digital Cascade Kit (CD8-CS)” on page 183 of the User’s Guide*

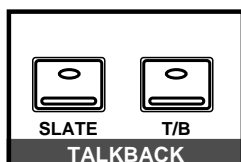

TALKBACK Buttons

The talkback system allows you to talk to musicians in the studio without leaving the Digital Recording Console 02R. Press the [T/B] button and start talking. The [SLATE] button sends the talkback signal to the main buses as well as the stereo bus, for example, allowing you to record a memo before recording a take.

You can also record 100 Hz, 1 kHz, and 10 kHz sine waves and white noise tones by using the oscillator function. See “Oscillator” on page 165 of the *User’s Guide* for details.

Monitor Level Controls



C-R LEVEL Control

This control is used to adjust the volume output through the control room monitor outputs.



T/B LEVEL Control

This control adjusts the volume of the talkback signal. The talkback signal is picked up by the built-in microphone right below the control.



STUDIO LEVEL Control

This control is used to adjust the overall volume output through the studio monitor outputs.

If you are using a headphone amplifier to provide studio monitoring, you may need a unit that allows individual adjustment of each set of headphones.

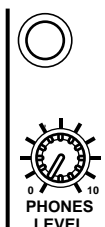

PHONES LEVEL Control

This control is used to adjust the volume of a set of stereo headphones plugged into the connector just above the control.

4

MIXING Display Functions

In this chapter...

Phase and Attenuation	32
Delay	34
Pan and Balance	36
Stereo-Pair Pans	37
Stereo Width	37
PAN controls	38
Routing	39
ROUTING buttons	40
Metering	41
View	44
Channel Library	47
Equalizer	49
EQUALIZER controls	51
Equalizer Programs	52
Equalizer Library	53
Preset EQ Program Parameters	56

Phase and Attenuation

1. Press the (Ø/ATT) button.



The Ø/ATT display function appears.

2. Select a channel using the (SEL) buttons or the CURSOR buttons.
3. To change the phase, press the (ENTER) button. The NOR icon changes to REV and is highlighted in reverse video when the phase is inverted.
4. To change the attenuation, rotate the encoder wheel until the desired value is shown.

Note: Double-click the [ENTER] button to set all the channels phase and attenuation to the same level as the selected channel. The STEREO channel is not affected.

5. Select another channel by pressing the (SEL) buttons of the CURSOR buttons.

Phase

The Phase (Ø) function inverts the phase of the selected signal. When the phase of an channel is inverted against a corresponding channel, it can cause attenuation of both channels due to phase-cancellation. This can be caused by incorrectly wired cables or connectors. It can also be caused improper microphone placement, especially when attempting to record in stereo.

The Phase (Ø) function can compensate for these problems. It is also useful, for example, when a snare drum is miked top and bottom. In this case the bottom microphone signal should be phase inverted. The phase can be set to normal or reverse (inverted) for the input channels and the tape and effect returns.

The stereo input channels are always ganged together. The MIC/LINE and TAPE channels are always set independently even when they have been linked together in GANG mode with the PAN function.

Note: You cannot invert the phase of the STEREO output channel.

Attenuation

The Attenuation function is used to cut the level of the selected signal by as much as 96 dB. This attenuation is applied after the signal has been converted to digital (or format converted in the case of a digital input).

Note: The STEREO output channel attenuation is in the range of +12 dB to -96 dB. The attenuation for all other channels is 0 dB to -96 dB.

The attenuation function is repeated in the EQUALIZER display functions, where it can be used to compensate for the gain increases caused by boosting different frequencies.

You can also set the phase and attenuation with the VIEW display function.

Display Screens

There are two screens in the Ø/ATT display function. Shown below is the first – MIC/LINE 1 through 16 and LINE 17/18 through 23/24:

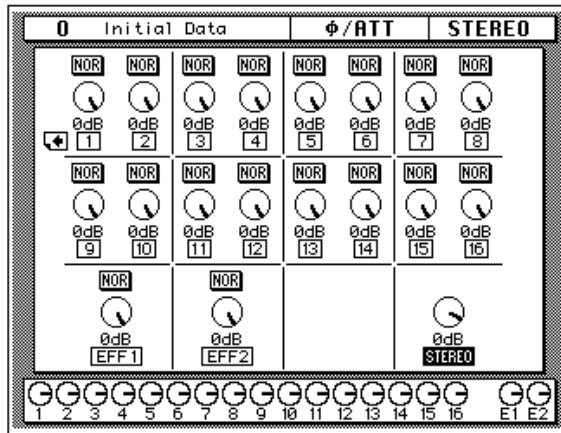

Select this screen by pressing a [SEL] button for one of the MIC/LINE channels.

Shown below is the second screen – TAPE 1 through 16, EFF1 and EFF2, and STEREO output (attenuation only):

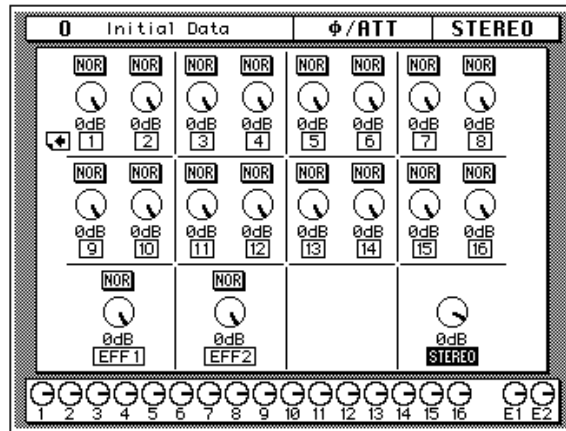

Select this screen by pressing a [SEL] button for the tape or effect returns channels or the master stereo output channel.

Delay

1. Press the (DELAY) button.



The DELAY display function appears.

2. Select a channel using the (SEL) buttons or the CURSOR buttons.
3. By default, the delay is off. Press the (ENTER) button to turn it on. The OFF icon, highlighted in reverse video, changes to ON.
4. Use the CURSOR buttons to select either (Smpl) or (mSEC).
5. To change the delay, rotate the encoder wheel until the desired value is shown.

Note: Double-click the [ENTER] button to set the delay for all channels to the same value as the selected channel.

Rotate the encoder clockwise to increase the delay amount and counter-clockwise to decrease the delay amount.

The DELAY display function is used to apply a small amount of delay to input or return signals to compensate for situations such as line or cabling delays or the gap between the record and playback heads (or circuitry) of your multitrack recorder. You can delay a signal from 0 to 2,600 samples – at 44.1 kHz this is a delay of 0 to 59.0 ms and at 48 kHz it is a delay of 0 to 54.2 ms.

Delay can be applied to any of the input channels and the tape and effect return channels. The stereo input channels are always ganged together. The MIC/LINE and TAPE channels are set independently only when they are not linked together in GANG mode with the PAN function

Delay and Cascade

If you use a digital cascade kit (CD8-CS) to connect more than four 02Rs together, you will need to use the DELAY display function to apply delay to the machines closest to the output. Set a delay value of 10 to 20 samples for each unit.

The digital cascade kit will automatically apply the correct amount of delay when you connect four or less 02Rs together. See “Cascade Configuration” on page 157 of the *User’s Guide*.

Display Screens

The following illustration shows the first screen of the DELAY display function. It shows the MIC/LINE 1 through 16 and LINE 17/18 through 23/24:

0 Initial Data		DELAY	MIC 1
Smpl mSEC	Smpl mSEC	Smpl mSEC	
1 0 0.0 ON	9 0 0.0 ON	17 0 0.0 ON	
2 0 0.0 ON	10 0 0.0 ON	18	
3 0 0.0 ON	11 0 0.0 ON	19 0 0.0 ON	
4 0 0.0 ON	12 0 0.0 ON	20	
5 0 0.0 ON	13 0 0.0 ON	21 0 0.0 ON	
6 0 0.0 ON	14 0 0.0 ON	22	
7 0 0.0 ON	15 0 0.0 ON	23 0 0.0 ON	
8 0 0.0 ON	16 0 0.0 ON	24	

Select this screen by pressing a [SEL] button for one of the MIC/LINE channels.

The following illustration shows the second screen – TAPE 1 through 16 and the effect returns, EFF1 and EFF2:

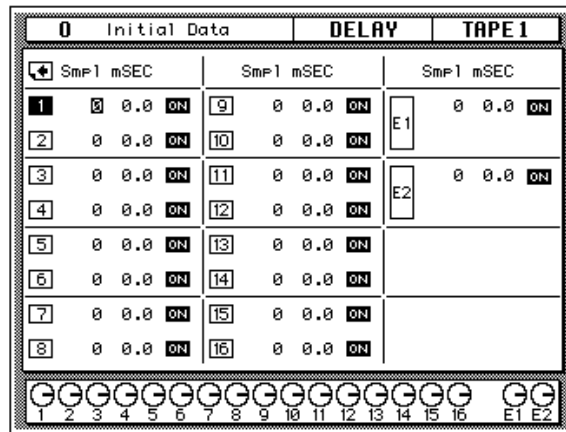

Select this screen by pressing a [SEL] button for the tape or effect returns channels.

Fine-Tuning the Delay

You can adjust the delay, either samples [Smp] or milliseconds [mSEC] with coarse or fine precision just by the placement of the cursor on the selected channel.

For example, if the cursor is positioned over the thousands digit of the samples [Smp] field, when you rotate the encoder wheel, the values increase or decrease by thousands of samples.

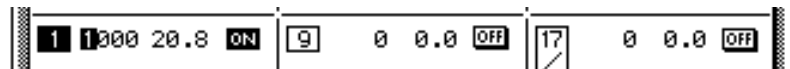

If the cursor is positioned over the hundreds or tens digit of the samples field, when you rotate the encoder wheel, the values increase or decrease by hundreds or tens of samples.

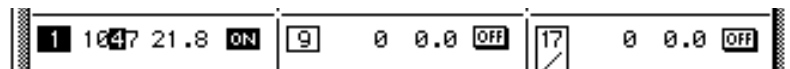

The same is true when the cursor is positioned over the ones digit of the samples field, or the tens, ones, or decimal digits of the milliseconds [mSEC] field.

Pan and Balance

1. Press the (PAN) button.



The PAN display function appears.

2. Select a channel using the (SEL) buttons or the CURSOR buttons.
3. To change the pan position, rotate the encoder wheel until the desired value is shown.

The PAN display function is used to pan and balance signals. The input channels, including the stereo input channels, and the tape and effect returns can be panned, and the stereo output can be balanced.

Display Screens

Shown below is the first screen of the PAN display function – MIC/LINE 1 through 16 and LINE 17/18 through 23/24:

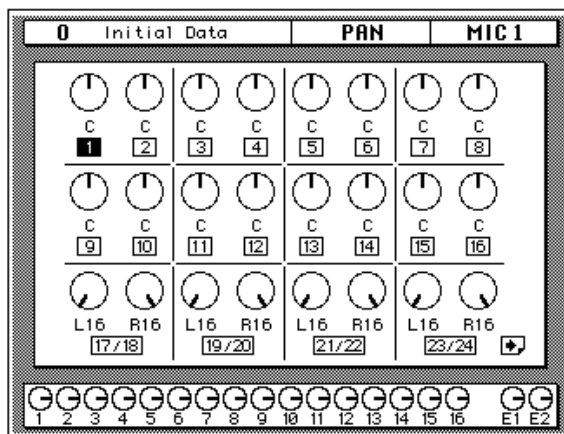

Select this screen by pressing a [SEL] button for one of the MIC/LINE channels.

Shown below is the second screen – TAPE 1 through 16, EFF1 and EFF2, and STEREO output (balance):

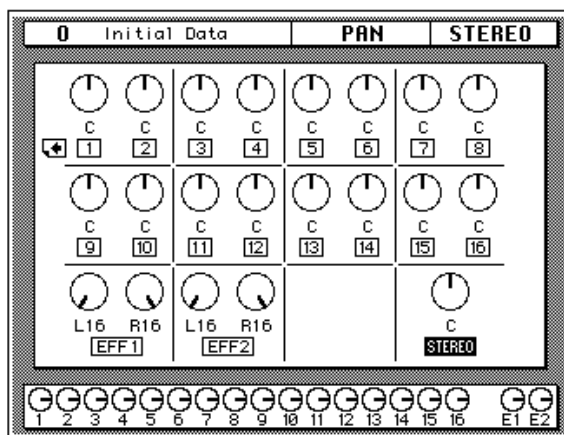

Select this screen by pressing a [SEL] button for the tape or effect return channels or the master stereo output.

The number of the selected channel is highlighted. Channel pan positions are indicated by marker lines, just like the ones on real knobs. The current pan value is displayed under the panpot icon.

Pan Positions

Including center, there are 33 pan positions:

L16 ← L15 ← ... ← L2 ← L1 ← C → R1 → R2 → ... → R15 → R16

Stereo-Pair Pans

Odd and even pairs of channels can be linked together in GANG mode providing simultaneous pan adjustment. This function can be set by pressing [ENTER] when one of a pair of channels is selected. The GANG is indicated by a pair of dotted lines linking the top and bottom of the pan control icons as shown in the following illustration:

1. Press the (PAN) button.



2. Select a channel using the (SEL) buttons or the CURSOR buttons.
3. Press the (ENTER) button to connect the odd and even channels together.

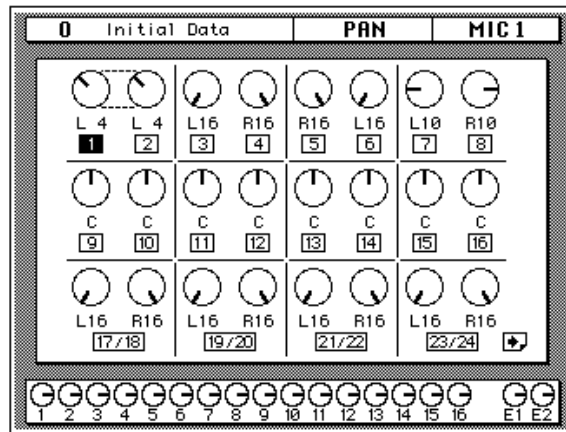

To set the channels back to INDIVIDUAL mode, just press the [ENTER] button again. The dotted lines between the pan control icons are deleted.

Stereo Width

In INDIVIDUAL mode, the width of a stereo signal can be set. When the pan controls are set hard-left and hard-right, the stereo width is 100%. With both pans set to center the stereo width is 0%. Setting the controls to a position in between allows you to set the stereo width from 0% to 100%. To maintain a central balance, however, you must set both controls to a corresponding left and right values. For example, L5 and R5, or L10 and R10.

Switching to GANG mode allows you to reposition the stereo signal within the stereo field. For example, you could set L5 and R10 before you GANG the channels. After you press [ENTER], adjusting either channel moves the other a corresponding amount. If you set the left channel to L7, the right channel would adjust to R8.

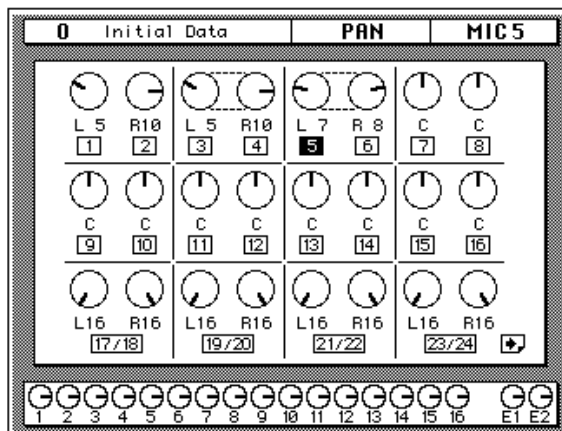

PAN controls

You can also adjust the pan position or balance of the selected channel with the controls in the SELECTED CHANNEL group.

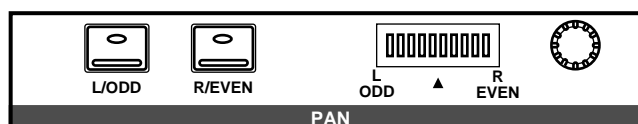

These controls allow you to select the pan position of the selected channel. The buttons select one of two channels (channels are always paired for the pan function). The LED is illuminated in the selected channel of the pair.

Use the rotary encoder to adjust the pan position. The current position is indicated on the adjacent LED bargraph.

You can link the odd and even channel pairs by pressing and holding the [L/ODD] button and then pressing the [R/EVEN] button. When a pair of channels are linked together in GANG mode, The LEDs in both buttons are illuminated and the LED of selected channel flashes. The indicator for the selected channel also flashes in the adjacent LED bargraph.

Note: You can customize your O2R so that when you adjust any of the controls in this group, the display switches to the PAN display function. See "Preferences" on page 162 of the User's Guide.

Routing

1. Press the (ROUTING) button.



The ROUTING display function appears.

2. Select a channel using the (SEL) buttons or the CURSOR buttons.
3. Use the CURSOR buttons to select the routing destinations and press the (ENTER) button to switch a route ON or OFF.

The ROUTING display function is used to select the bus routing of the input channels and tape and effect return signals. The first sixteen input channels, 1 through 16, can also be routed to the direct outputs.

By default, all channels are routed to the stereo bus.

Direct Outputs

All the input channels and tape and effect return signals can be routed to the output buses and the stereo bus. You can only route the first sixteen input channels, MIC/LINE 1 through 16, to the direct outputs.

The outputs for the optional boards are as follows:

Slot	Direct Out all OFF	Direct Out all ON
Slot 1	Bus 1 to 8	Direct 1 to 8
Slot 2	Bus 1 to 8	Direct 9 to 16
Slot 3	Bus 1 to 8	Bus 1 to 8
Slot 4	Bus 1 to 8	Bus 1 to 8

If you select both direct out and an output bus for a channel, the direct output will take priority.

Display Screens

Shown below is the first page of the ROUTING display function – MIC/LINE 1 through 16 and LINE 17/18 through 23/24:

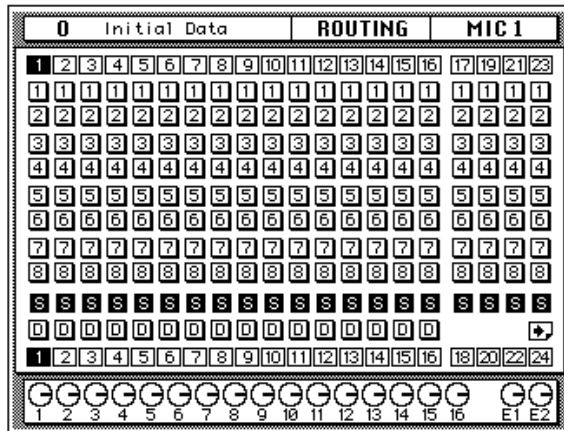

Select this screen by pressing a [SEL] button for one of the MIC/LINE channels.

Shown below is the second screen – TAPE 1 through 16, EFF1 and EFF2, and STEREO output (balance):

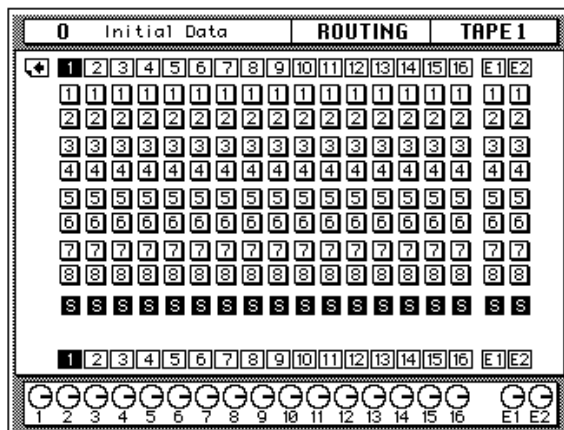

Select this screen by pressing a [SEL] button for the tape or effect returns channels or the master stereo output.

ROUTING buttons

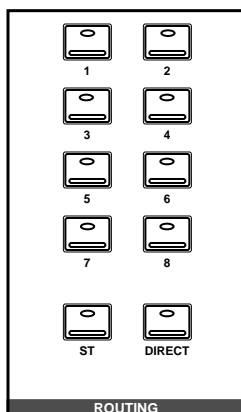

You can also adjust the routing for the selected channel with the ROUTING buttons in the SELECTED CHANNEL group. A route is selected ON when its icon is highlighted on the display in reverse video.

The routing buttons allow you to directly select the destination for the selected channel. The LED inset each the button illuminates to indicate the status of the channel.

Note: You can customize your O2R so that when you adjust any of the buttons in this group, the display switches to the ROUTING display function. See "Preferences" on page 162 of the User's Guide.

Metering

1. Press the (METER) button.



The METER display function appears.

To select the first screen, press the (METER) button. Subsequent presses of the (METER) button select the next two screens in sequence.

2. Select a channel using the (SEL) buttons or the CURSOR buttons.
3. Use the CURSOR buttons to select the PEAK HOLD icon and press the (ENTER) button to switch the function on or off.
4. Select one of the meter source point icons – PRE EQ, POST EQ, or POST FADER – with the CURSOR buttons. Make it the current meter point by pressing the (ENTER) button.

The Digital Recording Console 02R features comprehensive signal level metering. The mono and stereo input channels, the tape and effect returns, and the auxiliary sends and buses are all metered using the METER display function. The control room output is metered using the dedicated 21-segment LED meters. Peak hold is available for all meters.

Display Screens

The METER display function consists of three screens. The first screen shows the input channels – MIC/LINE 1 through 16 and LINE 17/18 through 23/24:

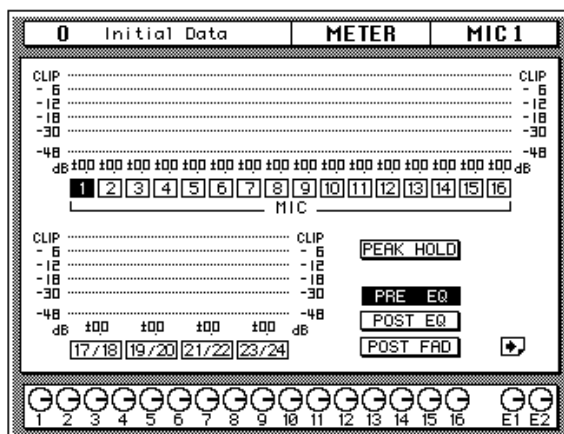

Select this screen by pressing a [SEL] button for one of the MIC/LINE channels.

The second screen shows the tape and effect returns – TAPE 1 through 16 and EFF1 and EFF2:

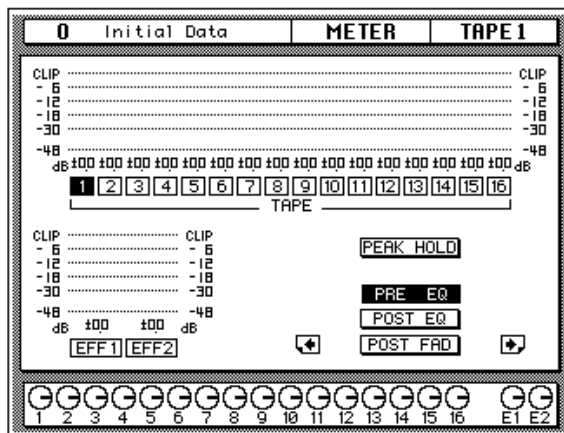

Select this screen by pressing a [SEL] button for the tape or effect returns channels. You can also select this screen by pressing the [METER] button until it appears in sequence.

Setting the Bus Levels

1. Use the CURSOR buttons to select one of the bus fader icons.
2. Adjust the level of the bus by rotating the encoder wheel.

The third screen shows the output and auxiliary buses and the stereo output, plus level faders for the buses:

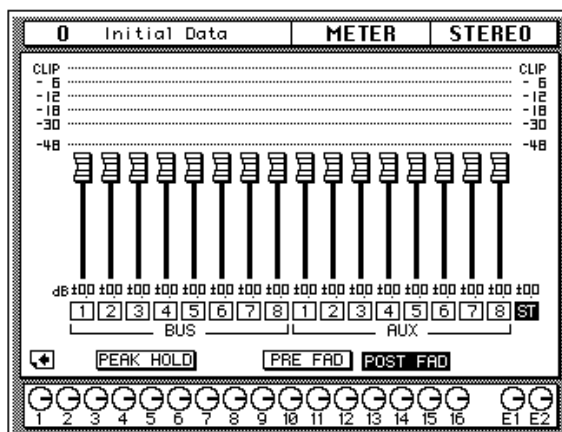

Select this screen by pressing the [SEL] button for the stereo output. You can also select this screen by pressing the [METER] button until it appears in sequence.

Peak Hold

The Peak Hold function can be turned on and off from any screen of the METER display function. Clear the peak hold levels by turning the Peak Hold off (select the PEAK HOLD icon and press the [ENTER] button) or by selecting another display function. The dedicated control room output meter peak hold is not affected when other display functions are selected.

Note: When the 02R reaches CLIP, digital signal distortion occurs. You must ensure this does not happen. Digital distortion is very unpleasant sounding. There are a several things you can do. If CLIP is reached, but the corresponding PEAK indicator is not illuminated, you need to attenuate the channel slightly with the \emptyset /ATT display function (see "Phase and Attenuation" on page 32 of the User's Guide). Otherwise, back off the GAIN control a little (see "GAIN Controls" on page 27 of the User's Guide).

Meter Source Points

The following table lists the meter signal source points:

Signal	Source Points		
MIC/LINE 1~24	Post GAIN and A/D, Pre EQ	Post EQ	Post Fader
TAPE 1~16, EFF1, EFF2	Pre EQ	Post EQ	Post Fader
BUS 1~8, AUX 1~8, STEREO OUT	Pre Fader		Post Fader

By changing the meter source points, you can easily observe the effect of changing the EQ or channel fader levels on the signal.

Note: *Switching the meter source point for the input channels switches it for the tape and effect returns as well. Switching it for the tape and effect return changes the input channels.*

Optional Meter Bridge – MB02

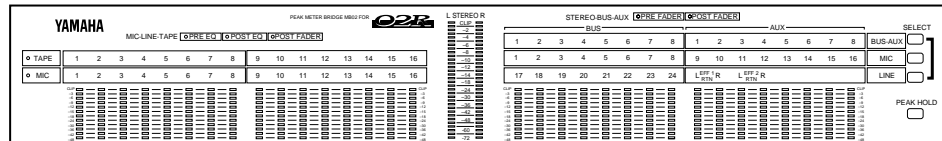

If your Digital Recording Console 02R is equipped with the optional Meter Bridge – MB02, the METER display function controls both the selection of the meter points for each channel as well as switching the Peak Hold function ON or OFF. The levels displayed on the optional meter bridge will be identical to the levels shown on the display screen when the METER display function is selected.

View

1. Press the (VIEW) button.



The VIEW display function appears.

2. Select a channel by pressing one of the (SEL) buttons.
3. Use the CURSOR buttons to select an item.
4. Adjust the value of the item using the encoder wheel and/or the (ENTER) button.
5. To set the EQ, use the CURSOR buttons to select the EQ curve and press the (ENTER) button. The 02R will switch to the EQUALIZER display function.
6. To set the dynamics, select the dynamics curve with the CURSOR buttons and press the (ENTER) button. The 02R will switch to the DYNAMICS display function.

The VIEW display function allows you to see all the parameters of an individual channel at a glance and adjust any parameter that you feel requires a change. You can view the input channels (MIC/LINE 1 through 16, LINE 17/18 through 23/24) and the tape and effect return channels (TAPE 1 through 16, EFF1 and EFF2).

Display Screen

Shown below is the VIEW display function:

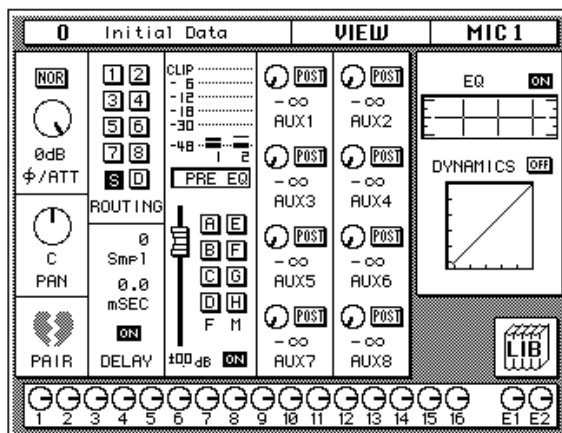

Unlike the previous display functions in this section, the VIEW display function shows the currently selected channel only.

Phase/Attenuation

Each time you press the [ENTER] button, the phase will alternate between NOR (normal) and REV (inverted). Rotate the encoder wheel to adjust the attenuation.

These controls duplicate the phase/attenuation function. See "Phase and Attenuation" on page 32 of the *User's Guide*.

Pan

Rotate the encoder wheel to set the pan position. You may find the PAN controls in the SELECTED CHANNEL group more convenient for setting the pan position.

When you press the [ENTER] button, the channel will be linked with its adjacent channel in GANG mode. Dotted lines will indicate the connection to the corresponding channel. Press the [ENTER] button again to switch back to INDIVIDUAL mode.

See "Pan and Balance" on page 36 and "Stereo-Pair Pans" on page 37 of the *User's Guide*.

Pair

Each time you press the [ENTER] button, PAIR will alternately be set or cancelled. Pair only applies to the individual input and tape return channels. See “Pairing Channels” on page 150 of the *User’s Guide*.

If the selected channel is one of the stereo input channels or the effect return channels, the PAIR function does not apply. Instead the pan control icon for the opposite channel will be displayed here.

Routing

Use the CURSOR buttons to select the routing assignment. Each time you press the [ENTER] button, the selected route will alternately switch on or off. You may find using the ROUTING buttons in the SELECTED CHANNEL group a more convenient way to select the routes. See “Routing” on page 39 of the *User’s Guide*.

Delay

Rotate the encoder wheel clockwise to increase the delay, counter-clockwise to decrease the delay. You can select “Smpl” (samples) or “mSEC” (milliseconds) with the CURSOR buttons. Press the [ENTER] button to turn the delay on or off. See “Delay” on page 34 of the *User’s Guide*.

Note: *The fine-tuning procedure is not available from this display function. See “Fine-Tuning the Delay” on page 35 of the User’s Guide.*

Meter Source Point

When the cursor is located at this part of the display, as you press the [ENTER] button, you can cycle through the meter source points – PRE EQ, POST EQ, or POST FADER. There are also level meters for the channel pair (selected and its corresponding even or odd mate). See “Metering” on page 41 of the *User’s Guide*.

Groups and Channel ON

Use the CURSOR buttons to select the fader and mute group icons. Each time you press the [ENTER] button, the selected group will alternately be set or cancelled. Remember that a channel can only belong to one fader group and one mute group. See “Grouping Faders” on page 148 and “Grouping Mutes” on page 149 of the *User’s Guide*.

Press the [ON] button to turn the channel on or off. See “ON Buttons” on page 28 of the *User’s Guide*.

Beside the fader and mute group icons is the fader position icon. You cannot adjust this from the display, but it accurately reflects the current position of the channel fader. Displayed below the icon is the fader position in dB. See “Faders” on page 28 of the *User’s Guide*.

Auxiliary Sends

Select an auxiliary channel with the CURSOR buttons. Each time you press the [ENTER] button, the setting alternates between pre and post-fader. To adjust the signal or to turn the send on or off, you need to use the AUX controls in the SELECTED CHANNEL group. The SEND LEVEL control adjusts the signal level and the [ON] button turns the send on or off. See “The AUX Buttons” on page 85 as well as “AUX 7 and AUX 8” on page 92 of the *User’s Guide*.

Equalizer

When the cursor is on the ON icon, pressing the [ENTER] button will turn the equalizer on or off. When the equalizer is on, the icon text is “ON” and is displayed in reverse video.

Use the CURSOR buttons to select the EQ curve icon and press the [ENTER] button. The 02R will switch to the EQUALIZER display function. See “Equalizer” on page 49 of the *User’s Guide*. To return to the VIEW display function, press the [VIEW] button again.

You may find using the EQUALIZER controls in the SELECTED CHANNEL group a more convenient way to set the equalization. See “EQUALIZER controls” on page 51 of the *User’s Guide*.

Dynamics

When the cursor is on the OFF icon, pressing the [ENTER] button will turn the dynamics processor on or off. When the dynamics processor is off, the icon text is “OFF” and is displayed in normal video.

Use the CURSOR buttons to select the dynamics curve and press the [ENTER] button. The 02R will switch to the DYNAMICS display function. See “DYNAMICS Display Function” on page 69 of the *User’s Guide*. To return to the VIEW display function, press the [VIEW] button again.

If the selected channel is one of the effect return channels, dynamics is replaced by the EFFECT TYPE display. It shows the name of the current effects program for the channel. Use the CURSOR buttons to select the effects program name and press the [ENTER] button. The 02R will switch to the EFFECT display function. See “Effects” on page 94 of the *User’s Guide*. To return to the VIEW display function, press the [VIEW] button again.

Library

When the cursor is located on the LIB icon, press the [ENTER] button to access the channel library. You can also press the [VIEW] button again to achieve the same thing.

Channel Library

1. Press the (VIEW) button again.



The CHANNEL Library screen appears.

Storing Channel Programs

1. Select the STORE icon with the CURSOR button and use the encoder wheel to select a program number.
2. Use the CURSOR buttons and encoder wheel to name the program.
3. Press the (ENTER) button. The 02R pops up a confirmation request.
4. Select EXECUTE and press the (ENTER) button. The channel program is stored.

Recalling Channel Programs

1. Select the RECALL icon with the CURSOR buttons.
2. Use the encoder wheel to select a channel program.
3. Press the (ENTER) button. The channel program is recalled.

The Channel Library is used to access and store channel settings – stored as programs. There are 64 user programs (plus an UNDO buffer) for you to store your channel settings.

You can access this screen from the VIEW display function by selecting the LIB icon with the CURSOR buttons and pressing the [ENTER] button.

Display Screen

Shown below is the CHANNEL Library screen.

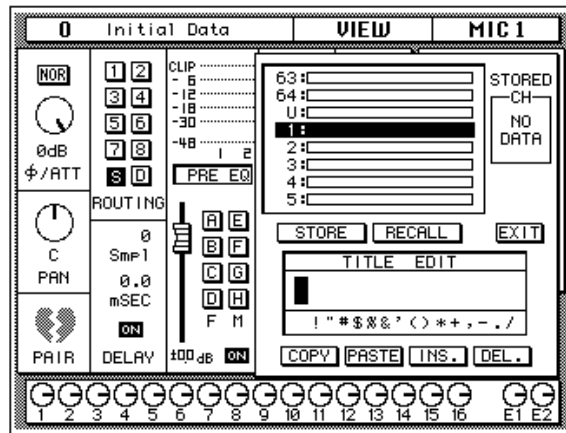

The Channel Library is overlaid on the previous VIEW display function screen.

The top of the display is a scrolling box containing the channel programs. The bottom of the display contains the control icons and the TITLE EDIT box. Use the CURSOR buttons to select from the STORE, RECALL, COPY, PASTE, INS., DEL., and EXIT control icons.

Selecting the EXIT icon and pressing the [ENTER] button switches back to the VIEW display function. You can also just press the [VIEW] button again.

Control Icons

- **STORE** – This icon is used to store the current program to the library. Select the icon with the CURSOR buttons. Use the encoder wheel to select a program and press the [ENTER] button. The 02R will display a popup confirmation request message asking if you want to store your settings in the selected program. The popup has two control icons: “CANCEL” and “EXECUTE”.

Note: You can customize your 02R to prevent the confirmation popup from appearing during the STORE operation. See “Preferences” on page 162 of the User’s Guide for more information.

CANCEL is the default. To cancel the STORE operation, either press the [ENTER] button or wait about 10 seconds – the STORE operation will be automatically cancelled.

To store your settings, use the CURSOR buttons to select the “EXECUTE” control icon and press the [ENTER] button. The program is stored.

When you confirm a STORE operation, any existing data in the selected program location will be overwritten.

YOU SHOULD ALWAYS BE CAREFUL WHEN THE 02R DISPLAYS ITS CONFIRMATION POPUP MESSAGE!

- **RECALL** – This icon is used to recall a program from the library. Select the icon with the CURSOR buttons. Use the encoder wheel to select a program and press the [ENTER] button. The recalled program is now the current program.
- **COPY** – This icon is used to copy the name of a library program. Select the icon with the CURSOR buttons. Use the encoder wheel to select a program and press the [ENTER] button. The program name is copied into an edit buffer.
- **PASTE** – This icon is used to paste a program name previously selected with the COPY operation into the TITLE EDIT box. Select the icon with the CURSOR buttons and press the [ENTER] button. The program name is pasted from the edit buffer into the TITLE EDIT box for subsequent editing.
- **INS.** – This icon is used to insert blank characters into the TITLE EDIT box at the current cursor location. Select the icon with the CURSOR buttons and press the [ENTER] button.
- **DEL.** – This icon is used to delete characters from the TITLE EDIT box at the current cursor location. Select the icon with the CURSOR buttons and press the [ENTER] button.

UNDO Operation

When the 02R stores or recalls a program, the previous settings are always preserved in the UNDO buffer. If you discover you have made a mistake, you can always recall the UNDO buffer (displayed as “U:” in the scrolling list of programs). Use the CURSOR buttons to select the RECALL icon, then rotate the encoder wheel until the UNDO buffer is the current program, and press the [ENTER] button. The previous settings are restored.

Program Name

Channel program names can be up to 16 characters long and can contain any of the following characters:

	!	“	#	\$	%	&	'	()	*	+	,	-	.	/
0	1	2	3	4	5	6	7	8	9	:	;	<	=	>	?
@	A	B	C	D	E	F	G	H	I	J	K	L	M	N	O
P	Q	R	S	T	U	V	W	X	Y	Z	[\]	^	_
`	a	b	c	d	e	f	g	h	i	j	k	l	m	n	o
p	q	r	s	t	u	v	w	x	y	z	{		}	~	

Equalizer

1. Press the (EQ) button.



The EQUALIZER display function appears.

2. Select a channel using the (SEL) buttons.
3. Use the CURSOR buttons to select the EQ ON icon. Press the (ENTER) button to turn the EQ on or off.

The icon changes from ON to OFF. When the EQ is on, the icon is highlighted in reverse video.

4. Select a control icon using the CURSOR buttons, for example the "F" control for the H-MID band.
5. To change the value of the selected item, rotate the encoder wheel until the desired value is shown.

The Digital Recording Console 02R is equipped with a four-band, fully parametric equalizer, with variable bandwidth, center frequency, gain, and ON/OFF parameters.

EQ can be applied to the input channels (MIC/LINE 1 through 16, LINE 17/18 through 23/24), the tape and effect return channels (TAPE 1 through 16, EFF1 and EFF2), and the stereo output. For stereo channels, the equalization curve is applied equally to both channels.

Display Screen

Shown below is the EQUALIZER display function:

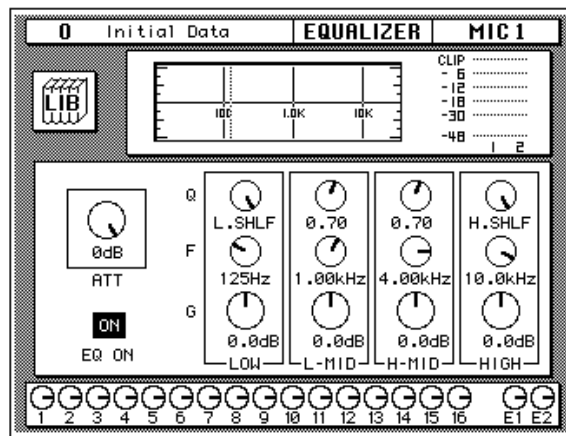

Similar to the VIEW display function, the EQUALIZER display function shows the equalization for the currently selected channel only.

The top of the display shows the EQ library icon, the equalization curve, and a level meter for the currently selected channel pair. The vertical dotted line in the equalization curve indicates the center frequency of the selected band.

The bottom of the display contains the control icons for adjusting the parameters for the currently selected channel:

- **ATT** – The attenuator rotary icon is used to set the channel level.

Note: The attenuator rotary icon is adjusting the same parameter as in the \emptyset /ATT display function. When you boost the gain of the equalization curve, you may cause the overall signal level to reach CLIP. Watch the level meters for the selected pair as you adjust the equalizer values. If CLIP is reached, digital signal distortion will occur.

- **EQ ON icon** – Indicates the status of the equalizer, on or off. The text "ON" is highlighted in reverse video when the equalizer is on.

- **Rotary icons** – There is an icon for bandwidth (Q), center frequency (F), and gain (G) for each of the four bands, LOW, L-MID, H-MID, and HIGH.

Use the CURSOR buttons to select the desired icon and adjust its value with the rotary encoder. Switch the equalizer on or off by pressing the [ENTER] button.

Equalization parameters:

	Q	F	G
LOW/HPF	Peak 10 to 0.1 in 41 steps / SHELF / HPF	21 Hz to 20.1 kHz in 1/12 octave steps ^{*1}	±18 dB in 0.5 dB steps HPF = ON/OFF
L-MID	Peak 10 to 0.1 in 41 steps	21 Hz to 20.1 kHz in 1/12 octave steps ^{*1}	±18 dB in 0.5 dB steps
H-MID	Peak 10 to 0.1 in 41 steps	21 Hz to 20.1 kHz in 1/12 octave steps ^{*1}	±18 dB in 0.5 dB steps
HIGH/LPF	Peak 10 to 0.1 in 41 steps / SHELF / LPF	21 Hz to 20.1 kHz in 1/12 octave steps ^{*1}	±18 dB in 0.5 dB steps LPF = ON/OFF

*1 When the sampling frequency is 32 kHz, the frequency range (F) is 21 Hz to 15.1 kHz

EQUALIZER controls

You can also adjust the equalization for the selected channel with the EQUALIZER controls in the SELECTED CHANNEL group.

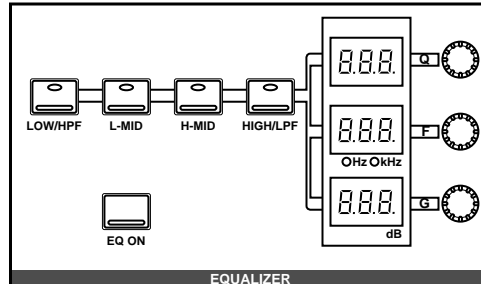

These controls allow you to adjust the equalization of the selected channel. Select the band you want to adjust with one of the buttons in the top row: [LOW/HPF], [L-MID], [H-MID], or [HIGH/LPF]. The three LED indicators will reflect the status of the selected band. Adjust the values, Q (bandwidth), F (frequency), and G (gain), with the corresponding rotary encoders. Use the [EQ ON] button to insert the equalization into the channel.

Note: You can customize your 02R so that when you adjust any of the controls in this group, the display switches to the EQUALIZER display function. See "Preferences" on page 162 of the User's Guide.

Reset the Gain

You can reset the gain of each band to 0.0 dB by double-clicking the corresponding [LOW/HPF], [L-MID], [H-MID], or [HIGH/LPF] buttons.

Reset the Equalizer

You can reset all the values of the equalizer for the selected channel. Press and hold the [LOW/HPF] button and then press the [HIGH/LPF] button.

All the equalizer values will be reset to their default.

	LOW/HPF	L-MID	H-MID	HIGH/LPF
Q	LOW SHELF	Peak – 0.7	Peak – 0.7	HIGH SHELF
F	125 Hz	1.00 kHz	4.00 kHz	10.0 kHz
G	0dB	0dB	0dB	0dB

Equalizer Programs

These are the preset equalizer programs.

No	Program Name	No	Program Name
1	Bass Drum 1	21	A.G.Stroke 2
2	Bass Drum 2	22	A.G.Arpeggio 1
3	Snare Drum 1	23	A.G.Arpeggio 2
4	Snare Drum 2	24	Brass Section
5	Tom-tom 1	25	Male Vocal 1
6	Cymbal	26	Male Vocal 2
7	High Hat	27	Female Vocal 1
8	Percussion	28	Female Vocal 2
9	E.Bass 1	29	Chorus & Harmony
10	E.Bass 2	30	Total EQ 1
11	Syn.Bass 1	31	Total EQ 2
12	Syn.Bass 2	32	Total EQ 3
13	Piano 1	33	Bass Drum 3
14	Piano 2	34	Snare Drum 3
15	E.G.Clean	35	Tom-tom 2
16	E.G.Crunch 1	36	Piano 3
17	E.G.Crunch 2	37	Piano Low
18	E.G.Distortion 1	38	Piano High
19	E.G.Distortion 2	39	Fine-EQ(Cass)
20	A.G.Stroke 1	40	Narrator

Note: *The programs 33 to 40 contain preset programs and are listed in the table above. However, you can store your own settings to these programs.*

Equalizer Library

1. Press the (EQ) button again.



The EQUALIZER Library display function appears.

The Equalizer Library is used to access and store EQ settings – stored as programs. There are 40 preset programs (1 to 40) for you to recall and 88 user programs (41 to 128 plus UNDO) for you to store your own EQ settings.

You can access this screen from the EQUALIZER display function by selecting the LIB icon with the CURSOR buttons and pressing the [ENTER] button.

Display Screen

Shown below is the EQUALIZER Library display screen.

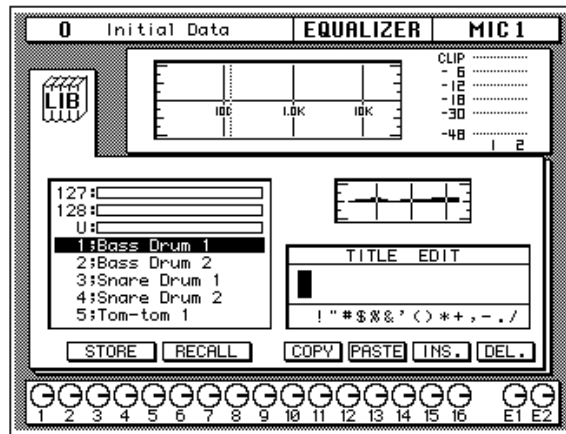

Recalling EQ Programs

1. Select a channel using the (SEL) buttons.
2. Use the CURSOR buttons to select the RECALL icon and select an EQ program with the encoder wheel.
3. Press the (ENTER) button. The EQ program is recalled.

Storing EQ Programs

1. Use the CURSOR buttons to select the STORE icon and select an EQ program with the encoder wheel.
2. Use the CURSOR buttons and encoder wheel to name the program.
3. Press the (ENTER) button. The 02R pops up a confirmation request.
4. Select EXECUTE and press the (ENTER) button. The EQ program is stored.

The top of the display shows the EQ library icon, the equalization curve, and a level meter for the currently selected channel pair.

The middle of the display shows a scrolling list of EQ programs. The name of the EQ program under the cursor is highlighted. The encoder wheel is used to scroll through the program list. A small diagram of the response curve of the highlighted EQ program is shown to the right.

Beside the list of EQ programs is the TITLE EDIT field. The CURSOR buttons are used to select the character, and the encoder wheel is used to change its value.

The bottom of the display contains the control button icons. Use the CURSOR buttons to select from the STORE, RECALL, COPY, PASTE, INS., and DEL. icons.

Exiting the Library

Selecting the LIB icon and pressing the [ENTER] button switches back to the EQUALIZER display function. You can also press the [EQ] button again.

Control Icons

- **STORE** – This icon is used to store the current program to the library. Select the icon with the CURSOR buttons. Use the encoder wheel to select a program and press the [ENTER] button. The 02R will display a popup confirmation request message asking if you want to store your settings in the selected program. The popup has two control icons: “CANCEL” and “EXECUTE”.

Note: *You can customize your 02R to prevent the confirmation popup from appearing during the STORE operation. See “Preferences” on page 162 of the User’s Guide for more information.*

CANCEL is the default. To cancel the STORE operation, either press the [ENTER] button or wait about 10 seconds – the STORE operation will be automatically cancelled.

To store your settings, use the CURSOR buttons to select the “EXECUTE” control icon and press the [ENTER] button. The program is stored.

When you confirm a STORE operation, any existing data in the selected program location will be overwritten.

YOU SHOULD ALWAYS BE CAREFUL WHEN THE 02R DISPLAYS ITS CONFIRMATION POPUP MESSAGE!

- **RECALL** – This icon is used to recall a program from the library. Select the icon with the CURSOR buttons. Use the encoder wheel to select a program and press the [ENTER] button. The recalled program is now the current program.
- **COPY** – This icon is used to copy the name of a library program. Select the icon with the CURSOR buttons. Use the encoder wheel to select a program and press the [ENTER] button. The program name is copied into an edit buffer.
- **PASTE** – This icon is used to paste a program name previously selected with the COPY operation into the TITLE EDIT box. Select the icon with the CURSOR buttons and press the [ENTER] button. The program name is pasted from the edit buffer into the TITLE EDIT box for subsequent editing.
- **INS.** – This icon is used to insert blank characters into the TITLE EDIT box at the current cursor location. Select the icon with the CURSOR buttons and press the [ENTER] button.
- **DEL.** – This icon is used to delete characters from the TITLE EDIT box at the current cursor location. Select the icon with the CURSOR buttons and press the [ENTER] button.

UNDO Operation

When the 02R stores or recalls a program, the previous settings are always preserved in the UNDO buffer. If you discover you have made a mistake, you can always recall the UNDO buffer (displayed as "U:" in the scrolling list of programs). Use the CURSOR buttons to select the RECALL icon, then rotate the encoder wheel until the UNDO buffer is the current program, and press the [ENTER] button. The previous settings are restored.

Program Name

Equalizer program names can be up to 16 characters long and can contain any of the following characters:

	!	"	#	\$	%	&	'	()	*	+	,	-	.	/
0	1	2	3	4	5	6	7	8	9	:	;	<	=	>	?
@	A	B	C	D	E	F	G	H	I	J	K	L	M	N	O
P	Q	R	S	T	U	V	W	X	Y	Z	[\]	^	_
`	a	b	c	d	e	f	g	h	i	j	k	l	m	n	o
p	q	r	s	t	u	v	w	x	y	z	{		}	~	

Preset EQ Program Parameters

No	Name	Parameter				Description	
		LOW	L-MID	H-MID	HIGH		
1	Bass Drum 1		PEAKING	PEAKING	PEAKING	H.SHELF	Emphasizes the low range of the bass drum and the attack created by the beater.
		Q	1.2	10	0.9		
		F	99Hz	265Hz	1.05kHz	5.33kHz	
		G	+3.5dB	-3.5dB	0.0dB	+4.0dB	
2	Bass Drum 2		PEAKING	PEAKING	PEAKING	LPF	Creates a peak around 80Hz, producing a tight, stiff sound.
		Q	1.4	4.5	2.2		
		F	79Hz	397Hz	2.52kHz	12.6kHz	
		G	+8.0dB	-7.0dB	+6.0dB	ON	
3	Snare Drum 1		PEAKING	PEAKING	PEAKING	H.SHELF	Emphasizes snapping and rimshot sounds.
		Q	1.2	4.5	0.11		
		F	132Hz	1.00kHz	3.17kHz	5.04kHz	
		G	-0.5dB	0.0dB	+3.0dB	+4.5dB	
4	Snare Drum 2		L.SHELF	PEAKING	PEAKING	PEAKING	Emphasizes the ranges of that classic rock snare drum sound.
		Q		10	0.7	0.1	
		F	177Hz	334Hz	2.37kHz	4.00kHz	
		G	+1.5dB	-8.5dB	+2.5dB	+4.0dB	
5	Tom-tom 1		PEAKING	PEAKING	PEAKING	PEAKING	Emphasizes the attack of tom-toms, and creates a long, "leathery" decay.
		Q	1.4	10	1.2	0.28	
		F	210Hz	667Hz	4.49kHz	6.35kHz	
		G	+2.0dB	-7.5dB	+2.0dB	+1.0dB	
6	Cymbal		L.SHELF	PEAKING	PEAKING	H.SHELF	Emphasizes the attack of crash cymbals, extending the "sparkling" decay.
		Q		8	0.9		
		F	105Hz	420Hz	1.05kHz	13.4kHz	
		G	-2.0dB	0.0dB	0.0dB	+3.0dB	
7	High Hat		L.SHELF	PEAKING	PEAKING	H.SHELF	Use on a tight high-hat, emphasizing the mid to high range.
		Q		0.5	1		
		F	94Hz	420Hz	2.82kHz	7.55kHz	
		G	-4.0dB	-2.5dB	+1.0dB	+0.5dB	
8	Percussion		L.SHELF	PEAKING	PEAKING	H.SHELF	Emphasizes the attack and clarifies the high-range of instruments, such as shakers, cabanas, and congas.
		Q		4.5	0.56		
		F	99Hz	397Hz	2.82kHz	16.9kHz	
		G	-4.5dB	0.0dB	+2.0dB	0.0dB	
9	E.Bass 1		L.SHELF	PEAKING	PEAKING	H.SHELF	Makes a tight electric bass sound by cutting very low frequencies.
		Q		5	4.5		
		F	35Hz	111Hz	2.00kHz	4.00kHz	
		G	-7.5dB	+4.5dB	+2.5dB	0.0dB	

No	Name	Parameter				Description	
		LOW	L-MID	H-MID	HIGH		
10	E.Bass 2		PEAKING	PEAKING	PEAKING	H.SHELF	Unlike program 9, this emphasizes the high range of the electric bass.
		Q	0.1	5	6.3		
		F	111Hz	111Hz	2.24kHz	4.00kHz	
		G	+3.0dB	0.0dB	+2.5dB	+0.5dB	
11	Syn.Bass 1		PEAKING	PEAKING	PEAKING	H.SHELF	Use on a synth bass with emphasized low range.
		Q	0.1	8	4.5		
		F	83Hz	944Hz	4.00kHz	12.6kHz	
		G	+3.5dB	+8.5dB	0.0dB	0.0dB	
12	Syn.Bass 2		PEAKING	PEAKING	PEAKING	H.SHELF	Emphasizes the attack that is peculiar to a synth bass.
		Q	1.6	8	2.2		
		F	125Hz	177Hz	1.12kHz	12.6kHz	
		G	+2.5dB	0.0dB	+1.5dB	0.0dB	
13	Piano 1		L.SHELF	PEAKING	PEAKING	H.SHELF	This is used to make a piano sound brighter.
		Q		8	0.9		
		F	94Hz	944Hz	3.17kHz	7.55kHz	
		G	-6.0dB	0.0dB	+2.0dB	+4.0dB	
14	Piano 2		PEAKING	PEAKING	PEAKING	H.SHELF	Emphasize the attack and low range of the piano sound by using a compressor.
		Q	5.6	10	0.7		
		F	223Hz	595Hz	3.17kHz	5.33kHz	
		G	+3.5dB	-8.5dB	+1.5dB	+3.0dB	
15	E.G.Clean		PEAKING	PEAKING	PEAKING	H.SHELF	Use for line-recording an electric guitar or semi-acoustic guitar to get a slightly hard sound.
		Q	0.18	10	6.3		
		F	265Hz	397Hz	1.33kHz	4.49kHz	
		G	+2.0dB	-5.5dB	+0.5dB	+2.5dB	
16	E.G.Crunch 1		PEAKING	PEAKING	PEAKING	PEAKING	Adjusts the tonal quality of a slightly distorted guitar sound.
		Q	8	4.5	0.63	9	
		F	140Hz	1.00kHz	1.88kHz	5.65kHz	
		G	+4.5dB	0.0dB	+4.0dB	+2.0dB	
17	E.G.Crunch 2		PEAKING	PEAKING	PEAKING	H.SHELF	This is a variation on program 16.
		Q	8	0.4	0.16		
		F	125Hz	445Hz	3.36kHz	19.0kHz	
		G	+2.5dB	+1.5dB	+2.5dB	0.0dB	
18	E.G.Distortion 1		L.SHELF	PEAKING	PEAKING	H.SHELF	Makes a heavily distorted guitar sound clearer.
		Q		9	10		
		F	354Hz	944Hz	3.36kHz	12.6kHz	
		G	+5.0dB	0.0dB	+3.5dB	0.0dB	
19	E.G.Distortion 2		L.SHELF	PEAKING	PEAKING	H.SHELF	This is a variation on program 18.
		Q		10	4		
		F	315Hz	1.05kHz	4.23kHz	12.6kHz	
		G	+6.0dB	-8.5dB	+4.5dB	+4.0dB	

No	Name	Parameter				Description	
		LOW	L-MID	H-MID	HIGH		
20	A.G.Stroke 1		PEAKING	PEAKING	PEAKING	H.SHELF	Emphasizes the bright tones of an acoustic guitar.
		Q	0.9	4.5	3.5		
		F	105Hz	1.00kHz	1.88kHz	5.33kHz	
		G	-2.0dB	0.0dB	+1.0dB	+4.0dB	
21	A.G.Stroke 2		L.SHELF	PEAKING	PEAKING	H.SHELF	This is a variation on program 20. You can also use it for the electric gut guitar.
		Q		9	4.5		
		F	297Hz	749Hz	2.00kHz	3.56kHz	
		G	-3.5dB	-2.0dB	0.0dB	+2.0dB	
22	A.G.Arpeggio 1		L.SHELF	PEAKING	PEAKING	PEAKING	Corrects arpeggio technique of an acoustic guitar.
		Q		4.5	4.5	0.12	
		F	223Hz	1.00kHz	4.00kHz	6.72kHz	
		G	-0.5dB	0.0dB	0.0dB	+2.0dB	
23	A.G.Arpeggio 2		L.SHELF	PEAKING	PEAKING	H.SHELF	This is a variation on program 22.
		Q		7	4.5		
		F	177Hz	354Hz	4.00kHz	4.23kHz	
		G	0.0dB	-5.5dB	0.0dB	+4.0dB	
24	Brass Section		PEAKING	PEAKING	PEAKING	PEAKING	Use with trumpets, trombones, or sax. With one instrument, adjust the HIGH or H-MID frequency.
		Q	2.8	2	0.7	7	
		F	88Hz	841Hz	2.11kHz	4.49kHz	
		G	-2.0dB	+1.0dB	+1.5dB	+3.0dB	
25	Male Vocal 1		PEAKING	PEAKING	PEAKING	PEAKING	Use as a template for male vocal. Adjust the HIGH or H-MID setting according to the voice quality.
		Q	0.11	4.5	0.56	0.11	
		F	187Hz	1.00kHz	2.00kHz	6.72kHz	
		G	-0.5dB	0.0dB	+2.0dB	+3.5dB	
26	Male Vocal 2		PEAKING	PEAKING	PEAKING	H.SHELF	This is a variation on program 25.
		Q	0.11	10	5.6		
		F	167Hz	236Hz	2.67kHz	6.72kHz	
		G	+2.0dB	-5.0dB	+2.5dB	+4.0dB	
27	Female Vocal 1		PEAKING	PEAKING	PEAKING	PEAKING	Use as a template for female vocal. Adjust the HIGH or H-MID setting according to the voice quality.
		Q	0.18	0.45	0.56	0.14	
		F	118Hz	397Hz	2.67kHz	5.99kHz	
		G	-1.0dB	+1.0dB	+1.5dB	+2.0dB	
28	Female Vocal 2		L.SHELF	PEAKING	PEAKING	H.SHELF	This is a variation on program 27
		Q		0.16	0.2		
		F	111Hz	334Hz	2.00kHz	6.72kHz	
		G	-7.0dB	+1.5dB	+1.5dB	+2.5dB	
29	Chorus & Harmony		PEAKING	PEAKING	PEAKING	PEAKING	Use as a template for a chorus. It makes the entire chorus much brighter.
		Q	2.8	2	0.7	7	
		F	88Hz	841Hz	2.11kHz	4.49kHz	
		G	-2.0dB	+1.0dB	+1.5dB	+3.0dB	

No	Name	Parameter				Description	
		LOW	L-MID	H-MID	HIGH		
30	Total EQ 1		PEAKING	PEAKING	PEAKING	H.SHELF	Use on the STEREO bus during mixdown. For more effect, try it with a compressor.
		Q	7	2.2	5.6		
		F	94Hz	944Hz	2.11kHz	16.0kHz	
		G	-0.5dB	0.0dB	+3.0dB	+6.5dB	
31	Total EQ 2		PEAKING	PEAKING	PEAKING	H.SHELF	This is a variation on program 30.
		Q	7	2.8	5.6		
		F	94Hz	749Hz	1.78kHz	17.9kHz	
		G	+4.0dB	+1.5dB	+2.0dB	+6.0dB	
32	Total EQ 3		L.SHELF	PEAKING	PEAKING	H.SHELF	This is a variation on program 30. Also use these programs for stereo inputs or external effect returns.
		Q		0.28	0.7		
		F	66Hz	841Hz	1.88kHz	15.1kHz	
		G	+1.5dB	+0.5dB	+2.0dB	+4.0dB	
33	Bass Drum 3		PEAKING	PEAKING	PEAKING	PEAKING	This is a variation on program 1. The low and mid range is removed.
		Q	2	10	0.4	0.4	
		F	118Hz	315Hz	4.23kHz	20.1kHz	
		G	+3.5dB	-10.0dB	+3.5dB	0.0dB	
34	Snare Drum 3		L.SHELF	PEAKING	PEAKING	PEAKING	This is a variation on program 3. It creates rather thick sound.
		Q		4.5	2.8	0.1	
		F	223Hz	561Hz	4.23kHz	4.00kHz	
		G	0.0dB	+2.0dB	+3.5dB	0.0dB	
35	Tom-tom 2		L.SHELF	PEAKING	PEAKING	H.SHELF	This is a variation on program 5. Emphasizes the mid and high range.
		Q		4.5	1.2		
		F	88Hz	210Hz	5.33kHz	16.9kHz	
		G	-9.0dB	+1.5dB	+2.0dB	0.0dB	
36	Piano 3		PEAKING	PEAKING	PEAKING	H.SHELF	This is a variation on program 13.
		Q	8	10	9		
		F	99Hz	472Hz	2.37kHz	10.0kHz	
		G	+4.5dB	-13.0dB	+4.5dB	+2.5dB	
37	Piano Low		PEAKING	PEAKING	PEAKING	H.SHELF	Use for the low range of the piano sound when it is recorded in stereo. Use with program 38.
		Q	10	6.3	2.2		
		F	187Hz	397Hz	6.72kHz	12.6kHz	
		G	-5.5dB	+1.5dB	+6.0dB	0.0dB	

No	Name	Parameter				Description	
		LOW	L-MID	H-MID	HIGH		
38	Piano High		PEAKING	PEAKING	PEAKING	PEAKING	Use for the high range of the piano sound when it is recorded in stereo. Use with program 37.
		Q	10	6.3	2.2	0.1	
		F	187Hz	397Hz	6.72kHz	5.65kHz	
		G	-5.5dB	+1.5dB	+5.0dB	+3.0dB	
39	Fine-EQ(Cass)		L.SHELF	PEAKING	PEAKING	H.SHELF	Use for recording to or from cassette tape to make the sound clearer.
		Q		4.5	1.8		
		F	74Hz	1.00kHz	4.00kHz	12.6kHz	
		G	-1.5dB	0.0dB	+1.0dB	+3.0dB	
40	Narrator		PEAKING	PEAKING	PEAKING	H.SHELF	Use for recording a voice reading a text.
		Q	4	7	0.63		
		F	105Hz	707Hz	2.52kHz	10.0kHz	
		G	-4.0dB	-1.0dB	+2.0dB	0.0dB	

Note: *These equalizer settings were programmed for recording acoustic musical instruments. If you are using them for a sampler, synthesizer, or rhythm machine, adjust the parameters accordingly.*

Note: *The programs 33 to 40 contain preset programs and are listed in the table above. However, you can store your own settings to these programs.*

5

Dynamics

In this chapter...

Dynamics Processors.....	62
Preset Dynamics Programs	62
Compressor.....	63
Expander.....	65
Compander.....	66
Gate and Ducking	67
DYNAMICS Display Function	69
Patching in a Processor.....	70
Dynamics Processor Meters.....	71
KEY IN and LINK Indicators.....	72
Dynamics Library	73
Preset Dynamics Program Parameters.....	76

Dynamics Processors

Dynamics processors are generally used to correct or control signal levels. However, you can also use them creatively to shape the volume envelope of a sound. The Digital Recording Console 02R features comprehensive dynamics processors for all the input channels, tape returns, and the bus and stereo outputs. These processors allow you to compress, expand, compress-expand (compand), gate, or duck the signals passing through the mixer, giving you unparalleled sonic quality and flexibility.

Preset Dynamics Programs

These are the preset dynamics programs.

No	Program Name	No	Program Name
1	A.Dr.BD "CMP	21	BrassSection "CMP
2	A.Dr.BD "EXP	22	Syn.Pad "CMP
3	A.Dr.BD "GAT	23	SamplingPerc "CPS
4	A.Dr.BD "CPH	24	Sampling BD "CMP
5	A.Dr.SN "CMP	25	Sampling SN "CMP
6	A.Dr.SN "EXP	26	Hip Comp "CPS
7	A.Dr.SN "GAT	27	Solo Vocal1 "CMP
8	A.Dr.SN "CPS	28	Solo Vocal2 "CMP
9	A.Dr.Tom "EXP	29	Chorus "CMP
10	A.Dr.OverTop "CPS	30	Compander(H) "CPH
11	E.B.finger "CMP	31	Compander(S) "CPS
12	E.B.slap "CMP	32	Click Erase "EXP
13	Syn.Bass "CMP	33	Announcer "CPH
14	Piano1 "CMP	34	Easy Gate "GAT
15	Piano2 "CMP	35	BGM Ducking "DUK
16	E.Guitar "CMP	36	Limiter1 "CPS
17	A.Guitar "CMP	37	Limiter2 "CMP
18	Strings1 "CMP	38	Total Comp1 "CMP
19	Strings2 "CMP	39	Total Comp2 "CMP
20	Strings3 "CMP	40	Total Comp3 "CMP

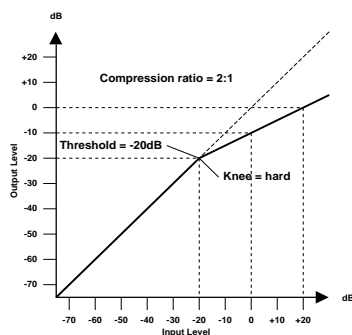

Compressor

A compressor provides a form of automatic level control. By attenuating high levels, thus effectively reducing the dynamic range, the compressor makes it much easier to control signals and set appropriate fader levels. Reducing the dynamic range also means that recording levels can be set higher, therefore improving the signal-to-noise performance.

Compressor (CMP) parameters:

Parameter	Value
Threshold (dB)	-54 to 0 (55 points)
Ratio	1.0, 1.1, 1.3, 1.5, 1.7, 2.0, 2.5, 3.0, 3.5, 4.0, 5.0, 6.0, 8.0, 10, 20, ∞ (16 points)
Attack (ms)	0 to 120 (121 points)
Outgain (dB)	0 to +18 (36 points)
Knee	hard, 1, 2, 3, 4, 5 (6 points)
Release (ms)	5 ms to 42.3 sec ^{*1} , 6 ms to 46.0 sec ^{*2} , 8 ms to 63.4 sec ^{*3} (160 points)

*1 These values are obtained when the sampling frequency is 48 kHz.

*2 These values are obtained when the sampling frequency is 44.1 kHz.

*3 These values are obtained when the sampling frequency is 32 kHz

Threshold determines the level of input signal required to trigger the compressor. Signals at a level below the threshold pass through unaffected. Signals at and above the threshold level are compressed by the amount specified using the Ratio parameter. The trigger signal is determined using the KEY IN parameter.

Note: See "KEY IN" on page 70 of the User's Guide for an explanation of the KEY IN parameter.

Ratio controls the amount of compression - the change in output signal level relative to change in input signal level. With a 2:1 ratio, for example, a 10 dB change in input level (above the threshold) results in a 5 dB change in output level. For a 5:1 ratio, a 10 dB change in input level (above the threshold) results in a 2 dB change in output level.

Attack controls how soon the signal is compressed once the compressor has been triggered. With a fast attack time, the signal is compressed almost immediately. With a slow attack time, the initial transient of a sound passes through unaffected.

Out Gain sets the compressor's output signal level. Compression tends to reduce the average signal level. Out Gain can be used to counter this level reduction and set an appropriate level for the next stage in the audio path.

Knee sets the transition of the signal at the threshold. With a hard knee, the transition between uncompressed and compressed signal is immediate. With the softest knee, *knee5*, the transition starts before the signal reaches the threshold and gradually ends above the threshold.

Release determines how soon the compressor returns to its normal gain once the trigger signal level drops below the threshold. If the release time is too short, the gain will recover too quickly causing level pumping - noticeable gain fluctuations. If it is set too long, the compressor may not have time to recover before the next high level signal appears, and it will be compressed incorrectly.

Expander

An expander is another form of automatic level control. By attenuating the signal below the threshold, the expander reduces low-level noise and effectively increases the dynamic range of the recorded material.

Expander (EXP) parameters:

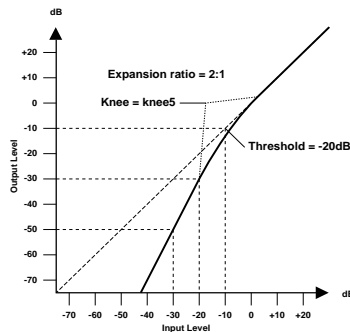
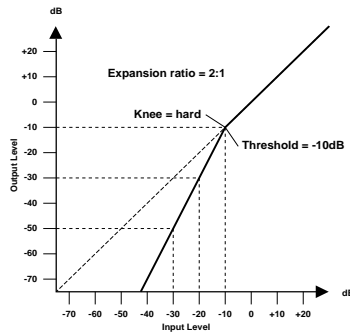

Parameter	Value
Threshold (dB)	-54 to 0 (55 points)
Ratio	1.0, 1.1, 1.3, 1.5, 1.7, 2.0, 2.5, 3.0, 3.5, 4.0, 5.0, 6.0, 8.0, 10, 20, ∞ (16 points)
Attack (ms)	0 to 120 (121 points)
Outgain (dB)	0 to +18 (36 points)
Knee	hard,1,2,3,4,5 (6 points)
Release (ms)	5 ms to 42.3 sec ^{*1} , 6 ms to 46.0 sec ^{*2} , 8 ms to 63.4 sec ^{*3} (160 points)

*1 These values are obtained when the sampling frequency is 48kHz.

*2 These values are obtained when the sampling frequency is 44.1 kHz.

*3 These values are obtained when the sampling frequency is 32 kHz

Threshold determines the level of input signal required to trigger the expander. Signals above the threshold pass through unaffected. Signals at and below the threshold level are attenuated by the amount specified using the Ratio parameter. The trigger signal is determined using the KEY IN parameter.

Ratio controls the amount of expansion - the change in output signal level relative to change in input signal level. With a 1:2 ratio, for example, a 5 dB change in input level (below the threshold) results in a 10 dB change in output level. For a 1:5 ratio, a 2 dB change in input level (below the threshold) results in a 10 dB change in output level.

Attack controls how soon the signal is expanded once the expander has been triggered. With a fast attack time, the signal is expanded almost immediately. With a slow attack time, the initial transient of a sound passes through unaffected.

Out Gain sets the expander's output signal level.

Knee sets the transition of the signal at the threshold. With a hard knee, the transition between unexpanded and expanded signal is immediate. With the softest knee, knee5, the transition starts before the signal reaches the threshold and gradually ends above the threshold.

Release determines how soon the expander returns to its normal gain once the trigger signal level drops below the threshold.

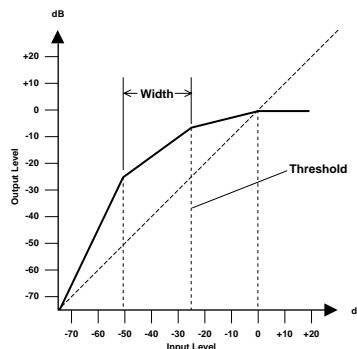

Compander

A compander is a compressor-expander - a combination of signal compression and expansion. The compander attenuates the input signal above the threshold as well as the level below the width. For very dynamic material, this program allows you to retain the dynamic range without having to be concerned with excessive output signal levels and clipping.

CompanderH (CPH) and CompanderS (CPS) parameters:

Parameter	Value
Threshold (dB)	-54 to 0 (55 points)
Ratio	1.0, 1.1, 1.3, 1.5, 1.7, 2.0, 2.5, 3.0, 3.5, 4.0, 5.0, 6.0, 8.0, 10, 20 (15 points)
Attack (ms)	0 to 120 (121 points)
Outgain (dB)	-18 to 0 (36 points)
Width (dB)	1 to 90 (90 points)
Release (ms)	5 ms to 42.3 sec ^{*1} , 6 ms to 46.0 sec ^{*2} , 8 ms to 63.4 sec ^{*3} (160 points)

*1 These values are obtained when the sampling frequency is 48kHz.

*2 These values are obtained when the sampling frequency is 44.1 kHz.

*3 These values are obtained when the sampling frequency is 32 kHz

Threshold determines the level of input signal required to trigger the compander. Signals above the threshold pass through unaffected. Signals at and below the threshold level are attenuated by the amount specified using the Ratio parameter. The trigger signal is determined using the KEY IN parameter.

Ratio controls the amount of companding - the change in output signal level relative to change in input signal level. With a 2:1 ratio, for example, a 10 dB change in input level (above the threshold) results in a 5 dB change in output level. The hard compander (CPH) has a fixed ratio of 5:1 for expansion and the soft compander (CPS) has a fixed ratio of 1.5:1 for expansion.

Attack controls how soon the signal is companded once the compander has been triggered. With a fast attack time, the signal is companded almost immediately. With a slow attack time, the initial transient of a sound passes through unaffected.

Out Gain sets the compander's output signal level.

Width is used to determine the distance, in decibels, between the expander and the compressor. With a width of 90dB, the expander is effectively switched off and the compander is simply a compressor-limiter. With a smaller width (30dB) and a high threshold (0dB), the compander is an expander-compressor-limiter.

Release determines how soon the compander returns to its normal gain once the trigger signal level drops below the threshold.

Gate and Ducking

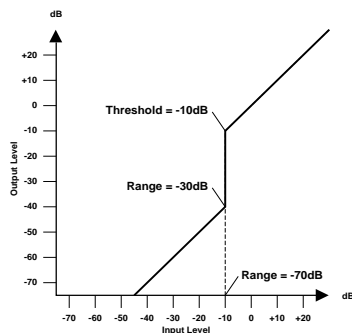

A gate, or noise gate is an audio switch used to mute signals below a set threshold level. It can be used to suppress background noise and hiss from valve (tube) amps, effects pedals, and microphones.

Ducking is used to automatically reduce the levels of one signal when the level of a source signal exceeds a specified threshold. It is used for voice-over applications where, for example, level of background music is automatically reduced, allowing an announcer to be heard clearly.

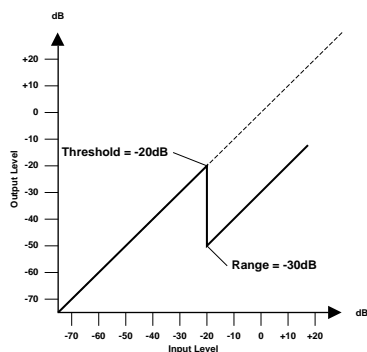

Gate (GAT) and Ducking (DUK) parameters:

Parameter	Value
Threshold (dB)	-54 to 0 (55 points)
Range (dB)	-70 to 0 (71 points)
Attack (ms)	0 to 120 (121 points)
Hold (ms)	0.02 ms to 1.96s ^{*1} , 0.02 ms to 2.13 sec ^{*2} , 0.03 ms to 2.94 sec ^{*3} (216 points)
Decay (ms)	5ms to 42.3s ^{*1} , 6 ms to 46.0 sec ^{*2} , 8 ms to 63.4 sec ^{*3} (160 points)

*1 These values are obtained when the sampling frequency is 48kHz.

*2 These values are obtained when the sampling frequency is 44.1 kHz.

*3 These values are obtained when the sampling frequency is 32 kHz

Threshold sets the level at which the gate closes, cutting off the signal. Signals above the threshold level pass through unaffected. Signals at or below the threshold cause the gate to close.

For ducking, trigger signal levels at and above the threshold level activate ducking, and the signal level is reduced to a level set by the Range parameter.

The trigger signal is determined using the KEY IN parameter.

Range controls the level to which the gate closes. It can be used to reduce the signal level rather than cut it completely. At a setting of -70 dB, the gate closes completely when the input signal falls below the threshold. At a setting of -30 dB, the gate only closes so far allowing an attenuated signal through. At a setting of 0 dB, the gate has no effect. When signals are gated abruptly, the sudden cut-off can sound odd.

For ducking, a setting of -70 dB causes the signal to be virtually cutoff. At a setting of -30 dB the signal is ducked by 30 dB. At a setting of 0 dB, the duck has no effect.

Attack determines how fast the gate opens when the signal exceeds the threshold level. Slow attack times can be used to remove the initial transient edge of percussive sounds. Too slow an attack time makes some signals sound backwards.

For ducking, this controls how soon the signal is ducked once the duck has been triggered. With a fast attack time, the signal is ducked almost immediately. With a slow attack time, ducking fades the signal. Too fast an attack time may sound abrupt.

Hold sets how long the gate stays open or the ducking remains active once the trigger signal has fallen below the threshold level.

Decay controls how fast the gate closes once the hold time has expired. A longer decay time produces a more natural gating effect, allowing the natural decay of an instrument to pass through.

For ducking, this determines how soon the ducker returns to its normal gain after the hold time has expired.

DYNAMICS Display Function

1. Press the (DYNAMICS) button.



The DYNAMICS display function appears.

2. Select a channel using the (SEL) buttons.

Note: Press the [SEL] button for the STEREO channel to access the dynamics processors for the output buses.

Dynamics can be applied to the input channels (MIC/LINE 1 through 16, LINE 17/18 through 23/24), the tape return channels (TAPE 1 through 16), the internal bus outputs (BUS 1 through 8), and the stereo output. For stereo channels when the link is on, the dynamics processor is applied equally to both channels.

Display Screen

Shown below is the DYNAMICS display function:

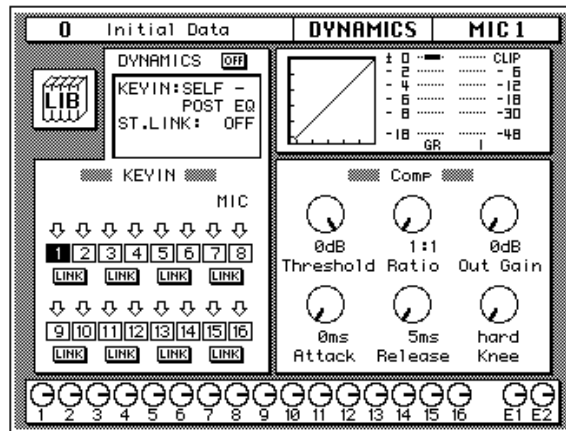

Similar to the EQUALIZER display function, the DYNAMICS display function shows the dynamics settings for the currently selected channel only.

The top of the display contains the Dynamics library icon, the DYNAMICS icon, the main control prompts (KEY IN, ST.LINK, and optionally IN), the dynamics graph, and the gain reduction meter plus a level meter for the currently selected channel pair.

The bottom of the display is split into two main sections:

The first section shows the channel KEY IN settings and LINK icons. These settings can be changed by the CURSOR buttons, the encoder wheel, and [ENTER] button.

The second section contains the controls for adjusting the parameters for the currently selected channel. There are rotary icons for the threshold, ratio, output gain, attack, release, and so on, depending on which dynamics program you have selected. Use the CURSOR buttons to select the desired icon and adjust its value with the encoder wheel. Press the [ENTER] button to turn the dynamics processor on or off.

Patching in a Processor

1. To turn the dynamics processor on, use the CURSOR buttons to select the DYNAMICS icon and press the (ENTER) button.

The icon changes from OFF to ON and is highlighted in reverse video.

2. Use the CURSOR buttons to select the KEY IN prompt and rotate the encoder wheel or press the (ENTER) button to select a trigger source.

3. Use the CURSOR buttons to select the ST.LINK prompt and rotate the encoder wheel or press the (ENTER) button to turn the stereo link on or off.

4. If the stereo link is on, use the CURSOR buttons to select the IN prompt and rotate the encoder wheel or press the (ENTER) button to select the channels to patch the dynamics processor into.

DYNAMICS Icon

The DYNAMICS ON/OFF icon is used to turn the dynamics processor on or off for the selected channel.

Control Prompts

The main control prompts are used to patch a dynamics processor into a channel or stereo pair:

Prompt	Value
KEY IN	SELF - POST EQ, SELF - PRE EQ, LEFT - POST EQ, LEFT - PRE EQ, AUX 1, AUX 2
ST.LINK	ON, OFF
IN	BOTH, L (left/odd), R (right/even)

KEY IN selects the processor trigger source - the signal that triggers, or activates the processor. You can select the current channel either before or after equalization, the left channel (again either before or after equalization), or either AUX 1 or AUX 2.

You cannot select the left channel (before or after equalization) for the first input channel, MIC/LINE 1, the first tape return channel, TAPE 1, the first bus channel, or the stereo output channel.

ST.LINK determines if a channel pair is to be linked together. You cannot turn it off when the channel pair has been linked together with the PAIR display function.

IN appears only when ST.LINK is set to ON. It determines whether a dynamics processor is patched into just the left/odd channel (L), right/even channel (R), or both (BOTH).

Note: *The DYNAMICS, KEY IN, ST.LINK, and IN parameters are not stored in the dynamics programs. These are individual channel (or stereo pair) parameters and are stored in the scene memories.*

Dynamics Processor Meters

The amount of processor gain reduction (GR) and the output signal levels are metered on the DYNAMICS display function, as shown below:

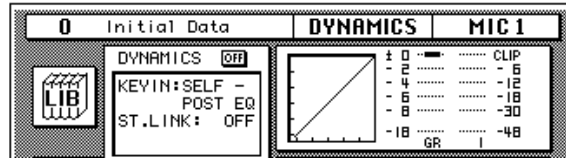

Gain reduction is the amount by which a signal's level is reduced. The output signal levels are conventional level meters which work from bottom-to-top. The GR level meter is inverted and works from top-to-bottom.

For compression, expansion, companding, and ducking, the GR meter operates when the processor is active, that is when it has been triggered by the KEY IN signal, and it shows the amount of signal level reduction.

For a gate, the processor is active when the input signal is below the threshold. So the GR meter operates when the input signal is below the threshold and also when there is no input signal.

Dynamics Graph

The dynamics graph gives you a visual indication of how the parameters of the dynamics processor will effect the signal as it passes through. The horizontal axis of the graph indicates the input signal. The vertical axis indicates the output signal:

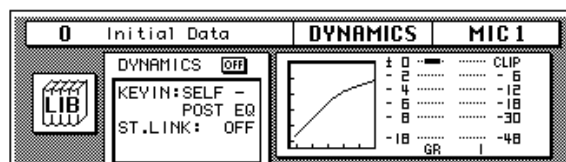

When the dynamics graph is a straight line at 45° from the bottom left corner of the graph, it indicates that the dynamics processor will have no effect on the input signal.

KEY IN and LINK Indicators

The channel KEY IN settings and LINK settings are shown below.

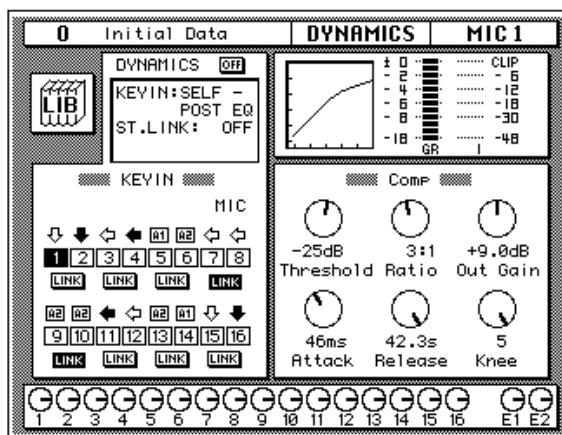

The settings can be changed with the CURSOR buttons, and the encoder wheel, or the [ENTER] button. The following table shows the meaning of the KEY IN icons:

Icon	Meaning
	SELF - POST EQ - the trigger is taken from the current channel after the equalization.
	SELF - PRE EQ - the trigger is taken from the current channel before equalization.
	LEFT - POST EQ - the trigger is taken from the left channel after the equalization.
	LEFT - PRE EQ - the trigger is taken from the left channel before equalization.
	AUX 1 - the trigger is taken from the first auxiliary channel.
	AUX 2 - the trigger is taken from the second auxiliary channel.

The KEY IN icons duplicate the KEY IN prompt, giving you a faster visual indication of the channel status. When the cursor is on a KEY IN icon, press the [ENTER] button to select that channel. The only way you can select the output buses 1 through 8 is with this method.

The LINK icons duplicate the ST.LINK prompt, giving you a faster visual indication of the channel status.

Dynamics Library

1. Press the (DYNAMICS) button again.



The DYNAMICS Library display function appears.

The Dynamics Library is used to access and store dynamics programs. There are 40 preset programs (1 to 40) for you to recall and 88 user programs (41 to 128 plus UNDO) for you to store your own dynamics programs.

You can access this screen from the DYNAMICS display function by selecting the LIB icon with the CURSOR buttons and pressing the [ENTER] button.

Display Screen

Shown below is the DYNAMICS Library display screen:

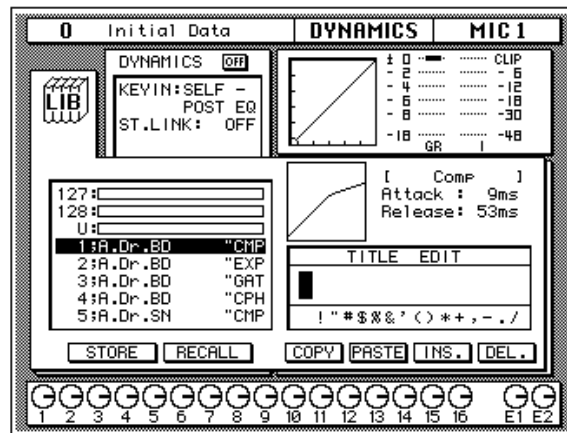

Recalling Dynamics Programs

1. Select a channel using the (SEL) buttons.
2. Use the CURSOR buttons to select the RECALL icon and rotate the encoder wheel to select a dynamics program .
3. Press the (ENTER) button. The dynamics program is recalled.

Storing Dynamics Programs

1. Use the CURSOR buttons to select the STORE icon and select a dynamics program with the encoder wheel.
2. Use the CURSOR buttons and encoder wheel to name the program.
3. Press the (ENTER) button. The 02R pops up a confirmation request.
4. Select EXECUTE and press the (ENTER) button. The dynamics program is stored.

The top of the display shows the Dynamics library icon, the main control prompts, the dynamics graph, and the gain reduction meter plus a level meter for the currently selected channel pair. This will be the curve that was seen in the previous DYNAMICS display screen.

The middle of the display shows a scrolling list of dynamics programs. The name of the dynamics program under the cursor is highlighted. When the cursor is on the STORE, RECALL, COPY, or PASTE control icons, the encoder wheel is used to scroll through the program list. A small diagram of the dynamics graph of the highlighted program is shown to the right along with its vital statistics, such as Attack, Hold, Decay, and so forth.

Beside the list of dynamics programs is the TITLE EDIT field. The CURSOR buttons are used to select the character, and the encoder wheel is used to change its value.

The bottom of the display contains the control button icons. Use the CURSOR buttons to select from the STORE, RECALL, COPY, PASTE, INS., and DEL. icons.

Exiting the Library

Selecting the LIB icon and pressing the [ENTER] button switches back to the DYNAMICS display function. You can also press the [DYNAMICS] button again.

Control Icons

- **STORE** – This icon is used to store the current program to the library. Select the icon with the CURSOR buttons. Use the encoder wheel to select a program and press the [ENTER] button. The 02R will display a popup confirmation request message asking if you want to store your settings in the selected program. The popup has two control icons: “CANCEL” and “EXECUTE”.

Note: *You can customize your 02R to prevent the confirmation popup from appearing during the STORE operation. See “Preferences” on page 162 of the User’s Guide for more information.*

CANCEL is the default. To cancel the STORE operation, either press the [ENTER] button or wait about 10 seconds – the STORE operation will be automatically cancelled.

To store your settings, use the CURSOR buttons to select the “EXECUTE” control icon and press the [ENTER] button. The program is stored.

When you confirm a STORE operation, any existing data in the selected program location will be overwritten.

YOU SHOULD ALWAYS BE CAREFUL WHEN THE 02R DISPLAYS ITS CONFIRMATION POPUP MESSAGE!

- **RECALL** – This icon is used to recall a program from the library. Select the icon with the CURSOR buttons. Use the encoder wheel to select a program and press the [ENTER] button. The recalled program is now the current program.
- **COPY** – This icon is used to copy the name of a library program. Select the icon with the CURSOR buttons. Use the encoder wheel to select a program and press the [ENTER] button. The program name is copied into an edit buffer.
- **PASTE** – This icon is used to paste a program name previously selected with the COPY operation into the TITLE EDIT box. Select the icon with the CURSOR buttons and press the [ENTER] button. The program name is pasted from the edit buffer into the TITLE EDIT box for subsequent editing.
- **INS.** – This icon is used to insert blank characters into the TITLE EDIT box at the current cursor location. Select the icon with the CURSOR buttons and press the [ENTER] button.
- **DEL.** – This icon is used to delete characters from the TITLE EDIT box at the current cursor location. Select the icon with the CURSOR buttons and press the [ENTER] button.

UNDO Operation

When the 02R stores or recalls a program, the previous settings are always preserved in the UNDO buffer. If you discover you have made a mistake, you can always recall the UNDO buffer (displayed as "U:" in the scrolling list of programs). Use the CURSOR buttons to select the RECALL icon, then rotate the encoder wheel until the UNDO buffer is the current program, and press the [ENTER] button. The previous settings are restored.

Program Name

Dynamics program names can be up to 16 characters in length and can contain any of the following characters:

	!	"	#	\$	%	&	'	()	*	+	,	-	.	/
0	1	2	3	4	5	6	7	8	9	:	;	<	=	>	?
@	A	B	C	D	E	F	G	H	I	J	K	L	M	N	O
P	Q	R	S	T	U	V	W	X	Y	Z	[\]	^	_
`	a	b	c	d	e	f	g	h	i	j	k	l	m	n	o
p	q	r	s	t	u	v	w	x	y	z	{		}	~	

Preset Dynamics Program Parameters

The “Release”, “Hold”, and “Decay” values shown in the following table are valid when the 02R is set at a sampling frequency of 44.1kHz.

No.	Name	Type	Parameter	Value	Description	
1	A.Dr.BD	"CMP	Compressor	Threshold (dB)	-24	Compressor that gives the best results with an acoustic bass drum.
				Ratio (:1)	3	
				Attack (ms)	9	
				Outgain (dB)	5.5	
				Release (ms)	58	
2	A.Dr.BD	"EXP	Expander	Threshold (dB)	-23	Expander for the same purpose as program 1.
				Ratio (:1)	1.7	
				Attack (ms)	1	
				Outgain (dB)	3.5	
				Release (ms)	70	
3	A.Dr.BD	"GAT	Gate	Threshold (dB)	-11	Gate for the same purpose as program 1.
				Range (dB)	-53	
				Attack (ms)	0	
				Decay (ms)	400	
4	A.Dr.BD	"CPH	CompanderH	Threshold (dB)	-11	Hard compander for the same purpose as program 1.
				Ratio (:1)	3.5	
				Attack (ms)	1	
				Outgain (dB)	-1.5	
				Release (ms)	192	
5	A.Dr.SN	"CMP	Compressor	Threshold (dB)	-17	Compressor that gives the best results with an acoustic snare drum.
				Ratio (:1)	2.5	
				Attack (ms)	8	
				Outgain (dB)	3.5	
				Release (ms)	12	
6	A.Dr.SN	"EXP	Expander	Threshold (dB)	-23	Expander for the same purpose as program 5.
				Ratio (:1)	2	
				Attack (ms)	0	
				Outgain (dB)	0.5	
				Release (ms)	151	

No.	Name	Type	Parameter	Value	Description	
7	A.Dr.SN	"GAT	Gate	Threshold (dB)	-8	Gate for the same purpose as program 5.
				Range (dB)	-23	
				Attack (ms)	1	
				Hold (ms)	0.63	
				Decay (ms)	238	
8	A.Dr.SN	"CPS	CompanderS	Threshold (dB)	-8	Soft compander for the same purpose as program 5.
				Ratio (:1)	1.7	
				Attack (ms)	11	
				Outgain (dB)	0.0	
				Release (ms)	128	
9	A.Dr.Tom	"EXP	Expander	Threshold (dB)	-20	Expander for acoustic toms automatically reduces the volume when the toms are not played, helping to differentiate the bass and snare drums clearly.
				Ratio (:1)	2	
				Attack (ms)	2	
				Outgain (dB)	5.0	
				Knee	2	
10	A.Dr.OverTop	"CPS	CompanderS	Threshold (dB)	-24	Soft compander to emphasize the attack and ambience of cymbals using overhead microphones. It automatically reduces the volume when the cymbals are not played, helping differentiate the bass and snare drums clearly.
				Ratio (:1)	2	
				Attack (ms)	38	
				Outgain (dB)	-3.5	
				Release (ms)	842	
11	E.B.finger	"CMP	Compressor	Threshold (dB)	-12	Compressor to equalize the attack and volume level of a finger-picked electric bass guitar.
				Ratio (:1)	2	
				Attack (ms)	15	
				Outgain (dB)	4.5	
				Release (ms)	470	
12	E.B.slapp	"CMP	Compressor	Threshold (dB)	-12	Compressor to equalize the attack and volume level of a slap electric bass guitar
				Ratio (:1)	1.7	
				Attack (ms)	6	
				Outgain (dB)	4.0	
				Release (ms)	133	
13	Syn.Bass	"CMP	Compressor	Threshold (dB)	-10	Compressor to adjust and/or emphasize the level of a synth bass.
				Ratio (:1)	3.5	
				Attack (ms)	9	
				Outgain (dB)	3.0	
				Release (ms)	250	

No.	Name	Type	Parameter	Value	Description	
14	Piano1	"CMP	Compressor	Threshold (dB)	-9	Compressor to brighten the tonal color of a piano.
				Ratio (:1)	2.5	
				Attack (ms)	17	
				Outgain (dB)	1.0	
				Knee	hard	
				Release (ms)	238	
15	Piano2	"CMP	Compressor	Threshold (dB)	-18	A variation on program 14, adjusting the attack and entire level using a deeper threshold.
				Ratio (:1)	3.5	
				Attack (ms)	7	
				Outgain (dB)	6.0	
				Knee	2	
				Release (ms)	174	
16	E.Guitar	"CMP	Compressor	Threshold (dB)	-8	Compressor for backing performances, such as electric rhythm guitar playing chords or arpeggios.
				Ratio (:1)	3.5	
				Attack (ms)	7	
				Outgain (dB)	2.5	
				Knee	4	
				Release (ms)	261	
17	A.Guitar	"CMP	Compressor	Threshold (dB)	-10	A variation on program 16, intended for acoustic guitar playing rhythm chords or arpeggios.
				Ratio (:1)	2.5	
				Attack (ms)	5	
				Outgain (dB)	1.5	
				Knee	2	
				Release (ms)	238	
18	Strings1	"CMP	Compressor	Threshold (dB)	-11	Compressor for string instruments. This program was intended for violins.
				Ratio (:1)	2	
				Attack (ms)	33	
				Outgain (dB)	1.5	
				Knee	2	
				Release (ms)	749	
19	Strings2	"CMP	Compressor	Threshold (dB)	-12	A variation on program 18, intended for violas or cellos.
				Ratio (:1)	1.5	
				Attack (ms)	93	
				Outgain (dB)	1.5	
				Knee	4	
				Release (ms)	1.35 S	
20	Strings3	"CMP	Compressor	Threshold (dB)	-17	A variation on program 18, intended for string instruments with a very low range, such as cellos or contrabass.
				Ratio (:1)	1.5	
				Attack (ms)	76	
				Outgain (dB)	2.5	
				Knee	2	
				Release (ms)	186	

No.	Name	Type	Parameter	Value	Description	
21	BrassSection	"CMP	Compressor	Threshold (dB)	-18	Compressor intended for brass sounds with fast and strong attack.
				Ratio (:1)	1.7	
				Attack (ms)	18	
				Outgain (dB)	4.0	
				Knee	1	
				Release (ms)	226	
22	Syn.Pad	"CMP	Compressor	Threshold (dB)	-13	Compressor for synth pad, intended to prevent diffusion of the sound.
				Ratio (:1)	2	
				Attack (ms)	58	
				Outgain (dB)	2.0	
				Knee	1	
				Release (ms)	238	
23	SamplingPerc	"CPS	CompanderS	Threshold (dB)	-18	Compressor for sampled sounds to boost them to be as powerful and clear as the acoustic sounds. This program is for percussion sounds.
				Ratio (:1)	1.7	
				Attack (ms)	8	
				Outgain (dB)	-2.5	
				Width (dB)	18	
				Release (ms)	238	
24	Sampling BD	"CMP	Compressor	Threshold (dB)	-14	A variation on program 23, intended for sampled bass drum sounds.
				Ratio (:1)	2	
				Attack (ms)	2	
				Outgain (dB)	3.5	
				Knee	4	
				Release (ms)	35	
25	Sampling SN	"CMP	Compressor	Threshold (dB)	-18	A variation on program 23, intended for sampled snare drum sounds.
				Ratio (:1)	4	
				Attack (ms)	8	
				Outgain (dB)	8.0	
				Knee	hard	
				Release (ms)	354	
26	Hip Comp	"CPS	CompanderS	Threshold (dB)	-23	A variation on program 23, intended for sampled sounds for loops.
				Ratio (:1)	20	
				Attack (ms)	15	
				Outgain (dB)	0.0	
				Width (dB)	15	
				Release (ms)	163	
27	Solo Vocal1	"CMP	Compressor	Threshold (dB)	-20	Compressor suited for a solo vocal source.
				Ratio (:1)	2.5	
				Attack (ms)	31	
				Outgain (dB)	2.0	
				Knee	1	
				Release (ms)	342	

No.	Name	Type	Parameter	Value	Description	
28	Solo Vocal2	"CMP	Compressor	Threshold (dB)	-8	A variation on program 27.
				Ratio (:1)	2.5	
				Attack (ms)	26	
				Outgain (dB)	1.5	
				Knee	3	
				Release (ms)	331	
29	Chorus	"CMP	Compressor	Threshold (dB)	-9	A variation on program 27, intended for chorus vocals.
				Ratio (:1)	1.7	
				Attack (ms)	39	
				Outgain (dB)	2.5	
				Knee	2	
				Release (ms)	226	
30	Compander(H)	"CPH	CompanderH	Threshold (dB)	-10	A template for the hard knee compander program.
				Ratio (:1)	3.5	
				Attack (ms)	1	
				Outgain (dB)	0.0	
				Width (dB)	6	
				Release (ms)	250	
31	Compander(S)	"CPS	CompanderS	Threshold (dB)	-8	A template for the soft knee compander program.
				Ratio (:1)	4	
				Attack (ms)	25	
				Outgain (dB)	0.0	
				Width (dB)	24	
				Release (ms)	180	
32	Click Erase	"EXP	Expander	Threshold (dB)	-33	Expander to remove click track sounds that may bleed out of the monitor headphones the musicians are using.
				Ratio (:1)	2	
				Attack (ms)	1	
				Outgain (dB)	2.0	
				Knee	2	
				Release (ms)	284	
33	Announcer	"CPH	CompanderH	Threshold (dB)	-14	Hard compander reduces the level during the interval between the words, making the voice sound even.
				Ratio (:1)	2.5	
				Attack (ms)	1	
				Outgain (dB)	-2.5	
				Width (dB)	18	
				Release (ms)	180	
34	Easy Gate	"GAT	Gate	Threshold (dB)	-26	A template for the gate program.
				Range (dB)	-56	
				Attack (ms)	0	
				Hold (ms)	2.56	
				Decay (ms)	331	

No.	Name	Type	Parameter	Value	Description
35	BGM Ducking "DUK	Ducking	Threshold (dB)	-19	Ducking background music for voiceovers, typically keyed from the announcer's channel.
			Range (dB)	-22	
			Attack (ms)	93	
			Hold (ms)	1.20 S	
			Decay (ms)	6.32 S	
36	Limiter1 "CMP	CompanderS	Threshold (dB)	-8	A template for a limiter using the soft compander program. This program has a slow release.
			Ratio (:1)	4	
			Attack (ms)	25	
			Outgain (dB)	0.0	
			Width (dB)	24	
			Release (ms)	180	
37	Limiter2 "CMP	Compressor	Threshold (dB)	0	A template for a limiter using the compressor program. This program is a PEAK STOP type.
			Ratio (:1)	∞	
			Attack (ms)	0	
			Outgain (dB)	0.0	
			Knee	hard	
			Release (ms)	319	
38	Total Comp1 "CMP	Compressor	Threshold (dB)	-8	Compressor intended to reduce the overall volume level. Use for the stereo out during mixdown. It is also interesting on stereo input signals.
			Ratio (:1)	2.5	
			Attack (ms)	60	
			Outgain (dB)	0.0	
			Knee	2	
			Release (ms)	1.12 S	
39	Total Comp2 "CMP	Compressor	Threshold (dB)	-18	A variation of program 38. It has a harder compression ratio.
			Ratio (:1)	3.5	
			Attack (ms)	94	
			Outgain (dB)	2.5	
			Knee	hard	
			Release (ms)	447	
40	Total Comp3 "CMP	Compressor	Threshold (dB)	-16	A variation of program 38. It has an extreme compression ratio, almost a limiter in effect.
			Ratio (:1)	6	
			Attack (ms)	11	
			Outgain (dB)	6.0	
			Knee	1	
			Release (ms)	180	

6

Auxiliary Channels

In this chapter...

About the 02R Auxiliaries	84
The AUX Buttons.....	85
Stereo Input Channels.....	87
AUX [ON] Button	87
AUX Pre or Post.....	87
Monitor Mix	88

About the 02R Auxiliaries

The Digital Recording Console 02R has eight auxiliary send channels: AUX1, AUX2, AUX3, AUX4, AUX5, AUX6, AUX7, and AUX8. The auxiliary sends can be configured pre-fader or post-fader.

AUX7 and AUX8 are used to feed the internal effects processors: Effect1 and Effect2. EFF1 RTN and EFF2 RTN are used to return the processed signals. Refer to “Internal Effects” on page 89 of the *User’s Guide* for further details.

The other auxiliary sends can be used to feed external effects processors, foldback amplifiers, or multitrack recording equipment. When a send is used to feed an external effects processor, the processed signal can be returned via one of the stereo input channels or an unused monophonic input channel.

There are two different ways to access the auxiliary send channels:

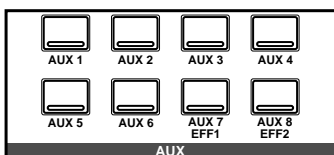

DISPLAY ACCESS – AUX buttons

These buttons access the Display Functions that set the auxiliary send levels for the recording console.

- The [AUX 1] to [AUX 6] buttons set the auxiliary send levels to the corresponding auxiliary bus. You can also select whether to send the signal pre or post fader.
- The [AUX 7] and [AUX 8] buttons also set the send levels to the corresponding auxiliary bus and can select pre or post fader. However, these two sends are routed to the internal effects unit. Therefore, the buttons also allow you to select and set the effects parameters.

The display shows the levels for all the channels in two screens: the first screen shows the MIC/LINE channels, and the second shows the TAPE and EFF channels.

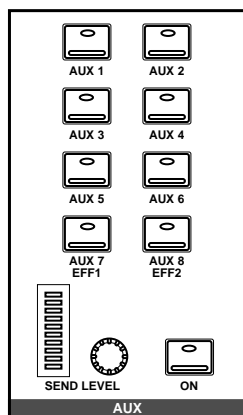

SELECTED CHANNEL – AUX controls

These buttons and controls set the auxiliary send levels for the currently selected channel.

- The [AUX 1] to [AUX 8] buttons allow you to select the auxiliary buses you want to send the selected channel signal to.
- The SEND LEVEL rotary encoder is used to set the level – indicated by the adjacent LED bargraph.
- The [ON] button is used to turn the send on or off. It allows you to make easy A-B comparisons.

The AUX Buttons

1. Press the (AUX 1) button.



The AUX 1 display function appears.

2. Select a channel using the (SEL) buttons or the CURSOR buttons.
3. To turn the send on, press the (ON) button in the AUX group of the SELECTED CHANNEL controls. The LED inset in the button illuminates.

Note: The [ON] button is the only way to turn the send on or off.

4. To change the aux send from pre to post-fader, press the (ENTER) button. The icon is highlighted in reverse video and the text changes to POST when the signal is post fader.

Note: Pre or post fader selection can only be made from the display function.

5. To change the signal level, adjust the corresponding fader or rotary encoder until the desired value is obtained.

Note: This example only shows AUX 1. The other channels are identical in function.

The AUX functions for AUX 1 through AUX 6 set the channel send levels to each of the auxiliary buses. With this function, you can select an auxiliary bus and then set the levels of a group of input channels simultaneously. You can also select whether to send the signal pre or post fader.

Fader Status

When the AUX functions are selected, the faders change from channel level controls to auxiliary send level controls. The faders automatically move to the corresponding auxiliary send levels.

Note: Avoid blocking the fader movements when the faders relocate to their auxiliary send positions by placing objects on the 02R. It is possible to damage the faders.

The AUX LED of the FADER STATUS indicator will illuminate to indicate the fader status. The number indicator corresponding to current the AUX button is also illuminated:

FADER STATUS							
○	INPUT						
▽	AUX						
1	2	3	4				
5	6	7	8				

The send levels for the input channels are operated by their faders. Press the [FLIP] button, and the send levels for the tape return channels can be operated by the faders. You can also use the rotary encoders to set the tape return levels. The effect return levels can only be adjusted with the rotary encoders.

Note: When you press the [FLIP] button, the faders will automatically move to the levels of the opposite channels (from input levels to tape return levels). Avoid blocking the fader movements when the faders reposition by placing objects on the 02R. It is possible to damage the faders.

SELECTED CHANNEL Controls

You can use the SEND LEVEL encoder in the AUX group of the SELECTED CHANNEL controls to set the signal level to the auxiliary bus. The method of working with these controls is different than working with the DISPLAY ACCESS – AUX buttons.

Select a channel with the [SEL] buttons. Select the auxiliary bus with the [AUX1] through [AUX8/EFF2] buttons. Turn the send on or off with the [ON] button. Adjust the send level with the SEND LEVEL encoder.

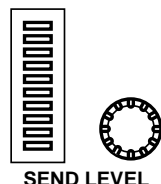

Display Screens

There are two screens in the AUX display functions. Shown below is the first – MIC/LINE 1 through 16 and LINE 17/18 through 23/24:

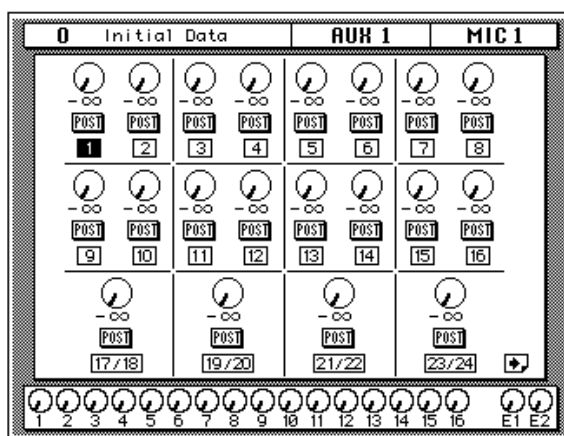

Select this screen by pressing a SEL button for one of the MIC/LINE channels.

Shown below is the second screen – TAPE 1 through 16, and EFF1 and EFF2:

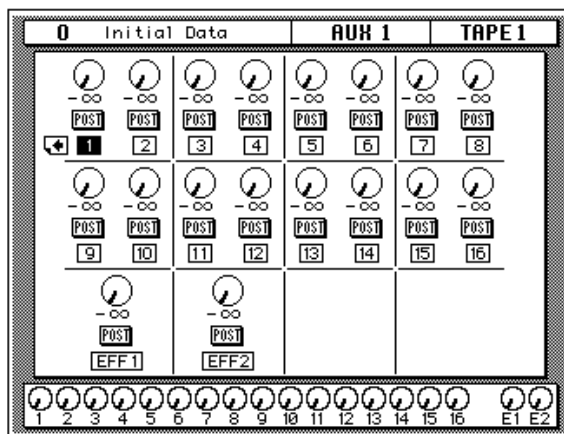

Select this screen by pressing a SEL button for the tape or effect returns channels.

Stereo Input Channels

Input channels 1 through 16 handle only a single signal. The stereo input channels 17 through 24, are paired together and handle two signals: left and right. Before feeding a stereo input signal to the auxiliary level controls, the left and right signals are summed to form a mono L+R mix.

AUX (ON) Button

The auxiliary sends can be turned on or off for quick A-B comparisons by using the [ON] button in the AUX group of the SELECTED CHANNEL controls. When the send for a channel is turned off, the send level icon for that channel continues to show the current level setting for the channel, but the text underneath the icon switches to "OFF" giving you a quick visual indicator of the channel send status:

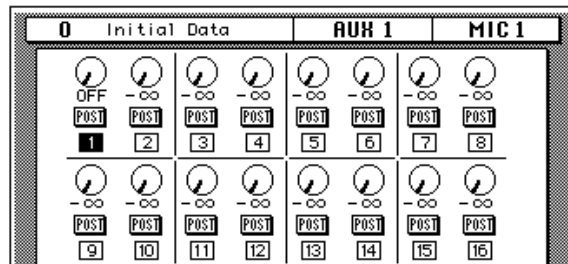

The LED inset in the [ON] button is illuminated when the send for a channel is turned on.

Note: The [ON] button of the SELECTED CHANNEL – AUX controls is the only way to turn the channel send on or off.

AUX Pre or Post

The auxiliary sends can be configured as pre-fader or post-fader. This setting can be changed by selecting a channel with a [SEL] button or the CURSOR buttons and pressing the [ENTER] button for that channel.

If you select a channel with a [SEL] button or the CURSOR buttons and double-click the [ENTER] button, all channels will be set to the same pre-fader or post-fader status as the selected channel.

POST – the auxiliary send signal is sourced after the channel fader. This means that the signal is controlled by the channel fader as well as the send level. In order to send a signal to the auxiliary bus, you must have that fader raised as well. This enables the channel-to-mix and channel-to-effects signal levels to be controlled together, with the former supplying the dry, unaffected signal and the latter supplying the wet, affected signal. This is useful when, for example, you fade-out a channel, since the channel-to-mix and channel-to-effects signals are reduced together.

PRE – the auxiliary send signal is sourced before the channel fader. The send signal is unaffected by the channel fader and its level can be set independently.

Note: *Pre or post-fader selection can only be made from the corresponding display function.*

Monitor Mix

1. Press the (AUX 5) button.



The AUX 5 display function appears.

2. Select a channel using the (SEL) buttons or the CURSOR buttons.
3. Set the send on and set it to pre/post fader as detailed previously.
4. Press the (AUX 5) button of the STUDIO buttons group.
5. Adjust the STUDIO LEVEL control, then adjust the channel level using the appropriate faders or rotary encoders.

The Digital Recording Console 02R has two different monitoring outputs – the control room outputs (including the PHONES output) and the studio outputs.

Often during a multitrack recording session, what you want to listen to in the control room is very different from what the musicians need in the studio. For example, while recording a rhythm section, the bass player and the drummer may want to hear the kick drum at a much higher volume than you need in the control room.

To cater to this requirement, the 02R allows you to create a monitor mix using either AUX5 or AUX6.

Use the STUDIO buttons to select the monitor signal sent to the studio monitor system. You can monitor the signal on the stereo bus with the [ST] button or select the auxiliary channels (AUX5 or AUX6). You can select any combination of the [ST], [AUX5], and [AUX6] buttons:

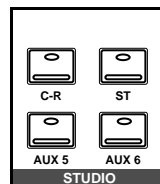

You can also use the [C-R] button to send the signal being monitored in the control room to the studio outputs.

Use the CONTROL ROOM buttons to select the monitor signal sent to the control room monitor system. See “Monitor Selector Switches” on page 29 and “Monitor Level Controls” on page 30 of the *User’s Guide* for more details.

7

Internal Effects

In this chapter...

About Effects	90
Preset Effects Programs	91
AUX 7 and AUX 8	92
Effects	94
Effects Library	95
Preset Effects Program Parameters	98

About Effects

The Digital Recording Console 02R features two internal multi-effects stereo processors: Effect1 and Effect2. These are fed by AUX7 and AUX8, and the processed signals are returned via EFF1 RTN and EFF2 RTN, respectively. The auxiliary sends can be configured pre-fader or post-fader. Effects can be applied to input channels, the tape return channels, or the stereo output channel. Effects are organized into programs. There are 40 preset effects programs (1 through 40) and 88user effects programs (41 through 128 plus an UNDO buffer) for you to store your own settings.

There are two different ways to access the internal effects unit send channels:

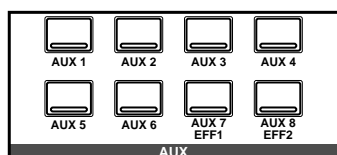

DISPLAY ACCESS – AUX buttons

These buttons access the Display Functions that set the auxiliary send levels for the recording console.

The [AUX 7] and [AUX 8] buttons are routed to the internal effects unit. Use them to set the send levels to the corresponding effects unit and select pre or post fader. These buttons also allow you to select and set the effects parameters.

The display shows the send levels for all the channels in two screens: the first screen shows the MIC/LINE channels and the second shows the TAPE and EFF channels. There is also two other screens – the third allows you to set the effects parameters, and the fourth allows you to access the effects library.

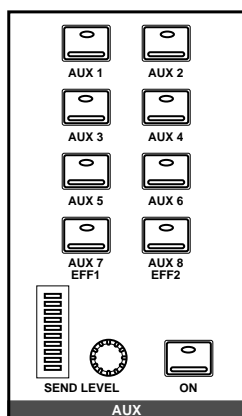

SELECTED CHANNEL – AUX controls

These buttons and controls set the auxiliary send levels for the currently selected channel.

- The [AUX 1] to [AUX 8] buttons allow you to select the auxiliary buses you want to send the selected channel signal to.
- The SEND LEVEL rotary encoder is used to set the level – indicated by the adjacent LED bargraph.
- The [ON] button is used to turn the send on or off. It allows you to make easy A-B comparisons.

Preset Effects Programs

These are the preset effects programs:

No	Program Name	No	Program Name
1	REVERB HALL1	21	REVERSE GATE
2	REVERB HALL2	22	DELAY->EARLY REF
3	REVERB ROOM1	23	DELAY L-C-R 1
4	REVERB ROOM2	24	DELAY L-C-R 2
5	REVERB STAGE	25	CHORUS->DLY LCR
6	REVERB PLATE	26	MONODLY->CHORUS
7	REV AMBIENCE1	27	STEREO INI.DLY ECHO
8	REV AMBIENCE2	28	ECHO
9	REV LIVE ROOM1	29	CROSS ECHO
10	REV LIVE ROOM2	30	CROSS DELAY
11	REVERB VOCAL1	31	CHORUS1
12	REVERB VOCAL2	32	CHORUS2
13	REV SN.ROOM	33	BROAD CHORUS
14	REV SN.PLATE	34	FLANGE
15	CHORUS->REVERB	35	SYMPHONIC
16	FLANGE->REVERB1	36	TREMOLO
17	FLANGE->REVERB2	37	AUTO PAN
18	EARLY REF.1	38	PHASING
19	EARLY REF.2	39	ST.PITCH CHANGE
20	GATE REVERB	40	VOCAL DOUBLER

AUX 7 and AUX 8

1. Press the (AUX 7) button.



The AUX 7 display function appears.

2. Select a channel using the (SEL) buttons or the cursor buttons.
3. To turn the send on, press the (ON) button in the AUX group of the SELECTED CHANNEL controls. The LED inset in the button illuminates.

Note: The [ON] button is the only way to turn the send on or off.

4. To change the aux send from pre to post-fader, press the (ENTER) button. The icon is highlighted in reverse video and the text changes to POST when the signal is post fader.

Note: Pre or post fader selection can only be made from the display function.

5. To change the signal level, adjust the fader or rotary encoder until the desired value is obtained.

Note: AUX 7 and AUX 8 are identical.

The AUX functions for AUX 7 and AUX 8 set the channel send levels to either of these effects buses. Similar to the functions for AUX 1 through AUX 6, you select an effect bus and then set the levels of a group of input channels. You can also select whether to send the signals pre or post fader.

Fader Status

When the AUX functions are selected, the faders change from channel level controls to auxiliary send level controls. The faders automatically move to the corresponding auxiliary send levels.

Note: Avoid blocking the fader movements when the faders relocate to their auxiliary send positions by placing objects on the 02R. It is possible to damage the faders.

The AUX LED of the FADER STATUS indicator will illuminate to indicate the fader status. The number indicator corresponding to current the AUX button is also illuminated:

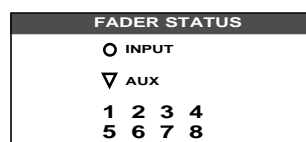

The send levels for the input channels are operated by their faders. Press the [FLIP] button, and the send levels for the tape return channels can be operated by the faders. You can also use the rotary encoders to set the tape return levels. The effect return levels can only be adjusted with the rotary encoders.

Note: When you press the [FLIP] button, the faders will automatically move to the levels of the opposite channels (from input levels to tape return levels). Avoid blocking the fader movements when the faders reposition by placing objects on the 02R. It is possible to damage the faders.

SELECTED CHANNEL Controls

You can use the SEND LEVEL encoder in the AUX group of the SELECTED CHANNEL controls to set the signal level to the auxiliary bus. The method of working with these controls is different than working with the DISPLAY ACCESS – AUX buttons.

Select a channel with the [SEL] buttons. Select the auxiliary bus with the [AUX1] through [AUX8/EFF2] buttons. Turn the send on or off with the [ON] button. Adjust the send level with the SEND LEVEL encoder.

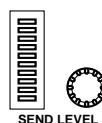

Display Screens

There are four screens in the AUX display functions. Two screens access the channels to send to the effects buses, the other two screens allow you to select and set-up the effects.

Shown below is the first – MIC/LINE 1 through 16 and LINE 17/18 through 23/24:

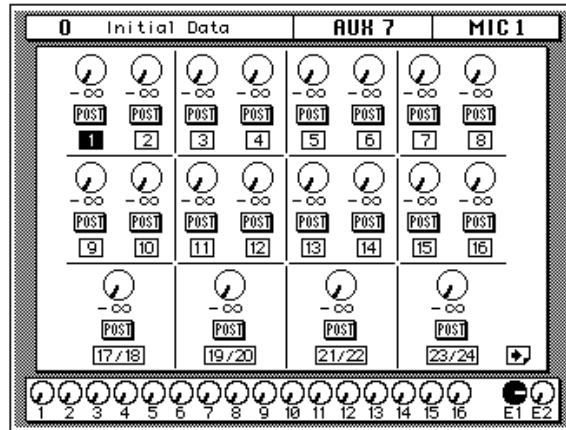

Select this screen by pressing a SEL button for one of the MIC/LINE channels.

Shown below is the second screen – TAPE 1 through 16, and EFF1 or EFF2:

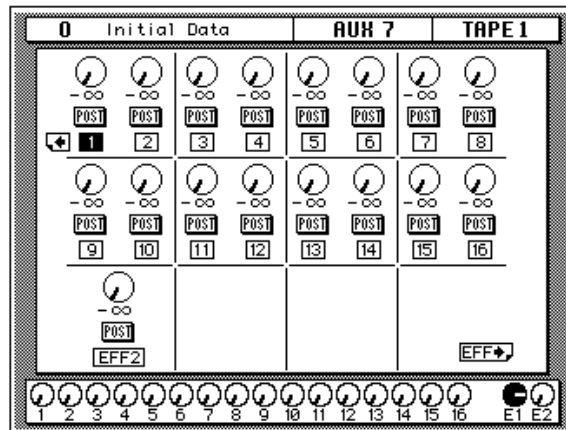

Select this screen by pressing a SEL button for the tape or effect returns channels.

Note: The AUX functions for AUX 7 and AUX 8 are restricted in their assignments to the effects buses. AUX 7 can only route to Effect2 and AUX 8 can only route to Effect1.

Effects

1. Press the (AUX 7) button again.



The EFFECT display function appears.

2. Select a control icon using the cursor buttons.
3. To change the value of the selected item, rotate the encoder wheel until the desired value is shown.

The Digital Recording Console 02R is equipped with two internal multi-effects stereo processors. These processors have a startling range of special effects available to apply to your mix – shimmering reverbs, clean, precise delays, flanging and chorus, and a myriad of other effects are available.

Display Screen

Shown below is the Effect Edit display screen:

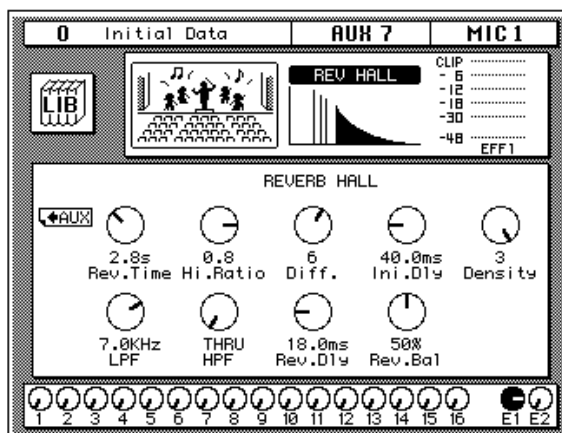

The top of the display shows the Effects library icon, an effects curve or icon (which changes depending on the selected effect), and a level meter for the effects return stereo pair.

The bottom of the display shows the controls for adjusting the parameters for the currently selected channel. These control parameters change depending on the selected effects. Use the cursor buttons to select the desired icon and adjust its value with the encoder wheel.

Note: Only one effects program can run on an effects processor. This means that all the channel auxiliary sends that are set to, for example, AUX 7 will be processed by the program that is currently running on Effect Processor 1. The current effect program is stored in scene memory.

Effects Library

1. Press the (AUX 7) button again.



The EFFECT Library display function appears.

The Effects Library is used to access and store effects programs. There are 40 preset effects programs (1 through 40) and 88 user effects programs (41 through 128 plus an UNDO buffer) for you to store your own settings.

You can access this screen from the EFFECT display function by selecting the LIB icon with the CURSOR buttons and pressing the [ENTER] button.

Display Screen

Shown below is the EFFECT Library display screen:

Recalling Effects Programs

1. Use the CURSOR buttons to select the RECALL icon and select an effects program with the encoder wheel.
2. Press the (ENTER) button. The effects program is recalled.

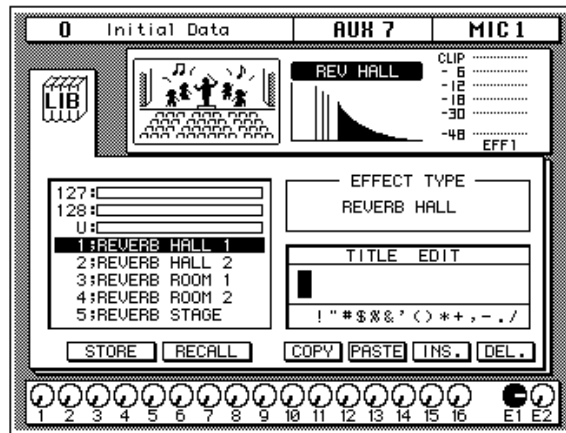

Storing Effects Programs

1. Use the CURSOR buttons to select the STORE icon and select an effects program with the encoder wheel.
2. Use the CURSOR buttons and encoder wheel to name the program.
3. Press the (ENTER) button. The 02R pops up a confirmation request.
4. Select EXECUTE and press the (ENTER) button. The effects program is stored.

The top of the display shows an effects curve or icon (which changes depending on the selected effect), and a level meter for the effects return stereo pair.

The middle of the display shows a scrolling list of effects programs. The name of the effects program under the cursor is highlighted. When the cursor is on the STORE, RECALL, COPY, or PASTE control icons, the encoder wheel is used to scroll through the program list.

Beside the list of effects programs is the EFFECT TYPE field and below that is the TITLE EDIT field. The cursor buttons are used to select the characters in the title, and the encoder wheel is used to change the value.

The bottom of the display contains the control button icons. Use the cursor buttons to select from the STORE, RECALL, COPY, PASTE, INS., and DEL. icons.

Exiting the Library

Selecting the LIB icon and pressing the [ENTER] button switches back to the EFFECT display function.

You can also press the [AUX 7] button again. You may have to press it several times to get to the EFFECT display function.

Control Icons

- **STORE** – This icon is used to store the current program to the library. Select the icon with the CURSOR buttons. Use the encoder wheel to select a program and press the [ENTER] button. The 02R will display a popup confirmation request message asking if you want to store your settings in the selected program. The popup has two control icons: “CANCEL” and “EXECUTE”.

Note: *You can customize your 02R to prevent the confirmation popup from appearing during the STORE operation. See “Preferences” on page 162 of the User’s Guide for more information.*

CANCEL is the default. To cancel the STORE operation, either press the [ENTER] button or wait about 10 seconds – the STORE operation will be automatically cancelled.

To store your settings, use the CURSOR buttons to select the “EXECUTE” control icon and press the [ENTER] button. The program is stored.

When you confirm a STORE operation, any existing data in the selected program location will be overwritten.

YOU SHOULD ALWAYS BE CAREFUL WHEN THE 02R DISPLAYS ITS CONFIRMATION POPUP MESSAGE!

- **RECALL** – This icon is used to recall a program from the library. Select the icon with the CURSOR buttons. Use the encoder wheel to select a program and press the [ENTER] button. The recalled program is now the current program.
 - **COPY** – This icon is used to copy the name of a library program. Select the icon with the CURSOR buttons. Use the encoder wheel to select a program and press the [ENTER] button. The program name is copied into an edit buffer.
 - **PASTE** – This icon is used to paste a program name previously selected with the COPY operation into the TITLE EDIT box. Select the icon with the CURSOR buttons and press the [ENTER] button. The program name is pasted from the edit buffer into the TITLE EDIT box for subsequent editing.
 - **INS.** – This icon is used to insert blank characters into the TITLE EDIT box at the current cursor location. Select the icon with the CURSOR buttons and press the [ENTER] button.
 - **DEL.** – This icon is used to delete characters from the TITLE EDIT box at the current cursor location. Select the icon with the CURSOR buttons and press the [ENTER] button.
-

UNDO Operation

When the 02R stores or recalls a program, the previous settings are always preserved in the UNDO buffer. If you discover you have made a mistake, you can always recall the UNDO buffer (displayed as "U:" in the scrolling list of programs). Use the CURSOR buttons to select the RECALL icon, then rotate the encoder wheel until the UNDO buffer is the current program, and press the [ENTER] button. The previous settings are restored.

Program Name

Effects program names can be up to 16 characters long and can contain any of the following characters:

	!	"	#	\$	%	&	'	()	*	+	,	-	.	/
0	1	2	3	4	5	6	7	8	9	:	;	<	=	>	?
@	A	B	C	D	E	F	G	H	I	J	K	L	M	N	O
P	Q	R	S	T	U	V	W	X	Y	Z	[\]	^	_
`	a	b	c	d	e	f	g	h	i	j	k	l	m	n	o
p	q	r	s	t	u	v	w	x	y	z	{		}	~	

Preset Effects Program Parameters

Program 1 — REVERB HALL1

This simulates the reverberation in a larger concert hall, and adds spread to sounds such as strings and brass.

Parameter	Setting	Range	Description
Rev.Time	2.8s	0.3~30.0s	Reverb time.
Hi.Ratio	0.8	0.1~1.0	High frequency decay ratio.
Diff.	6	0~10	Reverb diffusion.
Ini.Dly	40.0ms	0.1~200.0ms	Initial delay between the direct sound and early reflections.
Density	3	0~3	Average time between reflections.
LPF	7.0kHz	1.0kHz~THRU	Low pass filter cutoff frequency.
HPF	THRU	THRU~8.0kHz	High pass filter cutoff frequency.
Rev.Dly	18.0ms	0.1~85.0ms	Delay between early reflections and reverb.
Rev.Bal	50%	0~100%	Reverb balance. The amount of reverb.

Program 2 — REVERB HALL2

This is a variation of program 1. It emphasizes longer reverberation and spaciousness.

Parameter	Setting	Range	Description
Rev.Time	3.2s	Same as program 1	Same as program 1
Hi.Ratio	0.7		
Diff.	8		
Ini.Dly	38.0ms		
Density	3		
LPF	6.3kHz		
HPF	THRU		
Rev.Dly	17.0ms		
Rev.Bal	50%		

Program 3 — REVERB ROOM1

This simulates reverberation of a room with many reflective wall aspects. It gives a live acoustic feel to drums.

Parameter	Setting	Range	Description
Rev.Time	1.4s	Same as program 1	Same as program 1
Hi.Ratio	0.8		
Diff.	7		
Ini.Dly	5.0ms		
Density	3		
LPF	THRU		
HPF	280Hz		
Rev.Dly	1.0ms		
Rev.Bal	50%		

Program 4 — REVERB ROOM2

This is a variation on program 3.

Parameter	Setting	Range	Description
Rev.Time	1.8s	Same as program 1	Same as program 1
Hi.Ratio	0.6		
Diff.	6		
Ini.Dly	17.0ms		
Density	3		
LPF	9.0kHz		
HPF	80Hz		
Rev.Dly	4.0ms		
Rev.Bal	50%		

Program 5 — REVERB STAGE

This has a slightly brighter effect than the REVERB HALL programs. Applying a small amount of this effect to an entire mix will create the feel of live acoustic environment.

Parameter	Setting	Range	Description
Rev.Time	3.4s	Same as program 1	Same as program 1
Hi.Ratio	0.9		
Diff.	8		
Ini.Dly	45.0ms		
Density	3		
LPF	THRU		
HPF	70Hz		
Rev.Dly	9.0ms		
Rev.Bal	50%		

Program 6 — REVERB PLATE

This simulates an old "steel plate reverb" and is effective on vocals or musical instruments, especially percussion.

Parameter	Setting	Range	Description
Rev.Time	2.4s	Same as program 1	Same as program 1
Hi.Ratio	0.7		
Diff.	8		
Ini.Dly	16.0ms		
Density	3		
LPF	8.0kHz		
HPF	THRU		
Rev.Dly	2.0ms		
Rev.Bal	50%		

Program 7 — REV AMBIENCE1

This creates space (a smaller space than created by the REVERB ROOM programs) around instruments. A small amount of these effects is effective on vocal and chorus, as well as percussion instruments.

Parameter	Setting	Range	Description
Rev.Time	1.2s	Same as program 1	Same as program 1
Hi.Ratio	1.0		
Diff.	8		
Ini.Dly	19.0ms		
Density	3		
LPF	9.0kHz		
HPF	45Hz		
Rev.Dly	4.0ms		
Rev.Bal	50%		

Program 8 — REV AMBIENCE2

This is a variation on program 7.

Parameter	Setting	Range	Description
Rev.Time	0.8s	Same as program 1	Same as program 1
Hi.Ratio	0.6		
Diff.	8		
Ini.Dly	0.1ms		
Density	3		
LPF	THRU		
HPF	56Hz		
Rev.Dly	0.1ms		
Rev.Bal	50%		

Program 9 — REV LIVE ROOM1

This simulates reverberation in much larger rooms.

Parameter	Setting	Range	Description
Rev.Time	2.4s	Same as program 1	Same as program 1
Hi.Ratio	0.8		
Diff.	7		
Ini.Dly	0.1ms		
Density	3		
LPF	7.0kHz		
HPF	THRU		
Rev.Dly	0.1ms		
Rev.Bal	50%		

Program 10 — REV LIVE ROOM2

This is a variation on program 9.

Parameter	Setting	Range	Description
Rev.Time	2.2s	Same as program 1	Same as program 1
Hi.Ratio	0.5		
Diff.	6		
Ini.Dly	12.0ms		
Density	3		
LPF	4.0kHz		
HPF	THRU		
Rev.Dly	3.0ms		
Rev.Bal	50%		

Program 11 — REVERB VOCAL1

This is useful for vocal and chorus.

Parameter	Setting	Range	Description
Rev.Time	1.8s	Same as program 1	Same as program 1
Hi.Ratio	0.4		
Diff.	3		
Ini.Dly	19.0ms		
Density	3		
LPF	6.3kHz		
HPF	110Hz		
Rev.Dly	10.0ms		
Rev.Bal	100%		

Program 12 — REVERB VOCAL2

This has longer reverberation than program 11. This could be suitable for ballads.

Parameter	Setting	Range	Description
Rev.Time	2.8s	Same as program 1	Same as program 1
Hi.Ratio	0.3		
Diff.	6		
Ini.Dly	35.0ms		
Density	2		
LPF	6.3KHz		
HPF	80Hz		
Rev.Dly	30.0ms		
Rev.Bal	100%		

Program 13 — REV SN.ROOM

This is a reverb variation to enhance the sound of a snare drum.

Parameter	Setting	Range	Description
Rev.Time	1.3s	Same as program 1	Same as program 1
Hi.Ratio	0.9		
Diff.	8		
Ini.Dly	26.0ms		
Density	1		
LPF	10.0KHz		
HPF	180Hz		
Rev.Dly	4.0ms		
Rev.Bal	90%		

Program 14 — REV SN.PLATE

This is also for snare drums, similar to program 13.

Parameter	Setting	Range	Description
Rev.Time	1.7s	Same as program 1	Same as program 1
Hi.Ratio	0.9		
Diff.	2		
Ini.Dly	20.0ms		
Density	1		
LPF	11.0KHz		
HPF	140Hz		
Rev.Dly	6.0ms		
Rev.Bal	90%		

Program 15 — CHORUS->REVERB

Stereo chorus followed by reverb. This program will change a dry sound into a warm sound with spread. Use the reverb Depth parameter to adjust the amount of reverberation.

Parameter	Setting	Range	Description
Freq.	4.5Hz	0.1~40.0Hz	Modulation frequency.
Depth	14%	0~100%	Modulation depth. The amount of modulation.
Mod.Dly	7.3ms	0.0~255.0ms	Modulation delay. The delay time before modulation begins.
Rev.Time	1.7s	0.3~30.0s	Reverb time.
Hi.Ratio	0.8	0.1~1.0	High frequency decay ratio.
Diff.	8	0~10	Reverb diffusion.
Ini.Dly	30.0ms	0.1~200.0ms	Initial delay between the direct sound and early reflections.
LPF	12.0KHz	1.0kHz~THRU	Low pass filter cutoff frequency.
HPF	40Hz	THRU~8.0kHz	High pass filter cutoff frequency.
Depth	60%	0~100%	Reverb depth. The amount of reverb.

Program 16 — FLANGE->REVERB1

Flange effect followed by reverb. This effect is more appropriate to emphasize modulation effects than the CHORUS->REVERB program. Use the reverb Depth parameter to adjust the amount of reverberation.

Parameter	Setting	Range	Description
Freq.	2.4Hz	0.1~40.0Hz	Flange modulation frequency.
Depth	68%	0~100%	Flange depth. The amount of modulation.
FB.Gain	+37%	-99 ~ +99%	Feedback gain. The amount of signal returned to the flanger.
Mod.Dly	254.4ms	0.0~255.0ms	Flange delay. The delay time before modulation begins.
Rev.Time	2.6s	0.3~30.0s	Reverb time.
Diff.	8	0~10	Reverb diffusion.
Ini.Dly	10.0ms	0.1~200.0ms	Initial delay between the direct sound and early reflections.
LPF	9.0KHz	1.0kHz~THRU	Low pass filter cutoff frequency.
HPF	45Hz	THRU~8.0kHz	High pass filter cutoff frequency.
Depth	61%	0~100%	Reverb depth. The amount of reverb.

Program 17 — FLANGE->REVERB2

This is a variation of program 16.

Parameter	Setting	Range	Description
Freq.	3.3Hz	Same as program 16	Same as program 16
Depth	9%		
FB.Gain	-63%		
Mod.Dly	0.4ms		
Rev.Time	1.4s		
Diff.	8		
Ini.Dly	9.1ms		
LPF	9.0KHz		
HPF	45Hz		
Depth	56%		

Program 18 — EARLY REF.1

Simulates early reflections only. It can create a wide range of effects , from gate-reverb to ambience effects.

Parameter	Setting	Range	Description
Type	L-Hall	ER type	Choose S-Hall, L-Hall, Random, Reverse, Plate, or Spring.
RoomSize	2.5	0.1~20.0	Time interval between the early reflections.
Liveness	2	0~10	Rate at which reflected sounds fade or decay.
Diff.	8	0~10	Reverb diffusion.
Ini.Dly	23.7ms	0.1~200.0ms	Initial delay between the direct sound and early reflections.
ER Num.	15	1~15	Number of early reflections.
Hi.Ratio	0.8	0.1~1.0	High frequency decay ratio.
FB.Gain	0%	-99 ~ +99%	Feedback gain. The amount of signal returned to the effect.
LPF	10.0kHz	1.0kHz~THRU	Low pass filter cutoff frequency.
HPF	THRU	THRU~8.0kHz	High pass filter cutoff frequency.

Program 19 — EARLY REF.2

This is a variation on program 18. It produces a thicker sound.

Parameter	Setting	Range	Description
Type	S-Hall	Same as program 18	Same as program 18
RoomSize	2.0		
Liveness	7		
Diff.	7		
Ini.Dly	4.8ms		
ER Num.	15		
Hi.Ratio	0.8		
FB.Gain	0%		
LPF	11.0kHz		
HPF	THRU		

Program 20 — GATE REVERB

Simulates a gate reverb effect by using the EARLY REFLECTION program.

Parameter	Setting	Range	Description
Type	Type-B	Type-A, Type-B	Type of reflections
RoomSize	1.9	0.1~20.0	Time interval between the early reflections.
Liveness	8	0~10	Rate at which reflected sounds fade or decay.
Diff.	7	0~10	Reverb diffusion.
Ini.Dly	0.1ms	0.1~200.0ms	Initial delay between the direct sound and early reflections.
ER Num.	15	1~15	Number of early reflections.
Hi.Ratio	0.8	0.1~1.0	High frequency decay ratio.
FB.Gain	0%	-99 ~ +99%	Feedback gain. The amount of signal returned to the effect.
LPF	12.0kHz	1.0kHz~THRU	Low pass filter cutoff frequency.
HPF	THRU	THRU~8.0kHz	High pass filter cutoff frequency.

Program 21 — REVERSE GATE

This is a variation on program 20. It creates somewhat strange, reversed gate reverb sound.

Parameter	Setting	Range	Description
Type	Type-A	Same as program 20	Same as program 20
RoomSize	2.8		
Liveness	8		
Diff.	5		
Ini.Dly	0.1ms		
ER Num.	15		
Hi.Ratio	0.8		
FB.Gain	0%		
LPF	12.0kHz		
HPF	THRU		

Program 22 — DELAY->EARLY REF

This effect creates early reflection sound after a delay.

Parameter	Setting	Range	Description
Delay	256.0ms	0.1~320.0ms	Delay time.
FB.Gain	+43%	-99 ~ +99%	Feedback gain. The amount of signal returned to the effect.
Hi.Ratio	0.3	0.1~1.0	High frequency decay ratio.
Type	Random	ER type	Choose S-Hall, L-Hall, Random, Reverse, Plate, or Spring.
RoomSize	6.8	0.1~20	Time interval between the early reflections.
Liveness	4	0~10	Rate at which reflected sounds fade or decay.
Diff.	3	0~10	Reverb diffusion.
Ini.Dly	8.0ms	0.1~200.0ms	Initial delay between the direct sound and early reflections.
ER Num.	12	1~15	Number of early reflections.
Depth	47%	0~100%	Reverb depth. The amount of reverb.

Program 23 — DELAY L-C-R 1

A three-part delay with independent delay time parameters for left, right, and center.

Parameter	Setting	Range	Description
Dly(L)	125.0ms	0.1~1000.0ms	Left channel delay time.
Dly(R)	250.0ms	0.1~1000.0ms	Right channel delay time.
Dly(C)	500.0ms	0.1~1000.0ms	Centre channel delay time.
Level(C)	+57	-100 ~ +100	Centre delay volume level.
FB.Dly	125.0ms	0.1~1000.0ms	Feedback delay. The delay time before feedback starts.
FB.Gain	+20%	-99 ~ +99%	Feedback gain. The amount of signal returned to the effect.
Hi.Ratio	0.8	0.1~1.0	High frequency decay ratio.
LPF	THRU	1.0kHz~THRU	Low pass filter cutoff frequency.
HPF	THRU	THRU~8.0kHz	High pass filter cutoff frequency.
Ini.Dly	0.1ms	0.1~320.0ms	Initial delay between the direct sound and early reflections.

Program 24 — DELAY L-C-R 2

This is a variation on program 23.

Parameter	Setting	Range	Description
Dly(L)	250.0ms	Same as program 23	Same as program 23
Dly(R)	500.0ms		
Dly(C)	1000.0ms		
Level(C)	+57		
FB.Dly	1000.0ms		
FB.Gain	+17%		
Hi.Ratio	0.8		
LPF	THRU		
HPF	THRU		
Ini.Dly	0.1ms		

Program 25 — CHORUS->DLY LCR

Chorus effect is followed by a three-part delay (L-C-R) with feedback.

Parameter	Setting	Range	Description
Freq.	0.8Hz	0.1~40.0Hz	Chorus modulation frequency.
Depth	24%	0~100%	Chorus depth. The amount of modulation.
Mod.Dly	5.9ms	0.0~255.0ms	Chorus delay. The delay time before modulation starts.
Dly(L)	26.4ms	0.1~1000.0ms	Left channel delay time.
Dly(R)	33.2ms	0.1~1000.0ms	Right channel delay time.
Dly(C)	13.1ms	0.1~1000.0ms	Centre channel delay time.
Level(C)	+60	-100 ~ +100	Centre delay volume level.
FB.Dly	40.5ms	0.1~1000.0ms	Feedback delay. The delay time before feedback starts.
FB.Gain	-48%	-99 ~ +99%	Feedback gain. The amount of signal returned to the effect.
Hi.Ratio	0.1	0.1~1.0	High frequency decay ratio.

Program 26 — MONODLY->CHORUS

Mono feedback delay followed by stereo chorus.

Parameter	Setting	Range	Description
Delay	400.0ms	0.1~1000.0ms	Delay time.
FB.Gain	+32%	-99 ~ +99%	Feedback gain. The amount of signal returned to the effect.
LPF	THRU	1.0kHz~THRU	Low pass filter cutoff frequency.
HPF	THRU	THRU~8.0kHz	High pass filter cutoff frequency.
Freq.	0.4Hz	0.1~40.0Hz	Chorus modulation frequency.
Mod.Dly	0.1ms	0.0~255.0ms	Chorus delay. The delay time before modulation starts.
EQ F	315Hz	160Hz~8.0kHz	Equalizer frequency.
EQ G	0dB	-12 ~ +12dB	Equalizer signal gain.
AM Depth	10%	0~100%	Amplitude modulation depth.
PM Depth	40%	0~100%	Pitch modulation depth.

Program 27 — STEREO INI.DLY ECHO

Stereo feedback delay followed by stereo echo.

Parameter	Setting	Range	Description
FB.D(L)	220.0ms	0.1~360.0ms	Left channel feedback delay time.
FB.G(L)	+40%	-99 ~ +99%	Left channel feedback gain.
FB.D(R)	220.0ms	0.1~360.0ms	Right channel feedback delay time.
FB.G(R)	+40%	-99 ~ +99%	Right channel feedback gain.
Hi.Ratio	0.4	0.1~1.0	High frequency decay ratio.
LPF	THRU	1.0kHz~THRU	Low pass filter cutoff frequency.
HPF	THRU	THRU~8.0kHz	High pass filter cutoff frequency.
Dly(L)	220.0ms	0.1~320.0ms	Left channel delay time.
Dly(R)	110.0ms	0.1~320.0ms	Right channel delay time.

Program 28 — ECHO

This is a common echo effect.

Parameter	Setting	Range	Description
Dly(L)	220.0ms	0.1~500.0ms	Left channel delay time.
FB.G(L)	+44%	-99 ~ +99%	Left channel feedback gain.
Dly(R)	180.0ms	0.1~500.0ms	Right channel delay time.
FB.G(R)	-55%	-99 ~ +99%	Right channel feedback gain.
Hi.Ratio	0.2	0.1~1.0	High frequency decay ratio.
LPF	THRU	1.0kHz~THRU	Low pass filter cutoff frequency.
HPF	THRU	THRU~8.0kHz	High pass filter cutoff frequency.
Ini.Dly	0.1ms	0.1~320.0ms	Initial delay between the direct sound and early reflections.
L->R Bal	0%	0~100%	Feeds left channel signal back to the right channel.
R->L Bal	0%	0~100%	Feeds right channel signal back to the left channel.

Program 29 — CROSS ECHO

The echo feedback signal crosses from left to right and from right to left.

Parameter	Setting	Range	Description
Dly(L)	200.0ms	Same as program 28	Same as program 28
FB.G(L)	+40%		
Dly(R)	350.0ms		
FB.G(R)	+40%		
Hi.Ratio	0.4		
LPF	THRU		
HPF	THRU		
Ini.Dly	0.1ms		
L->R Bal	34%		
R->L Bal	34%		

Program 30 — CROSS DELAY

The echo feedback signal crosses completely.

Parameter	Setting	Range	Description
Dly(L)	220.0ms	Same as program 28	Same as program 28
FB.G(L)	+44%		
Dly(R)	180.0ms		
FB.G(R)	-55%		
Hi.Ratio	0.2		
LPF	THRU		
HPF	THRU		
Ini.Dly	0.1ms		
L->R Bal	100%		
R->L Bal	100%		

Program 31 — CHORUS1

A stereo chorus. Creates a rich, thickening effect.

Parameter	Setting	Range	Description
Freq.	0.6Hz	0.1~40.0Hz	Modulation frequency.
AM Depth	49%	0~100%	Amplitude modulation depth.
PM Depth	35%	0~100%	Pitch modulation depth.
LSF F	220Hz	32Hz~1.0kHz	Low shelving filter frequency.
LSF G	+3dB	-12 ~ +12dB	Low shelving filter gain.
Mod.Dly	12.1ms	0.0~255.0ms	Chorus delay. The delay time before modulation starts.
EQ F	560Hz	160Hz~8.0kHz	Equalizer frequency.
EQ G	-1dB	-12 ~ +12dB	Equalizer signal gain.
HSF F	4.0kHz	1.0~10.0kHz	High shelving filter frequency.
HSF G	+1dB	-12 ~ +12dB	High shelving filter gain.

Program 32 — CHORUS2

This is a variation on program 31. The modulation is much thicker and shimmering.

Parameter	Setting	Range	Description
Freq.	0.6Hz	Same as program 31	Same as program 31
AM Depth	49%		
PM Depth	35%		
LSF F	220Hz		
LSF G	0dB		
Mod.Dly	12.1ms		
EQ F	560Hz		
EQ G	0dB		
HSF F	4.0kHz		
HSF G	0dB		

Program 33 — BROAD CHORUS

This is a variation on program 31, with more spread and spaciousness.

Parameter	Setting	Range	Description
Freq.	0.5Hz	Same as program 31	Same as program 31
AM Depth	64%		
PM Depth	90%		
LSF F	180Hz		
LSF G	+2dB		
Mod.Dly	38.0ms		
EQ F	560Hz		
EQ G	0dB		
HSF F	3.2kHz		
HSF G	+2dB		

Program 34 — FLANGE

Stereo flanger. Creates a rich, swirling effect, full of harmonics.

Parameter	Setting	Range	Description
Freq.	1.2Hz	0.1~40.0Hz	Modulation frequency.
Depth	25%	0~100%	Modulation depth.
FB.Gain	+45%	-99 ~ +99%	Feedback gain. The amount of signal returned to the effect.
LSF F	63Hz	32Hz~1.0kHz	Low shelving filter frequency.
LSF G	0dB	-12 ~ +12dB	Low shelving filter gain.
Mod.Dly	14.6ms	0.0~255.0ms	Flange delay. The delay time before modulation starts.
EQ F	630Hz	160Hz~8.0kHz	Equalizer frequency.
EQ G	+2dB	-12 ~ +12dB	Equalizer signal gain.
HSF F	3.2kHz	1.0~10.0kHz	High shelving filter frequency.
HSF G	0dB	-12 ~ +12dB	High shelving filter gain.

Program 35 — SYMPHONIC

This program creates a rich and grand chorus effect, bigger than chorus alone.

Parameter	Setting	Range	Description
Freq.	0.6Hz	0.1~40.0Hz	Modulation frequency.
Depth	8%	0~100%	Modulation depth.
Mod.Dly	2.4ms	0.0~255.0ms	Modulation delay. The delay time before modulation starts.
LSF F	63Hz	32Hz~1.0kHz	Low shelving filter frequency.
LSF G	0dB	-12 ~ +12dB	Low shelving filter gain.
EQ F	500Hz	160Hz~8.0kHz	Equalizer frequency.
EQ G	0dB	-12 ~ +12dB	Equalizer signal gain.
HSF F	6.3kHz	1.0~10.0kHz	High shelving filter frequency.
HSF G	-2dB	-12 ~ +12dB	High shelving filter gain.

Program 36 — TREMOLO

A stereo tremolo, just like on a classic guitar amplifier. It creates a fat sound that is great with guitars.

Parameter	Setting	Range	Description
Freq.	3.1Hz	0.1~40.0Hz	Modulation frequency.
AM Depth	84%	0~100%	Amplitude modulation depth.
PM Depth	6%	0~100%	Pitch modulation depth.
LSF F	250Hz	32Hz~1.0kHz	Low shelving filter frequency.
LSF G	+2dB	-12 ~ +12dB	Low shelving filter gain.
EQ F	630Hz	160Hz~8.0kHz	Equalizer frequency.
EQ G	+1dB	-12 ~ +12dB	Equalizer signal gain.
HSF F	2.8kHz	1.0~10.0kHz	High shelving filter frequency.
HSF G	+1dB	-12 ~ +12dB	High shelving filter gain.

Program 37 — AUTO PAN

This effect performs automatic panning across the stereo image.

Parameter	Setting	Range	Description
Freq.	0.5Hz	0.1~40.0Hz	Modulation frequency.
LR Depth	98%	0~100%	Left to right pan depth.
FR Depth	15%	0~100%	Front to rear pan depth.
LSF F	140Hz	32Hz~1.0kHz	Low shelving filter frequency.
LSF G	+4dB	-12 ~ +12dB	Low shelving filter gain.
Dir.	L<->R	Pan direction	Choose from L<->R, L->R, L<--R, Turn L, or Turn R.
EQ F	630Hz	160Hz~8.0kHz	Equalizer frequency.
EQ G	+3dB	-12 ~ +12dB	Equalizer signal gain.
HSF F	3.2kHz	1.0~10.0kHz	High shelving filter frequency.
HSF G	0dB	-12 ~ +12dB	High shelving filter gain.

Program 38 — PHASING

Stereo phaser. This effect simulates old phase shifter effects.

Parameter	Setting	Range	Description
Freq.	1.3Hz	0.1~40.0Hz	Modulation frequency.
Depth	52%	0~100%	Modulation depth.
FB.Gain	+68%	-99 ~ +99%	Feedback gain. The amount of signal returned to the effect.
Offset	32	0 ~ 100	Phase offset. The amount that the signal phase is offset.
Stage	4	4, 6, 8	Stage of phase.
LSF F	250Hz	32Hz~1.0kHz	Low shelving filter frequency.
LSF G	+2dB	-12 ~ +12dB	Low shelving filter gain.
HSF F	3.6KHz	1.0~10.0kHz	High shelving filter frequency.
HSF G	+1dB	-12 ~ +12dB	High shelving filter gain.

Program 39 — ST.PITCH CHANGE

Two-part stereo pitch shifter. This stereo effect changes the pitch of the left and right channels independently of each other.

Parameter	Setting	Range	Description
Pitch	0	-12 ~ +12	Coarse pitch change for pitch changers 1 and 2.
Fine(1)	+20	-50 ~ +50	Fine pitch for pitch changer 1.
Fine(2)	-20	-50 ~ +50	Fine pitch for pitch changer 2.
Out(1)	+100	-100 ~ +100	Output volume level for pitch changer 1.
Out(2)	+100	-100 ~ +100	Output volume level for pitch changer 2.
Pan(1)	L100	L100~R100	Pan control for pitch changer 1.
Pan(2)	R100	L100~R100	Pan control for pitch changer 2.
FB.G(1)	+28%	-99 ~ +99%	Feedback gain for pitch changer 1.
FB.G(2)	-28%	-99 ~ +99%	Feedback gain for pitch changer 2.
Delay	25.0ms	0.1~255.0ms	Delay time before the feedback starts.

Program 40 — VOCAL DOUBLER

This is a thin harmonizing effect obtained by setting a longer delay.

Parameter	Setting	Range	Description
Pitch	0	Same as program 39	Same as program 39
Fine(1)	+5		
Fine(2)	-10		
Out(1)	+100		
Out(2)	+100		
Pan(1)	L6		
Pan(2)	R6		
FB.G(1)	+10%		
FB.G(2)	-10%		
Delay	60.0ms		

8

Scene Memories

In this chapter...

What are Scene Memories?	114
What is Stored in a Scene Memory?	115
What is the Edit Buffer?	115
Initial Data and UNDO Memory	115
Storing Mix Scenes	116
Naming a Scene Memory	117
Recalling Scene Memories	119
Fader Recall Safe	120
Fade Time	121

What are Scene Memories?

Scene memories are a snapshot of all the Digital Recording Console 02R mixer setting. There are 64 mix scene memory locations. Each can be named for easy identification. They can be stored and recalled manually using the [STORE] and [RECALL] buttons. They can also be recalled by the automation (AUTOMIX) system or by using MIDI Program Changes from a computer, MIDI sequencer, or MIDI footswitch. You can also save scene memories to a MIDI data file.

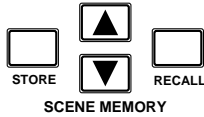

The title and number of the current scene memory are shown at the top left side of the display.

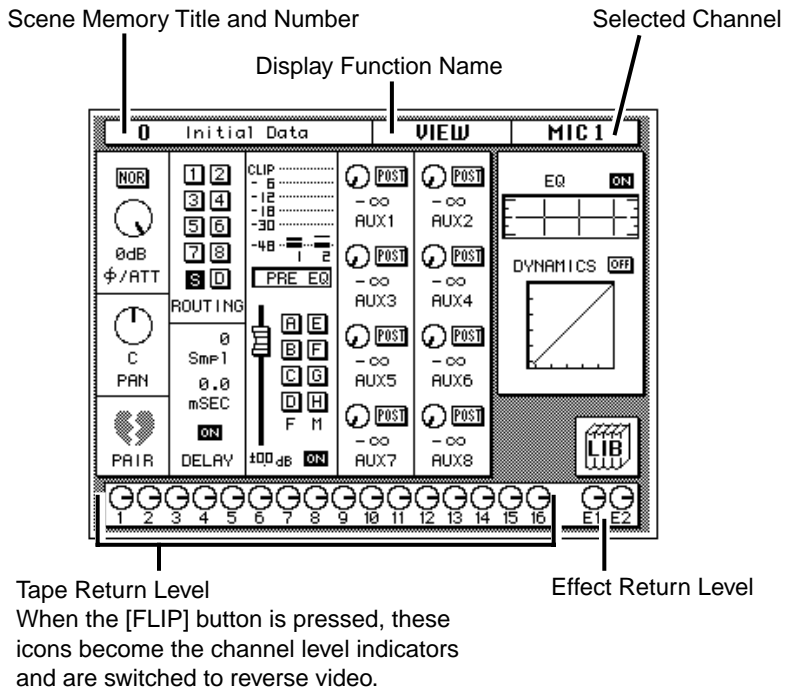

When the [FLIP] button is pressed, these icons become the channel level indicators and are switched to reverse video.



The number and status of the scene memory is also shown in the SCENE MEMORY LED beside the display screen. When you select a new scene memory with the SCENE MEMORY increment or decrement buttons, the number in the scene memory indicator flashes.

Use the [RECALL] button to load the selected scene memory into the current edit buffer. When you first change a parameter in the recalled memory, the Edit Indicator starts to flash. To save your changes, select a scene memory with the increment or decrement buttons and press the [STORE] button. The 02R will request you confirm the action.

What is Stored in a Scene Memory?

Virtually all Digital Recording Console 02R mix settings are stored in a scene memory. Settings that are not stored consist mainly of analog controls and switches. They are: +48V phantom switches, A/B input switches, 20dB (pad) switches, GAIN controls, T/B LEVEL control, STUDIO LEVEL control, PHONES LEVEL control, C-R LEVEL control, and the display CONTRAST control.

MIDI setup and assignment table data are also not stored in the scene memory.

What is the Edit Buffer?

The Edit Buffer is the current mix settings. When a scene memory is recalled, the mix settings of the selected scene memory are written to the Edit Buffer. When a scene memory is stored, the mix settings in the Edit Buffer are written to the selected scene memory.

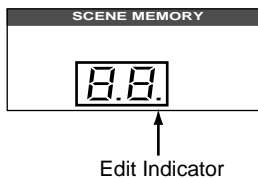

The first time you adjust a parameter in the current mix settings, the Edit Indicator of the SCENE MEMORY indicator on the display panel will start to flash. This indicates that the current mix settings – those in the Edit Buffer – do not match those of the scene memory previously recalled.

Initial Data and UNDO Memory

The Digital Recording Console 02R has two special scene memory locations. Scene number "0" (zero) and scene number "U" are read-only memory locations.

Scene number "0 – Initial Data" contains the initial mix settings for the 02R. When you want to reset all the mixer settings to their initial values, recall this scene memory.

Scene number "U" is the UNDO memory. It always contains a copy of the last scene memory. Even if you have pressed the [STORE] button and confirmed the operation, you can still recall the contents of the overwritten scene memory by recalling scene number "U".

Storing Mix Scenes

1. Use the increment or decrement buttons to select a scene memory.

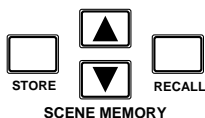

2. Press the (STORE) button.
3. The confirmation popup appears on the display. By default “CANCEL” is selected.
4. Use the CURSOR buttons to select “EXECUTE” and press the (ENTER) button.
5. The mix scene is stored.

The Digital Recording Console 02R has 64 scene memory locations. You can save additional scenes to a MIDI data filer. Scene memories can be named for easy identification.

When you are about to store a scene memory, make sure there are no settings in the Edit Buffer that you do not want to store. Maybe some settings have been adjusted accidentally, or by someone else. If you are not sure about the Edit Buffer’s exact contents, first recall the last scene memory, make the adjustments that you really want, and then store. You may want to store the current mix settings to an unused scene memory, just in case.

Storage Confirmation

When you save the mixer settings to a scene memory location, the 02R will display a popup confirmation request message. The popup has two control icons: “CANCEL” and “EXECUTE”, as shown below:



Note: You can customize your 02R to prevent the confirmation popup from appearing during the STORE operation. See “Preferences” on page 162 of the User’s Guide for more information.

CANCEL is the default. To cancel the STORE operation, either press the [ENTER] button or wait about 10 seconds – the STORE operation will be automatically cancelled. A prompt indicating the operation has been cancelled will flash momentarily on the display.

To store your settings, use the CURSOR buttons to select the “EXECUTE” control icon and press the [ENTER] button. The program is stored.

Note: When a scene memory is stored, all the previous data in the selected scene memory is overwritten. The 02R has an UNDO function, but you should still be careful not to overwrite an important scene memory.

YOU SHOULD ALWAYS BE CAREFUL WHEN THE 02R DISPLAYS ITS CONFIRMATION POPUP MESSAGE!

Reorganizing Scene Memories

By recalling a scene memory and then storing it to another location, you can copy and reorganize your scene memories.

Naming a Scene Memory

1. Press the (SCENE MEMORY) button.



A SCENE MEMORY display function appears. Press the (SCENE MEMORY) button again until the first display function is shown.

2. Use the CURSOR buttons to select the title edit box.
3. Select the individual character positions with the CURSOR buttons. Rotate the encoder wheel to select characters for your title.
4. Press the (STORE) button. Respond to the confirmation popup by selecting "EXECUTE" and pressing the (ENTER) button. The scene memory is stored.

To name a scene memory, you need to select the scene memory display functions.

Display Screen

Shown below is the first SCENE display function:

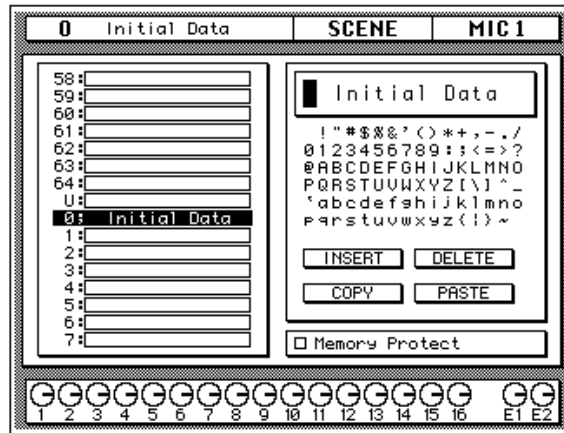

You may have to press the [SCENE MEMORY] button several times to get to this screen.

The left side of the display shows a list of the scene memories. The name of the scene memory under the cursor is highlighted. The SCENE MEMORY increment or decrement buttons are used to scroll through the list.

Beside the list of scene memories is the title edit field. The CURSOR buttons are used to select the character, and the encoder wheel is used to change its value. A table of the available characters is shown below the title edit field.

Below the character table are four control button icons. Use the CURSOR buttons to select from the INSERT, DELETE, COPY, or PASTE icons.

At the bottom of the right side of the display is the Memory Protect check box. When this box is checked, all scene memory is protected from the storage operations.

Character Set

A scene memory name can be up to 16 characters long and can contain any of the following characters:

	!	“	#	\$	%	&	'	()	*	+	,	-	.	/
0	1	2	3	4	5	6	7	8	9	:	;	<	=	>	?
@	A	B	C	D	E	F	G	H	I	J	K	L	M	N	O
P	Q	R	S	T	U	V	W	X	Y	Z	[\]	^	_
`	a	b	c	d	e	f	g	h	i	j	k	l	m	n	o
p	q	r	s	t	u	v	w	x	y	z	{		}	~	

Control Icons

- **INSERT** – This icon is used to insert blank characters into the title edit box at the current cursor location. Select the icon with the CURSOR buttons and press the [ENTER] button.
- **DELETE** – This icon is used to delete characters from the title edit box at the current cursor location. Select the icon with the CURSOR buttons and press the [ENTER] button.
- **COPY** – This icon is used to copy the name of another scene memory. Select the icon with the CURSOR buttons. Use the encoder wheel to select a scene memory and press the [ENTER] button. The scene memory name is copied into an edit buffer.
- **PASTE** – This icon is used to paste a scene memory name previously selected with the COPY operation into the title edit box. Select the icon with the CURSOR buttons and press the [ENTER] button. The scene memory name is pasted from the edit buffer into the title edit box, replacing any text that was there. You can then edit the text to create a unique scene memory name.

Protecting Scene Memories

You can protect stored mix scenes against accidental overwriting using this Memory Protect function. This is useful when you've set up many mix scenes for repeated use, or when inexperienced users operate Digital Recording Console 02R.

When the Memory Protect is checked, mix settings cannot be stored using the [STORE] button. Any scene memory data received as MIDI Bulk Dump is also ignored.

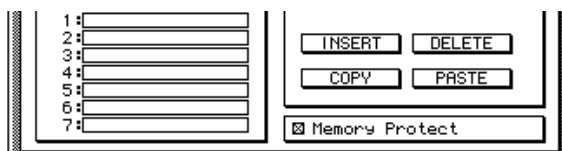

Recalling Scene Memories

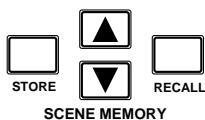

Scene memories are recalled using the [RECALL] button. They can also be recalled using MIDI Program Changes.

Note: *When you recall a scene memory, all mix settings in the Edit Buffer (current mix scene) are overwritten. You may want to store the Edit Buffer to an unused scene memory before recalling, just in case.*

Note: *When recalling mix scenes, be aware that volume levels may change suddenly as channels are switched ON and faders moved. The 02R has a feature that allows you to fade the levels as a scene memory is loaded, but it cannot compensate for the sudden burst of a channel suddenly being switched on. See "Fade Time" on page 121 of the User's Guide*

Fader Recall Safe

1. Press the (SCENE MEMORY) button repeatedly until the “Fader Recall Safe” screen appears.



2. Use the CURSOR buttons to select the “Enable/Disable” options and use the (ENTER) button to ENABLE the safe function.
3. Select the individual channels with the (SEL) buttons or the CURSOR buttons. Press the (ENTER) button to enable a channel. Its icon is highlighted in reverse video.
4. Press the (STORE) button. Respond to the confirmation popup by selecting “EXECUTE” and pressing the (ENTER) button. The scene memory is stored.

The Digital Recording Console 02R has two methods of protecting the system from sudden volume level changes when a scene memory is recalled. You can select individual channels to safety. When the scene memory is recalled, the fader level will not change from the level it was set to in the previous mix.

Shown below is the second SCENE display function, the “Fader Recall Safe” screen:

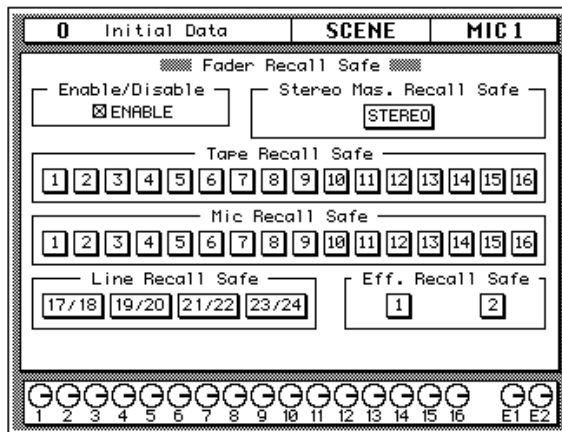

You may have to press the [SCENE MEMORY] button several times to get to this screen.

The “Enable/Disable” controls are in the top left corner of the display. Use the CURSOR buttons to select ENABLE check box and press the [ENTER] button.

The remainder of the screen contains control icons for each of the input and return channels plus the stereo master fader. Select an icon and press the [ENTER] button to safety a channel.

In order for the “Fader Recall Safe” function to have any effect, you must store the scene memory (see “Storing Mix Scenes” on page 116 of the *User’s Guide*).

Restoring the Faders

To restore the fader movements, select the “DISABLE” option and press the [ENTER] button. Reset the fader levels. Then store the scene memory again (see “Storing Mix Scenes” on page 116 of the *User’s Guide*).

Note: If you DISABLE the fader recall safe or switch off the individual channels and then store the scene memory, be aware that the current fader levels will be stored in the memory, not the levels that were previously stored there.

Fade Time

1. Press the (SCENE MEMORY) button repeatedly until the "Fade Time" screen appears.



2. Select the individual channels with the (SEL) buttons or the CURSOR buttons. Rotate the encoder wheel to set the fade time value.
3. Press the (STORE) button. Respond to the confirmation popup by selecting "EXECUTE" and pressing the (ENTER) button.

The scene memory is stored.

The second method of protecting the system from sudden volume level changes is to set the fade time for each channel. When the scene memory is recalled, the fader level will change from its previous level to the new level of the recalled memory. You can control the duration of the change.

Shown below is the third SCENE display function, the "Fade Time" screen:

0 Initial Data				SCENE				MIC 1			
Mic		Tape		Line/Rtn/ST		[SEC]					
1	0.0	9	0.0	1	0.0	9	0.0	17	0.0	E1	0.0
2	0.0	10	0.0	2	0.0	10	0.0	18			
3	0.0	11	0.0	3	0.0	11	0.0	19	0.0	E2	0.0
4	0.0	12	0.0	4	0.0	12	0.0	20			
5	0.0	13	0.0	5	0.0	13	0.0	21	0.0		
6	0.0	14	0.0	6	0.0	14	0.0	22			
7	0.0	15	0.0	7	0.0	15	0.0	23	0.0	ST	0.0
8	0.0	16	0.0	8	0.0	16	0.0	24			

You may have to press the [SCENE MEMORY] button several times to get to this screen.

The display consists of all the "Mic", "Tape" and "Line/Rtn/ST" channels with a fade time value beside each. You can set the fade time from 0.0sec to 10.0sec.

Note: If you double-click the [ENTER] button on a selected channel, all the channels will be set to the same fade time as that channel.

In order for the fade time you set to have any effect, you must store the scene memory (see "Storing Mix Scenes" on page 116 of the *User's Guide*).

9

Automation

In this chapter...

What is the Automation Function?	124
What is Timecode?	126
Automation Function	128
Main Screen	129
Memory Management	133
Fader Edit	136
Event Edit (MEMORY)	138
Event Edit (CH ON)	139
Event Extract	140

What is the Automation Function?

One of the most demanding jobs of the recording engineer is taking all the raw material produced during a multitrack recording session and mixing it all together into an artistically satisfying master recording. The ability to setup portions of the mix and then have them playback automatically as you work on other portions is probably the most important feature of any digital recording studio.

The Digital Recording Console 02R has an on-board automation system that memorizes fader positions, switches individual channels on or off, adjusts the equalization or pan positions, and changes the auxiliary sends – all based on timecode. It can record and execute scene memory changes, also determined by timecode. This allows you to perform an entire mixing session, and then edit individual channel settings until you have achieved a perfect mix.

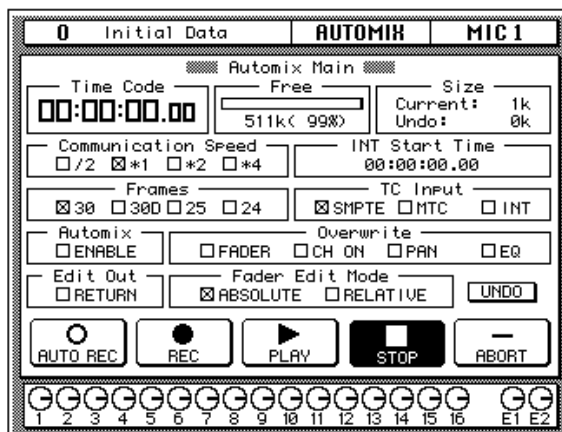

What is Stored in an AUTOMIX Memory?

An AUTOMIX memory starts with a scene memory and a time start. As each parameter is adjusted, the adjustment and the associated time is recorded in memory. The parameters that are recorded include fader positions, channel settings (on or off), changes to the equalization and the pan position, and level changes for the auxiliary sends. The more complicated the mix, the more memory it consumes.

What is the 02R Memory Capacity?

The 02R has a current AUTOMIX buffer and 16 AUTOMIX memories. There is also an undo buffer. Only the current mix can be played back and recorded. You can store the current mix in any of the 16 automix memories.

The default memory capacity of the 02R is 512kB. Total size of the current mix and the 16 AUTOMIX memories should be under 512kB. If you find

yourself running out of memory, you can download unused AUTOMIX memories to a storage device, such as a MIDI data filer, then clear the memories. You can also expand the available memory with 1Mbyte expansion kits (ME4M). You can install up to two of these kits in the 02R, resulting in a maximum memory size of 2.5Mbytes.

What is the Current Buffer?

The only automix program that can be recorded or played back is the current AUTOMIX buffer. When you perform edits to the current buffer, its previous state is saved in an undo buffer. You can always undo the last edit operation.

Note: *You cannot undo a STORE operation. Once you have confirmed the operation, the previous AUTOMIX memory contents have been overwritten.*

What is Timecode?

Timecode is a signal that contains a chronological record of the absolute time in a recording. It is used for synchronizing different recorders. It can be used for electronic editing. Timecode was initially invented for the motion picture business, as a method of synchronizing the pictures recorded in the frames of a camera to the sound recorded on tape recorder.

The 02R supports three types of timecode:

- SMPTE timecode
- MTC (MIDI timecode)
- Internal timecode

When you synchronize the 02R to an external device such as a multitrack recorder or MIDI sequencer, the external device will provide SMPTE or MTC timecode to allow the automix to synchronize with the data on the recorder or sequencer.

Using SMPTE Timecode

SMPTE timecode is a synchronization signal developed for the film and television industries (Society of Motion Picture and Television Engineers). It is normally implemented as timing pulses converted into an audio signal and recorded onto tape or film. Some devices are able to transmit SMPTE timecode directly.

SMPTE indicates an absolute time in hours:minutes:seconds:frames. There are four basic formats, depending on the number of frames that a second is divided into:

- 24 frames per second.
- 25 frames per second.
- 29.97 frames per second (30 drop frame).
- 30 frames per second.

Use SMPTE timecode when you want to synchronize the 02R automation system with video recorders, a multitrack recorder, or other film and video post-production recorders.

Connections

If the connected device can directly output SMPTE timecode, use an audio cable to connect the output to the TIME CODE INPUT – SMPTE connector on the back of the 02R.

If the connected device does not have a dedicated SMPTE output connector, record the timecode onto a spare track (in the case of a multitrack recorder) or a special track (in the case of a video recorder or film post-production recorder) and connect the output from that track to the timecode input connector on the 02R.

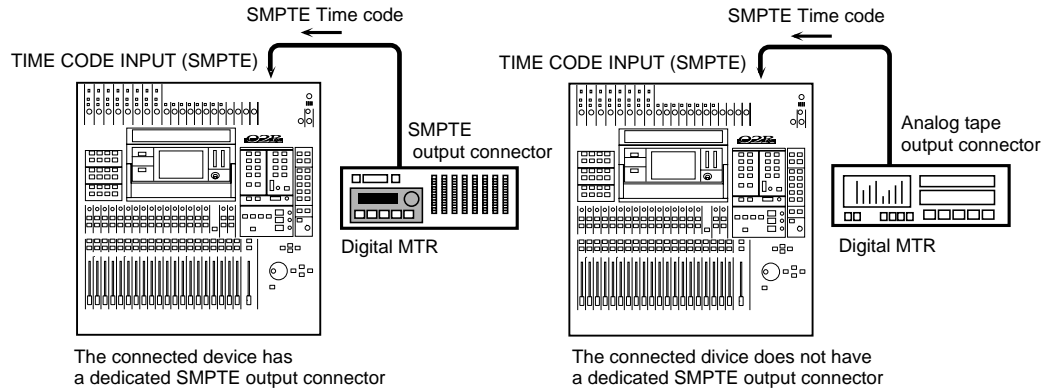

Using MIDI Timecode (MTC)

MTC is a MIDI System message that indicates absolute time in hours:minutes:seconds:frames, in the same fashion as SMPTE. MTC is an alternate method of transferring the timecode data from one device to another.

Use MTC when you want to synchronize the 02R automation system with MIDI sequencers or a multitrack recorder that has MTC output jacks. Use a MIDI cable to plug the MTC output connector of the controlling device into the TIME CODE INPUT – MTC connector on the back of the 02R.

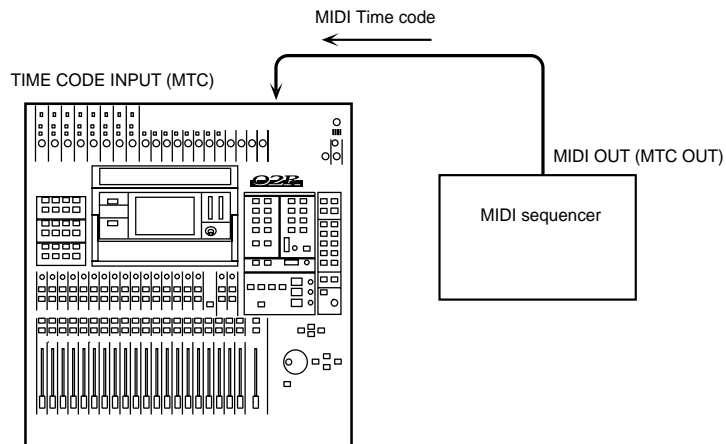

Note: When transmitting MTC to the 02R, you should use a dedicated output on the connected device. Otherwise the 02R has to discard MIDI playback data and other extraneous information, decreasing the accuracy of the timecode data.

Automation Function

1. Press the (AUTOMIX) button.



One of the AUTOMIX display function screens will appear.

Note: *The 02R always remembers the last function visited (and the last screen of that function) even after you turn the power off and back on again.*

2. Press the (AUTOMIX) button repeatedly to get to the desired screen.

The AUTOMIX display function is divided into six screens:

Main

The Main screen controls the record and playback operations. Select the frame-per-second rate, and the timecode input. Set the initial start time and enable the editing operations.

Memory Management

The Memory Management screen is used to name the AUTOMIX and perform store and recall operations. You can also control the record and playback operations from this screen.

Fader Edit

The Fader Edit screen is used to edit the fader positions and set motor parameters. You can also control the record and playback operations from this screen.

Event Edit (Memory)

The Event Edit (MEMORY) screen is used to edit memory events. Events can be inserted or deleted using the timecode as a reference point.

Event Edit (CH ON)

The Event Edit (CH ON) screen is used to edit channel on/off events. Events can be inserted or deleted using the timecode as a reference point.

Event Extract

The Event Extract screen allows you to select the channels and types of event parameters that you want to delete over a particular time duration.

Note: *You should also refer to the section "Mixing and Automation" on page 67 of the Getting Started Guide for additional tips on the operation of the 02R automation system.*

Main Screen

1. Press the (AUTOMIX) button repeatedly to get to the “Main” screen.



2. Use the CURSOR buttons to select a “Communication Speed” check box and press the (ENTER) button.

3. Select the “INT Start Time” with the CURSOR buttons and set the desired value by rotating the encoder wheel.

4. Use the CURSOR buttons to select the desired “Frame” rate check box and press the (ENTER) button.

5. Select a “TC Input” check box with the CURSOR buttons and press the (ENTER) button.

6. Use the CURSOR buttons to select the “Automix” ENABLE check box and press the (ENTER) button to change its value.

7. Select the “Overwrite” status check boxes with the CURSOR buttons and press the (ENTER) button.

continued...

The first AUTOMIX display function screen is shown below. This is the Main screen. From the first three screens – this screen, the Memory Management screen, or the Fader Edit screen – you can operate the automation transport controls:

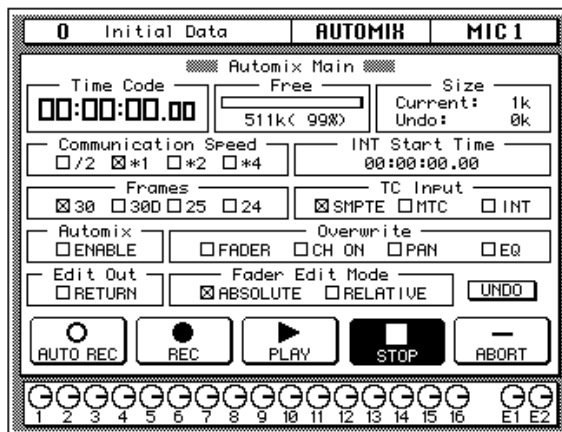

The top row of the display consists of the Time Code read-out, the current free memory size, shown in a bargraph, kilobytes, and percentage, and the size of the current memory buffer and the undo buffer.

The second row allows you to select the Communication Speed to a computer plugged into the TO HOST connector (clock÷2, clock×1, clock×2, or clock×4 – the default is 38.4kbps: clock×1) and set the INT (initial) Start Time.

In the third row, you set the number of Frames per second (30, 30drop, 25, or 24) and select the Time Code Input (SMPTE, MTC, or internal).

The fourth row allows you to set the Automix ENABLE and select the real-time edit Overwrite status (FADER, CH ON, PAN, or EQ).

In the fifth row, you set the Edit Out RETURN and select the Fader Edit Mode (ABSOLUTE or RELATIVE). At the end of the row is the UNDO icon, which allows you to undo the last edit operation.

The bottom row contains the automation transport control icons. Select from the following:

- **AUTOREC** – recording starts when the 02R receives timecode.
- **REC** – places the 02R in record ready mode.
- **PLAY** – starts playback of the automation program when timecode is received.
- **STOP** – stops recording or playback.
- **ABORT** – stops recording and discards any data recorded.

...continued

8. Use the **CURSOR** buttons to select the “Edit Out” **RETURN** check box and press the **(ENTER)** button to change its value.

9. Select a “Fader Edit Mode” check box with the **CURSOR** buttons and press the **(ENTER)** button.

Time Code Display

The 02R displays the received timecode in this large area on the screen. If you select INT (internal) timecode, the timecode display immediately starts to count the time. You can reset this value with the “INT Start Time” field.

Communication Speed

You can set the communication speed to a computer plugged into the TO HOST connector on the back of the 02R. The default speed is 38.4 kbps (kbaud), indicated by clock×1. This connector is used by a computer running the Project Manager software.

Timecode Type and Frame Rate

Select the timecode type from the following list:

- SMPTE timecode
- MTC (MIDI timecode)
- Internal (INT) timecode

Select the timecode frame rate from the following list:

- 24 frames per second.
- 25 frames per second.
- 29.97 frames per second (30 drop frame).
- 30 frames per second.

Automix ENABLE

When the 02R receives timecode during enable status (box checked), it will start playback of the AUTOMIX (or recording if it is in REC ready mode). If the 02R is in disable status, the AUTOMIX will not function.

Overwrite Mode

The automation system can record the following parameters: FADER, CH ON, PAN, or EQ. The FADER parameter includes the AUX send level. You can select whether or not to overwrite one of these four parameters.

Use the [SEL] button to select which channel the parameter is to be recorded from. The parameter will be overwritten during the record operation. During the overwrite operation, the [SEL] button will flash.

During automation recording, you cannot change a parameter settings unless the corresponding parameter has been selected and the channel

[SEL] button (edit key) has been pressed. If the parameter has been selected and the channel [SEL] button has been pressed, automation playback for that parameter will be stopped, and you can record new data.

Note: *It is possible to change a parameter during automation playback, but automation playback has priority.*

Edit Out Mode

This mode is effective only for the faders. It controls how to connect the current fader AUTOMIX with the previous fader data after editing the faders, disabling the parameter, or stopping the recording.

If RETURN is off (default setting – the box has not been checked), the fader will stay at the position it reached at the Edit Out time. When the first fader AUTOMIX event is found, the fader will follow the event.

If RETURN is on (box has been checked). the fader will return to the previous AUTOMIX position at the Edit Out time.

Fader Edit Mode

This mode is effective only for the faders. When it is set to ABSOLUTE, recording fader movement data overwrites the previously recorded data. When it is set to RELATIVE, the previous fader movement data is added to the fader movements during recording.

UNDO

This operation allows you to undo the following conditions: updating the automix (after recording has been stopped via the stop key or due to the interrupted timecode), recalling the data from the automix memory into the current mix, creating a new mix, or aborting the automix. It returns the current automix to its previous state.

Using the Transport Controls

1. Use the **CURSOR** buttons to select a transport control icon.
2. Press the **(ENTER)** button to operate the selected automation control.

Transport Controls

The following five operations have been made as control icons: AUTOREC, REC, PLAY, STOP, ABORT. Use the CURSOR buttons to select the desired operation and press the [ENTER] button.

AUTOREC – Selecting this icon will start AUTOMIX recording when the 02R receives timecode, even if it is not in REC ready mode. You can use this key when you do not want to press the REC ready key many times.

Note: *A channel must be selected with its [SEL] button in order for any automation events to be recorded.*

REC – Selecting this icon will cause the unit to enter REC ready mode. The icon will flash. The 02R starts recording when it receives timecode during REC ready mode. The icon will be highlighted in reverse video. Selecting this icon during AUTOMIX playback will cause the 02R to enter REC ready mode. Selecting the PLAY icon will start a punch-in recording.

Note: *A channel must be selected with its [SEL] button in order for any automation events to be recorded.*

PLAY – Selecting this icon when timecode is being received and the AUTOMIX is stopped will play back the automix. Selecting this icon while the 02R is in record ready mode will start a punch-in recording.

Note: *A channel must be selected with its [SEL] button in order for any automation events to be recorded.*

STOP – Selecting this icon will stop the playback and/or recording of the AUTOMIX. When recording is stopped, the data will be stored as the new current mix.

ABORT – Selecting this icon will stop the playback or recording of the AUTOMIX. When the recording is stopped, the data will be discarded. (Internally, the data is stored in memory for the undo operation.)

Memory Management

1. Press the (AUTOMIX) button.



An AUTOMIX display function appears.

Press the (AUTOMIX) button repeatedly to get to the “Memory Management” screen.

2. Use the encoder wheel to select an AUTOMIX memory from the scrolling list.
3. Select the RECALL icon with the CURSOR buttons and press the (ENTER) button.
4. Edit the title with the CURSOR buttons, encoder wheel, and (ENTER) button.
5. Use the CURSOR buttons to select the “Automix” ENABLE check box and press the (ENTER) button.
6. Select the “Overwrite” check boxes with the CURSOR buttons and press the (ENTER) button.
7. Use the CURSOR buttons to select “Edit Out” RETURN check box and press the (ENTER) button.
8. Use the CURSOR buttons and the (ENTER) button to operate the automation transport.

The second AUTOMIX display function is the Memory Management screen shown below:

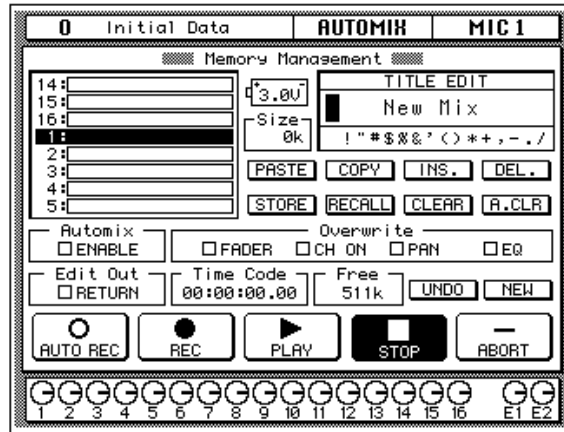

The top left of the display shows a scrolling list of the 16 AUTOMIX memories.

The top right of the display is the Title Edit field. The CURSOR buttons are used to select the character, and the encoder wheel is used to change its value. AUTOMIX memory names can be up to 16 characters long.

Below the Title Edit field are the edit control button icons. Use the CURSOR buttons to select from the PASTE, COPY, INS., DEL., STORE, RECALL, CLEAR, and A.CLR icons.

Between the list of AUTOMIX memories and the Title Edit field is the memory Size indicator.

The bottom of the display consists of three rows. The first row allows you to set the Automix ENABLE and select the real-time edit Overwrite status (FADER, CH ON, PAN, or EQ).

The second row allows you set the Edit Out RETURN. Beside that is the current Time Code read-out and the Free memory indicator. At the end of the row are the UNDO (which allows you to undo the last edit operation) and NEW (which creates a new automix in the current buffer) icons.

The last row on the bottom contains the automation transport control icons (AUTOREC, REC, PLAY, STOP, or ABORT).

AUTOMIX Name Edit Functions

AUTOMIX memory names can be up to 16 characters long and can contain any of the following characters:

	!	“	#	\$	%	&	'	()	*	+	,	-	.	/
0	1	2	3	4	5	6	7	8	9	:	;	<	=	>	?
@	A	B	C	D	E	F	G	H	I	J	K	L	M	N	O
P	Q	R	S	T	U	V	W	X	Y	Z	[\]	^	_
`	a	b	c	d	e	f	g	h	i	j	k	l	m	n	o
p	q	r	s	t	u	v	w	x	y	z	{		}	~	

- **COPY** – This icon is used to copy the name of an AUTOMIX program. Select the icon with the CURSOR buttons. Use the encoder wheel to select a program and press the [ENTER] button. The program name is copied into an edit buffer.
- **PASTE** – This icon is used to paste the AUTOMIX program name previously selected with the COPY operation into the TITLE EDIT box. Select the icon with the CURSOR buttons and press the [ENTER] button. The program name is pasted from the edit buffer into the TITLE EDIT box for subsequent editing.
- **INS.** – This icon is used to insert blank characters into the TITLE EDIT box at the current cursor location. Select the icon with the CURSOR buttons and press the [ENTER] button.
- **DEL.** – This icon is used to delete characters from the TITLE EDIT box at the current cursor location. Select the icon with the CURSOR buttons and press the [ENTER] button.

AUTOMIX Memory Edit Functions

- **STORE** – This icon is used to store the current AUTOMIX program to the library. Select the icon with the CURSOR buttons. Use the encoder wheel to select an AUTOMIX program and press the [ENTER] button. The 02R will display a popup confirmation request message asking if you want to store your settings in the selected program. The popup has two control icons: “CANCEL” and “EXECUTE”.

CANCEL is the default. To cancel the STORE operation, either press the [ENTER] button or wait about 10 seconds – the STORE operation will be automatically cancelled.

To store your settings, use the CURSOR buttons to select the “EXECUTE” control icon and press the [ENTER] button. The program is stored.

When you confirm a STORE operation, any existing data in the selected automix memory location will be overwritten. You cannot undo the STORE operation.

YOU SHOULD ALWAYS BE CAREFUL WHEN THE 02R DISPLAYS ITS CONFIRMATION POPUP MESSAGE!

-
- **RECALL** – This icon is used to recall an AUTOMIX program from the library. Select the icon with the CURSOR buttons. Use the encoder wheel to select an AUTOMIX program and press the [ENTER] button. The 02R will display a popup confirmation request message asking if you want to recall the selected program. The popup has two control icons: “CANCEL” and “EXECUTE”.

CANCEL is the default. To cancel the RECALL operation, either press the [ENTER] button or wait about 10 seconds – the RECALL operation will be automatically cancelled.

To store your settings, use the CURSOR buttons to select the “EXECUTE” control icon and press the [ENTER] button. The recalled program is now the current program. You can undo or redo the recall operation.

- **CLEAR** – delete the data located in the currently selected AUTOMIX memory location. You cannot undo the CLEAR function.
- **A.CLR** – delete all the data from all AUTOMIX memory locations. You cannot undo the ALL CLEAR function.

UNDO

This operation allows you to undo the following conditions: updating the automix (after recording has been stopped via the STOP transport function or due to the interrupted timecode), recalling the data from the automix memory into the current mix, creating a new mix, or aborting the automix. It returns the current automix to its previous state.

NEW

Before you can record an automix session, you must create a new automix. This operation allows you to create a new mix. As a default new mix, the current scene memory (the last scene memory to be stored or recalled) will be inserted at timecode location 00:00:00.00. Later, you can edit the timecode location using the AUTOMIX event edit operations.

Fader Edit

1. Press the (AUTOMIX) button.



An AUTOMIX display function appears.

Press the (AUTOMIX) button repeatedly to get to the “Fader Edit” screen.

2. Use the CURSOR buttons to select the MOTOR ON icon and press (ENTER) to change its value.
3. Select the “Fader Edit Out” RETURN check box with the CURSOR buttons and press the (ENTER) button. Rotate the encoder wheel to set a “Time” value.
4. Select the desired “Fader Edit Mode” check box with the CURSOR buttons and press the (ENTER) button.
5. Use the CURSOR buttons and the (ENTER) button to operate the automation transport.

The third AUTOMIX display function is the Fader Edit screen shown below:

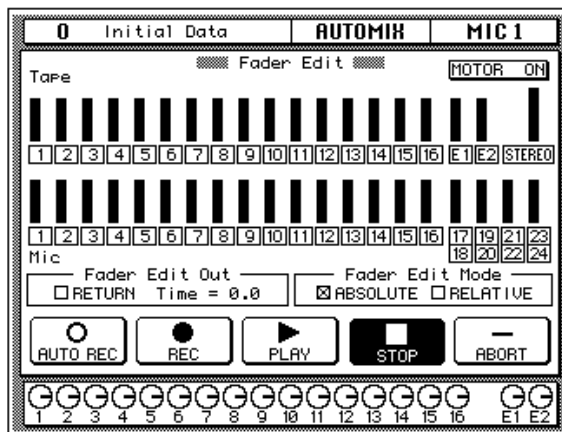

The top half of the display shows the current fader positions graphically for the input channels (MIC/LINE 1 through 16, LINE 17/18 through 23/24), the tape and effect return channels (TAPE 1 through 16, EFF1 and EFF2), and the stereo output. There is also the “MOTOR ON” icon.

The bottom of the display consists of two rows. The first row allows you set the Fader Edit Out RETURN and time, and select the Fader Edit Mode (ABSOLUTE or RELATIVE).

The last row contains the automation transport control icons (AUTOREC, REC, PLAY, STOP, or ABORT).

MOTOR ON

When you select this icon (the icon is in reverse video and the text reads MOTOR OFF), the fader motors are switched off during playback of an automix. The fader levels will still change according to the recording, but the faders will not move.

Fader Edit Out

You can control how the faders will return to the previously recorded values when you perform an overdub. If you select RETURN, when the 02R plays back the overdub, it will return the fader to the location previously recorded in the data. You can set a value between 0.0 and 3.0 seconds over which the fader will change levels.

If you do not select RETURN, the fader will remain in the last position until the next recorded movement.

Fader Edit

When you record a fader overdub, this display shows the previously recorded level and the new fader setting, plus an arrow indicating which direction the fader will have to be moved to return to the previous level.

Refer to the following diagram:

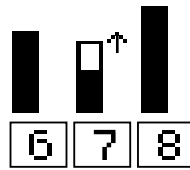

If the fader is moved to a position lower than the previously recorded position

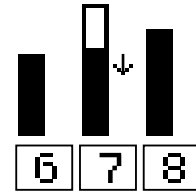

If the fader is moved to a position higher than the previously recorded position

Event Edit (MEMORY)

1. Press the (AUTOMIX) button.



An AUTOMIX display function appears.

Press the (AUTOMIX) button repeatedly to get to the the “Event Edit (MEMORY)” screen.

2. Use the CURSOR buttons to select an event to edit.
3. Use the CURSOR buttons to select the INSERT icon and press (ENTER) to insert an event.
4. Use the CURSOR buttons to select the DELETE icon and press (ENTER) to delete the current event.

The fourth AUTOMIX display function is the Event Edit (MEMORY) screen shown below:

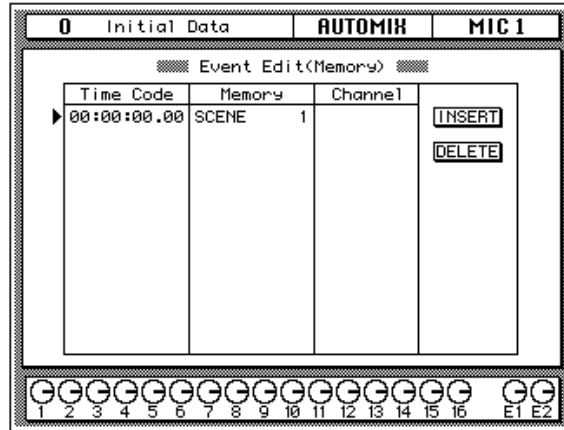

The display consists of a table listing Time Code, Memory (event), and Channel.

To the right of the table are two control icons; INSERT and DELETE. You can insert scene memory changes (no corresponding channel) and recall libraries (channel library, dynamics library, effect library, and equalizer library each with a corresponding channel).

When you insert an event, it is always given the same timecode value as the previous event. Use the CURSOR buttons to select the timecode field and adjust the timecode value to suit. Use the CURSOR buttons to select the event field and use the encoder wheel to select the desired event. Use the CURSOR buttons to select the channel field (not applicable if the event is a scene memory recall) and use the encoder wheel to select the desired channel.

When you change the timecode value for an event, the events are automatically sorted in timecode location.

Event Edit (CH ON)

1. Press the (AUTOMIX) button.



An AUTOMIX display function appears.

Press the (AUTOMIX) button repeatedly to get to the "Event Edit (CH ON)" screen.

2. Use the CURSOR buttons to select an event to edit.
3. Use the CURSOR buttons to select the INSERT icon and press (ENTER) to insert an event.
4. Use the CURSOR buttons to select the DELETE icon and press (ENTER) to delete the current event.

The fifth AUTOMIX display function is the Event Edit (CH ON) screen shown below:

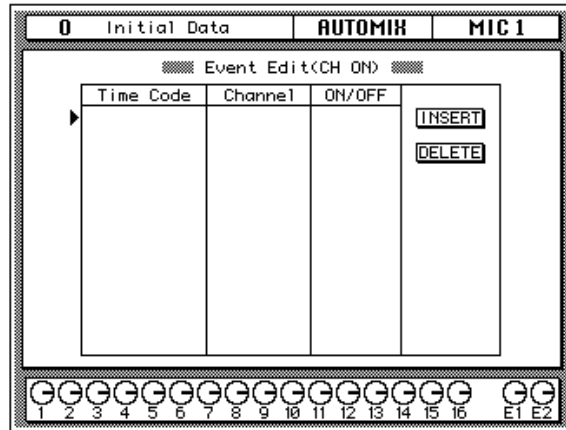

The display consists of a table listing Time Code, Channel, and ON/OFF (event).

There are two control icons to the right of the table; INSERT and DELETE. When you insert an event, it is always given the same timecode value as the previous event. Use the CURSOR buttons to select the timecode field and adjust the timecode value to suit. Change the channel or the ON/OFF values if required.

When you change the timecode value for an event, the events are automatically sorted in timecode location.

Event Extract

1. Press the (AUTOMIX) button.



An AUTOMIX display function appears.

Press the (AUTOMIX) button repeatedly to get to the “Event Extract” screen.

2. Select the desired “Tape” and/or “MIC” channel icons and the “Parameters” check boxes with the CURSOR buttons and press the (ENTER) button.
3. Use the CURSOR buttons to select “IN Time” and change the value with the encoder wheel.
4. Use the CURSOR buttons to select “Out Time” and change the value with the encoder wheel.
5. Select the EXTRACT control icon with the CURSOR buttons and press the (ENTER) button to execute the command.
6. Use the CURSOR buttons to select the UNDO control icon and press (ENTER) to undo the last command.

The last AUTOMIX display function is the Event Extract screen shown below:

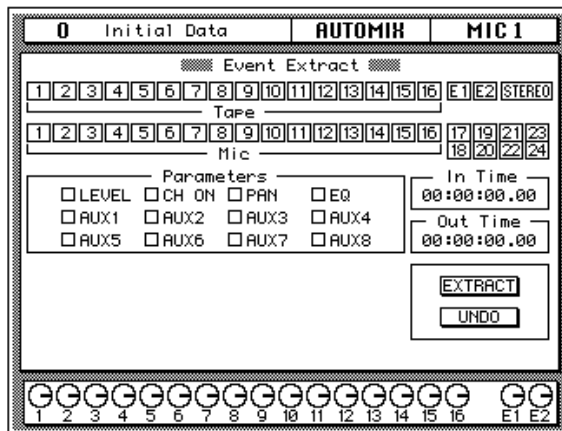

The top half of the display shows the channel status graphically for the input channels (MIC/LINE 1 through 16, LINE 17/18 through 23/24), the tape and effect return channels (TAPE 1 through 16, EFF1 and EFF2), and the stereo output. The channels you want to extract are highlighted in reverse video.

The bottom of the display consists of the “Parameter” block (LEVEL, CH ON, PAN, EQ, AUX1, AUX2, AUX3, AUX4, AUX5, AUX6, AUX7, and AUX8), the “In Time” timecode indicator, and the “Out Time” timecode indicator. Below are the EXTRACT and UNDO control icons.

EXTRACT

Selecting this icon causes the 02R to delete all the applicable events starting from the “In Time” timecode location up to, but not including, the “Out Time” timecode location.

ONE/ALL

If you double-click the [ENTER] button when the cursor is on a channel or an event type, that channel/event type will be turned on and all the other channels/event types turned off, or all channels/event types will be turned on. The 02R displays a confirmation popup which allows you to choose one channel/event type or all channels/event types:



Use the CURSOR buttons to select “ONE” to turn one channel/event type on and all the other channels/event types off, or select “ALL” to turn all the channels/event types on. Press the [ENTER] button to execute your choice.

10

MIDI

In this chapter...

MIDI and the 02R.	142
Setup	143
Program Change Assign.	144
Bulk Dump/Request.	145

MIDI and the 02R



The Digital Recording Console 02R is equipped with SMPTE and MTC synchronization plus a MIDI implementation. You will find that for most operations, MIDI is not required – indeed, because of the complexity of the 02R and the number of parameters available for adjustment, it is not possible to operate the unit by sending MIDI control change messages. Instead, parameter changes are implemented using MIDI system exclusive messages.

MIDI can be used to request or send bulk data, system exclusive parameter changes, and program change messages. The 02R uses the following MIDI messages:

- Program Change – to send or receive scene memory changes.
- System Exclusive – to send or receive parameter changes or bulk data transfers.

The 02R ignores any control change messages it receives.

Bulk Data Transfers

The 02R can send or receive the following types of bulk data:

- Scene Memories.
- Automix Memories.
- Effect Library Programs.
- Dynamics Library Programs.
- EQ Library Programs.
- Channel Library Programs.
- System Setup.
- Program Change Assign Table.

MIDI Display Function

The 02R MIDI display function consists of three screens:

- MIDI Setup
- MIDI Program Change Assign
- MIDI Bulk Dump & Request

See “MIDI Data Format” on page 206 of the *User’s Guide* for details of the 02R MIDI specifications.

Setup

1. Press the (MIDI) button.



A MIDI display function appears.

Press the (MIDI) button repeatedly until the "MIDI Setup" screen appears.

2. Use the CURSOR buttons to select the item you want to change and press the (ENTER) button.

Set the basic MIDI Receive and Transmit functions and select the MIDI channels you want the 02R to transmit and receive on.

Display Screen

Shown below is the first MIDI display function – the MIDI Setup screen:

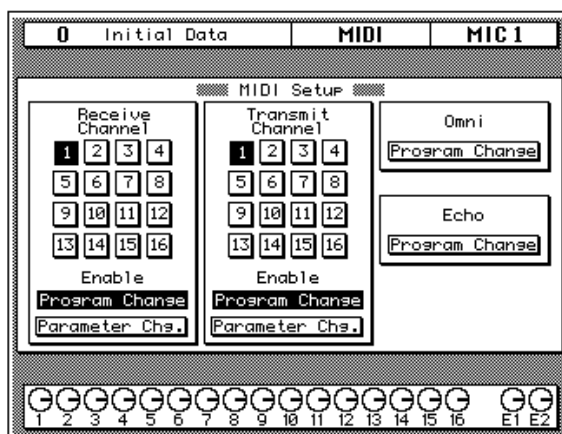

Receive Channel

Use these functions to set the Receive Channel, and select whether the 02R will receive Program Change and Parameter Change messages. When you change a Receive Channel item, it also changes the corresponding Transmit Channel item.

A Receive Channel item is selected/enabled when it is highlighted in reverse video.

Transmit Channel

Use these functions to set the Transmit Channel, and select whether the 02R will transmit Program Change and Parameter Change messages. Use these functions when you only want to change a Transmit Channel item

A Transmit Channel item is selected/enabled when it is highlighted in reverse video.

OMNI

Use this function to select whether the 02R will receive Program Change messages regardless of the Receive Channel setting. The function is enabled when it is highlighted in reverse video.

Echo

Use this function to select whether the received Program Change messages will be output. The 02R will retransmit the Program Change messages even if it is set to ignore them. The function is enabled when it is highlighted in reverse video.

Program Change Assign

1. Press the (MIDI) button.



MIDI

A MIDI display function appears.

Press the (MIDI) button repeatedly until the “MIDI Program Change Assign” screen appears.

2. Select a Program Change number with the CURSOR buttons. Use the encoder wheel to change the value of the corresponding Scene Memory number.

Press the (ENTER) button to enable or disable the current Scene Memory number. When a memory is disabled, “---” appears beside the Program Change number.

3. Use the CURSOR buttons to select the “TABLE RESET” control icon and press the (ENTER) button.
4. Select the “UNDO” control icon using the CURSOR buttons and press the (ENTER) button.

The 02R uses MIDI Program Change messages to recall scene memories.

Display Screen

Shown below is the second MIDI display function – the MIDI Program Change Assign screen:

0		Initial Data				MIDI				MIC 1					
MIDI Program Change Assign															
PGM=MEM		TABLE RESET				UNDO									
1= 1	2= 2	3= 3	4= 4	5= 5	6= 6	7= 7	8= 8	9= 9	10=10	11=11	12=12	13=13	14=14	15=15	16=16
17=17	18=18	19=19	20=20	21=21	22=22	23=23	24=24	25=25	26=26	27=27	28=28	29=29	30=30	31=31	32=32
33=33	34=34	35=35	36=36	37=37	38=38	39=39	40=40	41=41	42=42	43=43	44=44	45=45	46=46	47=47	48=48
49=49	50=50	51=51	52=52	53=53	54=54	55=55	56=56	57=57	58=58	59=59	60=60	61=61	62=62	63=63	64=64
65---	66---	67---	68---	69---	70---	71---	72---	73---	74---	75---	76---	77---	78---	79---	80---
81---	82---	83---	84---	85---	86---	87---	88---	89---	90---	91---	92---	93---	94---	95---	96---
97---	98---	99---	100---	101---	102---	103---	104---	105---	106---	107---	108---	109---	110---	111---	112---
113---	114---	115---	116---	117---	118---	119---	120---	121---	122---	123---	124---	125---	126---	127---	128= 0
GGGGGGGGGGGGGGGGGG GG															
1 2 3 4 5 6 7 8 9 10 11 12 13 14 15 16 E1 E2															

The default Program Change Assign table consists of a mapping of Program Change numbers 1 through 64 to Scene Memories 1 through 64. Program Change numbers 65 through 127 are mapped to nothing. Messages containing those Program Change numbers are ignored. Program Change number 128 is mapped to Scene Memory 0 (initial data).

TABLE RESET

The TABLE RESET command sets the Program Change Assign table back to its default mapping.

UNDO

The UNDO command restores the Program Change Assign table to its previous state.

Backup

You can create a Program Change Assign table and save it to a data storage device such as a MIDI data filer by executing the Program Change Assign table Bulk Dump command.

Bulk Dump/Request

1. Press the (MIDI) button.



A MIDI display function appears.

Press the (MIDI) button repeatedly until the “MIDI Bulk Dump & Request” screen appears.

2. Select the “TYPE” of data you want to dump or request with the CURSOR buttons and press the (ENTER) button.
3. Use the CURSOR buttons to select the “NUMBER” field and use the encoder wheel to select the desired program or memory.
4. Select the “EXECUTE” command with the CURSOR buttons and press the (ENTER) button to execute the MIDI bulk dump or request.

The 02R uses MIDI Bulk Dump and Request messages to store or recall scene memories, automix memories, system setup and program change tables, and effect, dynamics, equalizer, and channel library programs.

Display Screen

Shown below is the third MIDI display function – the MIDI Bulk Dump & Request screen:

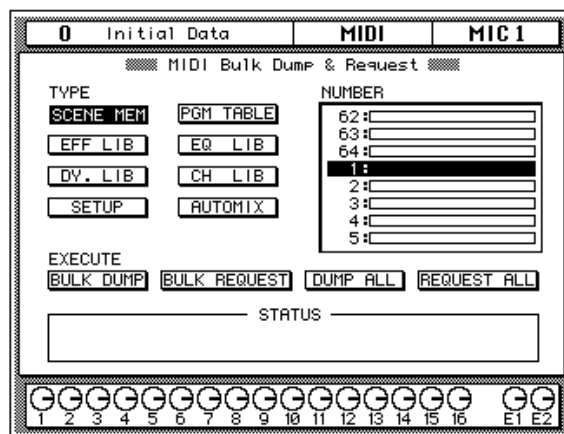

Type

This function allows you to select eight types of 02R data to Bulk Dump or Bulk Request:

- Scene Memories
- Automix Memories
- Channel Library Programs
- Dynamics Library Programs
- Effect Library Programs
- EQ Library Programs
- System Setup
- Program Change Assign Table

Number

For all of the data types except the System Setup and Program Change Assign Table data, you can select the number of the program or memory you want to dump or request. The list shows the program number and its corresponding name.

Execute

There are four commands you can execute:

- **BULK DUMP** – the data of the selected type and number will be output to the connected MIDI device.
- **BULK REQUEST** – the 02R will request the selected type and number from the connected MIDI device.
- **DUMP ALL** – all the programs or memories of the selected data type will be transmitted to the connected MIDI device.
- **REQUEST ALL** – the 02R will request all the programs or memories of the selected data type from the connected MIDI device.

When you execute one of the above commands, the 02R displays its current status in the STATUS field at the bottom of the display.

You can abort a bulk data transmission by moving the cursor with the CURSOR buttons.

11

Groups and Pairs

In this chapter...

Grouping Faders	148
Grouping Mutes.....	149
Pairing Channels	150

Grouping Faders

1. Press the (GROUP) button.



A GROUP display function appears. Press the (GROUP) button again if the “Fader Group” screen is not shown.

2. Use the CURSOR buttons to select from group A through D.
3. Use the (SEL) buttons to add or remove faders to and from the selected group.

Another method is to use the CURSOR buttons to select the faders and press the (ENTER) button.

Note: Stereo-pair channels are added or removed together.

4. Select a “Enable” group icon and turn it on or off by pressing the (ENTER) button.

When a group is off, the LEDs of the faders flash. The individual levels can be adjusted.

The Digital Recording Console 02R allows you to group the faders for multiple fader control using only one fader. This makes it easy to control several faders simultaneously. The input channel and the tape and effect returns can be grouped. There are four groups available: A, B, C, and D.

Display screen

Shown below is the first GROUP display function - the Fader Group screen. You can group the input channels – MIC/LINE 1 through 16 and LINE 17/18 through 23/24 – and the tape and effect returns – TAPE 1 through 16, EFF1 and EFF2:

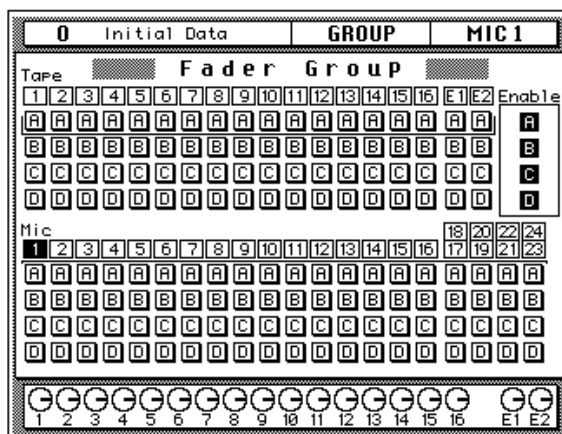

Select this screen by pressing the [GROUP] button. You may have to press more than once to get this screen - there are two screens in the GROUP display function.

The faders are listed in two main rows with the four group icons below each channel number.

On the right side of the display are the “Enable” group select icons. You can adjust the level balance within a group by turning the group on or off by selecting the corresponding icon (a group is ON when its icon is highlighted in reverse video) and pressing the [ENTER] button. The LEDs inset in the [SEL] buttons of the faders in the group will flash and they will be ungrouped temporarily, allowing you to adjust the individual fader levels.

If you try to operate multiple faders, the first fader you select will have priority. It is possible to upset the relative positions of the faders if you attempt to operate more than one at a time.

Note: A fader can only be assigned to one group. If you attempt to assign a fader to more than one group, the error message “Duplicate Grouping!” will flash on the display.

Grouping Mutes

1. Press the (GROUP) button.



A GROUP display function appears. Press the (GROUP) button until the "Mute Group" screen.

2. Use the CURSOR buttons to select from group E through H.
3. Use the (SEL) buttons to add or remove channels to and from the selected group.

Another method is to use the CURSOR buttons to select the channels and press the (ENTER) button.

Note: Stereo-pair channels are added or removed together.

4. Select a "Enable" group icon and turn it on or off by pressing the (ENTER) button.

When a group is off, the LEDs of the channels flash. You can change the channel status of any channel in the group.

The 02R also allows you to group channel status controls for multiple channel control using only one channel ON button. The channels in a group can be on or off depending on their status when they were grouped. Pressing a channel ON button toggles the status of all the channels in the group. There are four groups available: E, F, G, and H.

Display Screen

Shown below is the second GROUP display function - the Mute Group screen. You can group the input channels – MIC/LINE 1 through 16 and LINE 17/18 through 23/24 – and the tape and effect returns – TAPE 1 through 16, EFF1 and EFF2:

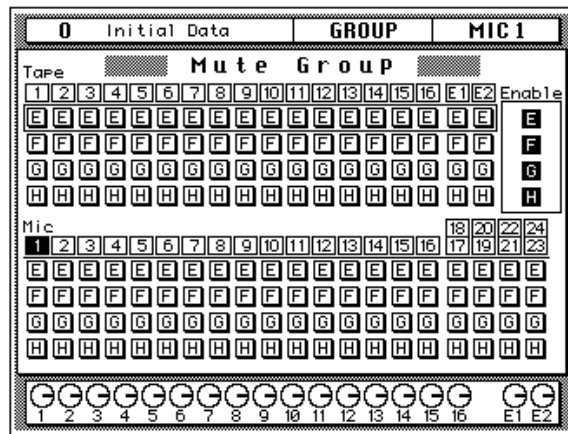

Select this screen by pressing the [GROUP] button. You may have to press more than once to get this screen.

The channels are listed in two main rows with the four group icons below each channel number.

On the right side of the display are the "Enable" group select icons. You can change the status of the channels within a group by disabling the group by selecting the corresponding icon (a group is enabled when its icon is highlighted in reverse video) and pressing the [ENTER] button. The LEDs inset in the [SEL] buttons of the channels in the group will flash and they will be ungrouped temporarily, allowing you to adjust the individual channel status of the group members.

Note: A channel can only be assigned to one group. If you attempt to assign a channel to more than one group, the error message "Duplicate Grouping!" will flash on the display.

Pairing Channels

1. Press the (PAIR) button.



The PAIR display function appears.

There are two screens in this function. You may have to press the (PAIR) button again to get to the "Pair" screen.

2. Use the CURSOR buttons to select a pair of adjacent channels and press the (ENTER) button to pair them.

1. Press the (PAIR) button again to select the "Aux Pair" screen.
2. Select a pair of adjacent auxiliary channels and press the (ENTER) button to pair them.

Adjacent channels can be paired for stereo operation. This makes it easy to work with stereo signals, because you only have to adjust one channel to control both left and right signals. The 02R allows you to link the input channels – MIC/LINE 1 through 16 – the tape return channels – TAPE 1 through 16 – and the auxiliary send channels AUX 1 through AUX 6.

Channel Pair Display Screen

Shown below is the first PAIR display function - the channel Pair screen. You can pair the input channels – MIC/LINE 1 through 16 – and the tape returns – TAPE 1 through 16:

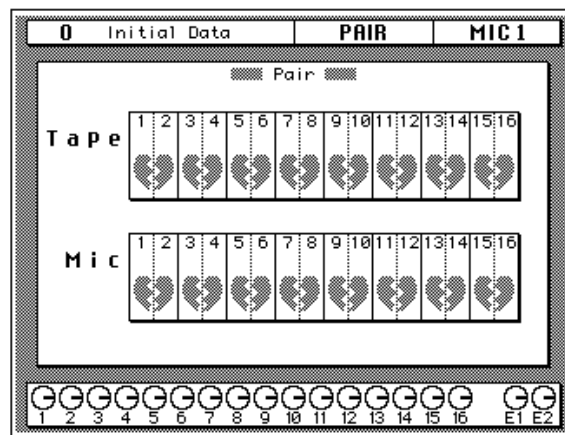

Use the CURSOR buttons to select a channel pair and press the [ENTER] button to pair or separate them.

Another method of pairing channels is to press and hold the [SEL] button of the first channel and then press the [SEL] button for the adjacent channel. The 02R will request you confirm the operation as shown below:

Note: When you create a channel pair, all the parameters from the odd channel are copied to the even channel, overwriting the existing even channel settings.

Auxiliary Pair Display Screen

Shown below is the second PAIR display function - the Aux Pair screen. You can pair the auxiliary send channels – AUX 1 through AUX 6:

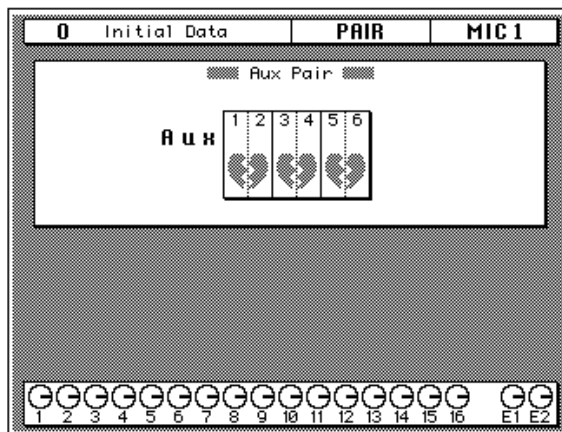

Use the CURSOR buttons to select a channel pair and press the [ENTER] button to pair or separate them.

12

Digital I/O, Setup, and Utilities

12

In this chapter...

Word Clock Select	154
Input Signal Select	156
Cascade Configuration	157
Dither	159
Solo	160
Preferences	162
Oscillator	165
Emphasis Monitor	166
Channel Status Monitor	167
Battery Check	169
02R System Initialization	170

Word Clock Select

1. Press the (DIGITAL I/O) button.



A DIGITAL I/O display function appears. The “Word Clock Select” screen is the first of many screens in this function.

Note: The 02R always recalls the last function visited (and the screen of that function) even after you turn the power off and back on again.

You may have to press the (DIGITAL I/O) button repeatedly to get to the “Word Clock Select” screen.

2. Use the CURSOR buttons to select a wordclock source and press the (ENTER) button.

The Digital Recording Console 02R processes audio data at 44.1 kHz or 48 kHz using its internal clock, and can run at any frequency from 32 kHz -6% to 48 kHz +6% when an external wordclock is applied.

Wordclock

When you connect a number of digital audio devices together, all the devices should synchronize to one device – the wordclock master. The wordclock master generates a sync pulse which allows the other devices connected to it to determine where the start of each digital word is. Although most digital interconnect protocols are self-clocking, it is more reliable to use a dedicated line for your wordclock signal. This is especially important in a multitrack environment where up to eight channels of digital data may be multiplexed on one cable.

When you are using a digital device – such as a DAT mastering recorder or a modular digital multitrack recorder – connected to the 02R, all the digital devices in the system, including the 02R, should synchronize the wordclock being supplied by one master device. If any device does not synchronize to the system wordclock, dropout and/or other noise may occur.

In Section 13, “Installing Options” on page 171 of the *User’s Guide*, there are examples of connecting external digital devices to the 02R and setting the appropriate wordclock selection. Refer to this section for details for each of the optional digital I/O cards.

Note: Wordclock is not required if you use the analog I/O card (CD8-AD) to connect to an analog multitrack recorder.

Display Screen

Shown below is the first DIGITAL I/O display function – the Word Clock Select screen:

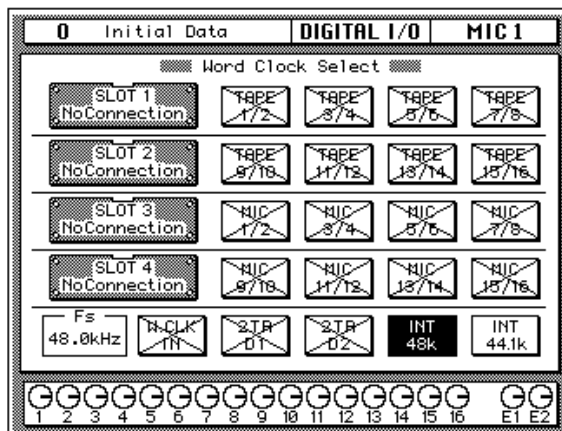

The left side of the display is a list of the cards in the four option slots of the 02R. The indication varies depending on the type of optional card being used:

- Cascade (CD8-CS)
- ADAT (CD8-AT)
- TDIF-1 (CD8-TDII)
- AES/EBU (CD8-AE/CD8-AE-S)
- YAMAHA (CD8-Y)
- Analog AD/DA (CD8-AD)
- No Connection

Beside each optional slot indicator is a row of four boxes defining the connections to the card inserted in the corresponding slot.

Note: *When a cascade card is inserted in any slot, the boxes defining the connections remain on the screen. However, you cannot select any of these items.*

Across the bottom of the display are boxes for the external wordclock (W.CLK IN), the digital inputs (2TR D1 and 2TR D2), and the internal wordclock (INT 48k and INT 44.1k). To the left of the boxes are the wordclock indicators.

There is also an indicator – inside the “Fs” box – that shows the current wordclock frequency or status.

Wordclock indicators



No wordclock input.



Wordclock input. However, the input wordclock frequency is different from that of the selected wordclock.



Wordclock input. No discrepancy between the input and selected wordclock frequencies.



Wordclock input is selected. The 02R is synchronized to the input wordclock frequency.



The wordclock input is selected, but the wordclock signal is inappropriate.



Input Signal Select

1. Press the (DIGITAL I/O) button.



A DIGITAL I/O display function appears.

You may have to press the (DIGITAL I/O) button repeatedly to get to the "Input Signal Select" screen.

2. Use the CURSOR buttons to select the desired control icons. Change the setting by pressing the (ENTER) button.

Note: If there is no digital I/O card or signal present when you select a digital input, the default analog selection will not be changed.

The 02R has 24 built-in analog input connectors; the individual input channels (MIC/LINE 1 through 16) and the stereo input channels (LINE 17/18 through 23/24). You can route two of the 2-track digital inputs to the stereo input channels (2TR IN D1 to LINE 17/18 and 2TR IN D2 to LINE 19/20). You can also convert the individual input channels (MIC/LINE 1 through 16) to tape return channels, allowing you to perform 32-track mixdowns with the 02R.

Display Screen

Shown below is the second DIGITAL I/O display function – the Input Signal Select screen:

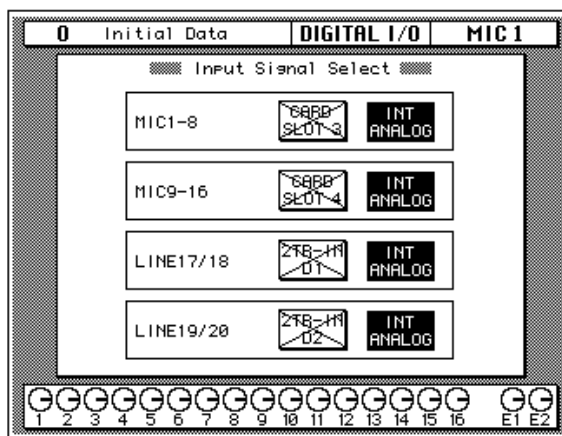

There are four boxes on this screen:

The first box is for MIC 1-8 (MIC/LINE 1 through 8). You can select "CARD SLOT 3" or "INT ANALOG" (the default). If there is no digital I/O card in slot 3, the selection will fail.

The second box is for MIC 9-16 (MIC/LINE 9 through 16). You can select "CARD SLOT 4" or "INT ANALOG" (the default). If there is no digital I/O card in slot 4, the selection will fail.

The third box is for LINE 17/18. You can select "2TR-IN D1" or "INT ANALOG" (the default). If there is no digital signal (no wordclock present) at the 2TR IN DIGITAL connector #1, the selection will fail.

The fourth box is for LINE 19/20. You can select "2TR-IN D2" or "INT ANALOG" (the default). If there is no digital signal (no wordclock present) at the 2TR IN DIGITAL connector #2, the selection will fail.

Note: You cannot select 2TR-IN D1 or 2TR-IN D2 for digital input/output if the corresponding switch (2TR-D1 or 2TR-D2) for either connector has been selected with the CONTROL ROOM monitor switches.

Cascade Configuration

1. Press the (DIGITAL I/O) button.



A DIGITAL I/O display function appears.

You may have to press the (DIGITAL I/O) button repeatedly to get to the “Cascade Configuration” screen.

2. Use the CURSOR buttons to specify which of the internal auxiliary buses the cascade AUX A and AUX B buses will be assigned to.

Press the (ENTER) button to make the selection.

3. Select the “ID” option with the CURSOR buttons and rotate the encoder wheel to specify the cascade ID number.

4. Use the CURSOR buttons to select the cascade input attenuator icons.

Rotate the encoder wheel to change the attenuation level.

5. Select the “2TR-D2 to Stereo Bus” option with the CURSOR buttons and press the (ENTER) button to ENABLE.

Rotate the encoder wheel to change the attenuation level.

Just like the modular digital multitrack recorders it is intended to work with, the 02R was designed to be easily expandable from a basic 16-track (40 input) system up to a 64-track (160 input) system. It uses Cascade Digital I/O card kits (CD8-CS) to accomplish this.

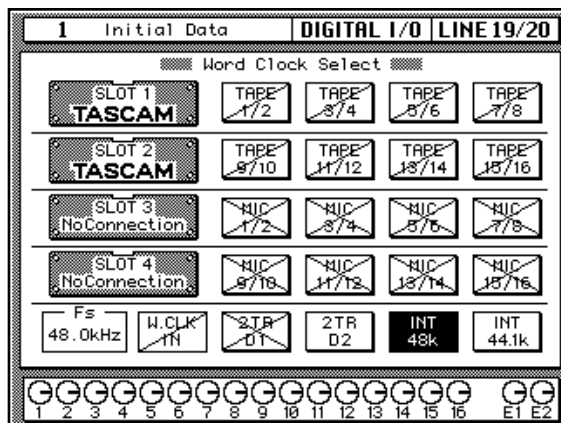

For installation details, see Section 13, “Installing Options” on page 171 of the *User’s Guide*, specifically “Digital Cascade Kit (CD8-CS)” on page 183.

Display Screen

Shown below is the third DIGITAL I/O display function – the Cascade Configuration screen:

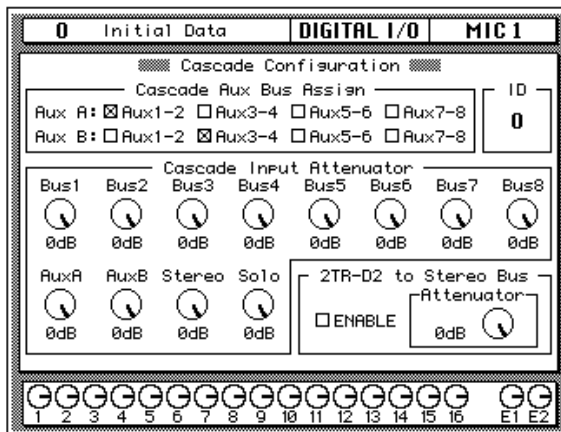

Cascade Aux Bus Assign

The Cascade Digital I/O card kit (CD8-CS) has two paired auxiliary buses: AUX A and AUX B. You can assign these buses to any pair of the 02R's internal auxiliary buses – but not to the same pairs.

If a cascade card is not inserted in the 02R, this display is greyed-out.

ID

The ID value specifies the order in the cascade of this 02R. The first slave unit is assigned 0 (zero). The cascade master is assigned the highest ID value (maximum 3). You can select from 0 to 3 as the unit ID.

You can only set this item when a cascade card is inserted in the 02R and set to IN. When the screen is greyed-out, the ID is automatically set to 0.

Cascade Input Attenuator

These control icons allow you to set the input level of each bus line that is being input into the 02R. You can set the levels for the internal buses 1 through 8, the cascade auxiliary buses (AUX A and AUX B), the stereo bus, and the solo bus.

You can only set this item when a cascade card is inserted in the 02R and set to IN.

2TR-D2 to Stereo Bus

This option allows you to route the 2TR-D2 digital input connector to the stereo bus. You also can set the attenuation level.

Note: *The device plugged into the 2TR-D2 digital input connector must be synchronized to the system wordclock to prevent dropout and/or other noise. You cannot assign the 2TR-D2 to the stereo bus if the corresponding switch (2TR-D2) has been selected with the CONTROL ROOM monitor switches. Select another monitor source before you try to assign this signal to the stereo bus.*

Custom Cascade

The cascade system was designed to be able to connect four 02R's together, but in fact you can actually add even more units if you want. The cascade digital I/O cards were designed to compensate for the signal delay of connecting up to four units together. If you add more units, you will have to compensate for the signal delay with the DELAY display function. See "Delay and Cascade" on page 34 of the *User's Guide* for more details.

Dither

1. Press the (DIGITAL I/O) button.



A DIGITAL I/O display function appears.

You may have to press the (DIGITAL I/O) button repeatedly to get to the "Dither" screen.

2. Use the CURSOR buttons to select the ON/OFF icon for the desired bus and press the (ENTER) button to change the value.
3. Select the Word Length with the CURSOR buttons and press the (ENTER) button.

When you connect a number of digital audio devices together, you may find their digital word size is different. For example, the 02R uses a 20-bit word size for input and output and a 32-bit word size for internal processing. Professional digital equipment uses a 24-bit wordsize, while consumer digital equipment uses a 20-bit wordsize. In order to obtain the best possible signal quality, the 02R has a dither function for its internal bus and stereo bus outputs.

Dithering is a mathematical process where a random noise is added to the least significant bit of a digital word. With very low level signals, the quantization error becomes correlated to the signal level. This creates a small but measurable amount of distortion. By adding dither, the correlation between the signal level and the quantization error is cancelled, allowing the digital system to encode amplitudes smaller than the least significant bit. If you change the word size as a signal passes from one digital system to another, being able to add dither allows you to maintain a high quality signal.

Display Screen

Shown below is the last DIGITAL I/O display function – the Dither screen:

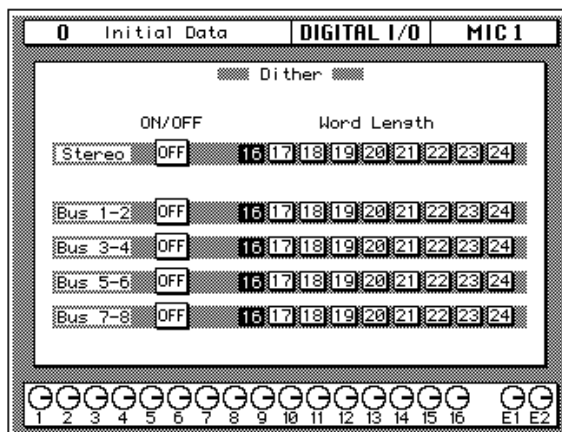

Dither ON/OFF

You can turn the dither function on or off for the stereo bus and for the internal buses 1 through 8. The internal buses are paired for the dither function.

Word Length

You can add dither to compensate for any word size from 16-bit to 24-bit.

Solo

1. Press the (SETUP) button.



SETUP

A SETUP display function appears.

Press the (SETUP) button until the “Solo” screen appears.

2. Use the CURSOR buttons to select the desired “Mode” and press the (ENTER) button.

3. Use the CURSOR buttons to select a “Status” and press the (ENTER) button.

Recording mode:

4. Select a “Listen” point with the CURSOR buttons and press the (ENTER) button.
5. Select the “Solo Level” control icon and adjust the level with the encoder wheel.

Mixdown mode:

6. Use the CURSOR buttons to select the “Solo Safe” channels and press the (ENTER) button to enable/disable the selected channel.

The SETUP display function consists of two screens: the “Solo” screen and the “Preferences” screen.

Display Screen

Shown below is the first SETUP display function – the Solo screen:

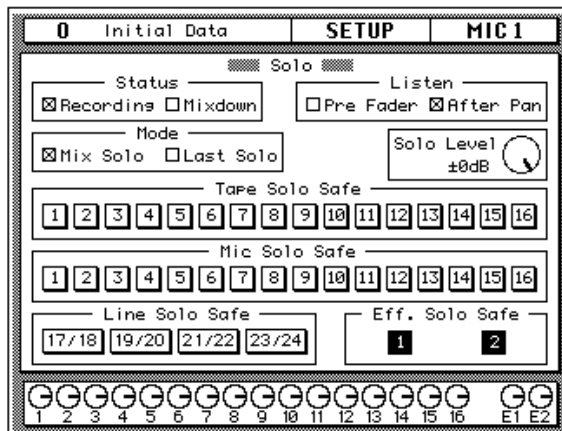

Solo Functions

- **Status** – This command determines which bus will be used when you press the [SOLO] button. If you select “Recording”, the Solo bus will be used. If you select “Mixdown”, the signals selected by the combination of the [SOLO] button and the [ON] buttons will be sent to the Stereo bus, and all other channels will be off.
- **Listen** – This command is only functional in “Recording Mode”. It selects the point the Solo monitoring signal will be taken from. You can select “Pre Fader” or “After Pan” as the monitoring points.

In “Mixdown Mode” the signal is always taken from after the pan and this function is greyed-out.

- **Mode** – This command controls which channels are added to the Solo. If you select “Mix Solo”, all channels that are selected ON will be added to output. If you select “Last Solo”, the channel that was last selected ON will be output.

If you only want to listen to one channel at a time in solo mode, select “Last Solo”.

- **Solo Level** – This rotary icon controls the output level sent to the Solo bus in “Recording Mode”.

In “Mixdown Mode” the signal is sent to the stereo bus and this icon is greyed-out.

- **Solo Safe – Tape, Mic, Line, and Effects** – These functions disable solo On/Off selection. If you set a channel to Solo Safe while it was set to Solo ON, the channel remains unconditionally ON in “Mixdown Mode” when you select Solo.

This function has no effect in “Recording Mode”.

How to use Solo

1. Press the (SOLO) button.

The LEDs inset in all the [ON] buttons start flashing.

2. Press the (ON) buttons for the channels you want to solo.

The LED inset in the [ON] button you select is illuminated steadily. If you selected “Last Solo” in the Status command, only the last channel you select will be soloed.

3. Press the (SOLO) button again to cancel the solo function.

Preferences

1. Press the (SETUP) button until the “Preferences” screen appears.



SETUP

2. Use the CURSOR buttons to select a preference option.
3. Enable or disable the preference option by pressing the (ENTER) button.

The Digital Recording Console 02R is a very flexible mixer. You can customize its behaviour to suit your needs using the preferences options.

Display Screen

Shown below is the second SETUP display function – the Preferences screen:

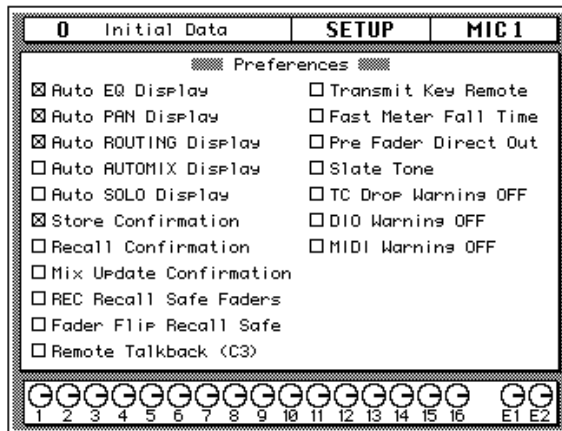

Preferences Options

- **Auto EQ Display** – With this option selected, when you operate the buttons or controls in the SELECTED CHANNEL – EQUALIZER group, the EQUALIZER display function will be automatically recalled on the screen.
- **Auto PAN Display** – With this option selected, when you operate the buttons or controls in the SELECTED CHANNEL – PAN group, the PAN display function will be automatically recalled on the screen.
- **Auto ROUTING Display** – With this option selected, when you operate the buttons in the SELECTED CHANNEL – ROUTING group, the ROUTING display function will be automatically recalled on the screen.
- **Auto AUTOMIX Display** – With this option selected, the AUTOMIX display function will be automatically recalled when the 02R stops automix recording.
- **Auto SOLO Display** – With this option selected, the “Solo” screen of the SETUP display function will appear when you press the [SOLO] button.
- **Store Confirmation** – With this option selected, the 02R will request you confirm any scene memory or library store operation. It is selected ON when the 02R is set to its factory defaults.

You should leave this option in its default state when your 02R is going to be operated by an inexperienced person. Forcing them to respond to a confirmation message may prevent the accidental loss of your valuable data.

When you confirm a STORE operation, any existing data in the selected program location will be overwritten.

YOU SHOULD ALWAYS BE CAREFUL WHEN THE 02R DISPLAYS ITS CONFIRMATION POPUP MESSAGE!

- **Recall Confirmation** – With this option selected, the 02R will request you confirm any scene memory or library recall operation.
- **Mix Update Confirmation** – With this option selected, the 02R will request you confirm saving the update of the current data, or the ABORT command, when an AUTOMIX recording is completed.
- **REC Recall Safe Fader** – With this option selected, you can record fader movement events during an AUTOMIX recording even though the faders were set to Recall Safe.
- **Fader Flip Recall Safe** – With this option selected, the status of the [FLIP] button is not recalled when you recall a scene memory. When you recall a scene memory, the status of the [FLIP] button remains as it was before the scene memory was recalled.
- **Remote Talkback (C3)** – With this option selected, you can enable the Talkback system by sending a MIDI Note On message for C3. You disable the Talkback system by sending a MIDI Note Off message for C3.
- **Transmit Key Remote** – With this option selected, when you operate any buttons, controls, or faders, the 02R will transmit system exclusive parameter change messages from its MIDI OUT connector. This is intended to be used to remotely control another 02R. This option is cancelled when the 02R is turned off.
- **Fast Meter Fall Time** – With this option selected, the level meters will respond more quickly to level changes. When the option is not selected, the level meters delay their fall in order to allow you to see the level changes more clearly.
- **Pre Fader Direct Out** – With this option selected, the signal being sent to the direct outputs will bypass the faders.
- **Slate Tone** – With this option selected, when you press the [SLATE] button, a 50 Hz tone at -34 dB is recorded along with the talkback input.
- **TC Drop Warning OFF** – With this option selected, the 02R will not report a warning when the timecode reader detects a frame dropout.

If you have a noisy connection to your timecode source, or it was poorly recorded on an analog recorder, this message may appear on the screen so often that it becomes distracting. However, if you know your timecode source is reliable, you may want to leave this option off so that the 02R can warn you of any undesirable timecode events.

- **DIO Warning OFF** – With this option selected, the 02R will not report a warning when an error is detected in the digital signals being input from one of the digital I/O cards. When the 02R detects an error, the message “DIGITAL I/O Error!” is flashed on the display.

If you have a poor connection to your modular digital multitrack recorder or any other digital audio devices, this message may appear on the screen so often that it becomes distracting. You should be aware that if the 02R detects an error in the digital input or output, your recorded data may be compromised. However, some modular digital multitrack recorders will cause this error while performing synchronization during start-up.

- **MIDI Warning OFF** – With this option selected, the 02R will not report a warning when it receives a MIDI error.

The following error conditions will not be reported: “Byte Count Error!”, “Check Sum Error!”, “Code Mismatch!”, “ID Mismatch”, and “MIDI Ch Mismatch”.

Preferences – Factory Settings

Option / Setting		Option / Setting	
Auto EQ Display	ON	Transmit Key Remote	OFF
Auto PAN Display	ON	Fast Meter Fall Time	OFF
Auto ROUTING Display	ON	Pre Fader Direct Out	OFF
Auto AUTOMIX Display	OFF	Slate Tone	OFF
Auto SOLO Display	OFF	TC Drop Warning OFF	OFF
Store Confirmation	ON	DIO Warning OFF	OFF
Recall Confirmation	OFF	MIDI Warning OFF	OFF
Mix Update Confirmation	OFF		
REC Recall Safe Fader	OFF		
Fader Flip Recall Safe	OFF		
Remote Talk Back (C3)	OFF		

Oscillator

1. Press the (UTILITY) button.



A UTILITY display function appears.

Press the (UTILITY) button repeatedly to get to the “Oscillator” screen.

2. Use the CURSOR buttons to select the ON or OFF icon and press the (ENTER) button.
3. Select the “Level” control icon with the CURSOR buttons. Rotate the encoder wheel to set the oscillator output level.
4. Use the CURSOR buttons to select the “Wave Form” and press the (ENTER) button.
5. Select the output assignment icons with the CURSOR buttons and press the (ENTER) button for each output.

Before starting a recording session, many engineers like to record a few seconds of sine wave tones. These tones are used to compare the performance of multitrack recorders when you take the master tapes from one studio to another. This is especially important when the multitrack recorder is analog. The O2R has an oscillator function that allows you to send 100 Hz, 1 kHz, and 10 kHz sine waves and white noise to the auxiliary and output buses and the stereo bus.

Display Screen

Shown below is the first UTILITY display function – the Oscillator screen:

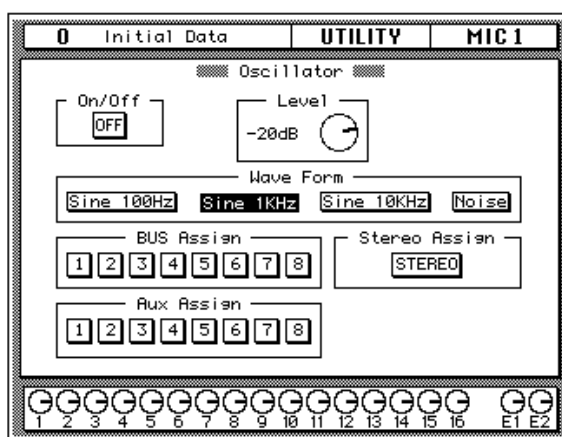

Oscillator Functions

- **ON/OFF** – This icon is selected to turn the oscillator on or off. When the oscillator is on, the Control Room DIM (mute) function is automatically turned on.
- **Level** – This rotary icon allows you to set the oscillator output level. Set the level from -96 dB to 0 dB. Watch the level meters to ensure you are not driving the O2R into digital clipping.
- **Wave Form** – These icons allow you to select the wave form you want output. The O2R can generate four different wave forms: “Sine 100Hz”, “Sine 1kHz”, “Sine 10kHz”, and “Noise”.
- **BUS Assign** – Select the output buses 1 through 8.
- **Stereo Assign** – Select the stereo bus.
- **Aux Assign** – Select the auxiliary buses 1 through 8.

Emphasis Monitor

1. Press the (UTILITY) button.



UTILITY

A UTILITY display function appears.

Press the (UTILITY) button repeatedly to get to the "Emphasis Monitor" screen.

This function allows you to monitor the emphasis information of the digital inputs. If an input digital signal was recorded with emphasis – a technique used in early digital recordings to compensate for the deficiencies of the hardware of the period, similar to Dolby® or dbx® noise reduction for analog – the 02R can compensate by applying de-emphasis to the signal before further processing.

Note: When the 02R receives data that has been processed with emphasis ON, it will automatically process the data by applying de-emphasis. It will continue processing the signal internally and will subsequently output the data with emphasis OFF. Regardless of whether a signal has been received with emphasis ON, the 02R will always output the signal with emphasis OFF.

Display Screen

Shown below is the second UTILITY display function – the Emphasis Monitor screen:

0	Initial Data	UTILITY	MIC 1
Emphasis Monitor			
SLOT 1 NoConnection	TAPE 1/2	3/4	5/6 7/8
SLOT 2 NoConnection	TAPE 9/10	11/12	13/14 15/16
SLOT 3 NoConnection	MIC 1/2	3/4	5/6 7/8
SLOT 4 NoConnection	MIC 9/10	11/12	13/14 15/16
2TR IN DIGITAL	2TR D1	2TR D2	2TR D3

This screen allows you to monitor the emphasis information of the signal input from each digital input jack of optional slots 1-4 and 2TR DIGITAL IN 1-3 connectors. One of the following three icons will appear depending on the status of the input signal:



No signal or an invalid signal is being input.

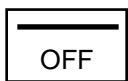

Valid digital audio signal is being input. De-emphasis is not required and is off for the signal.



Valid digital audio signal is being input. De-emphasis is required and is set to on for the signal.

Channel Status Monitor

1. Press the (UTILITY) button.



A UTILITY display function appears.

Press the (UTILITY) button repeatedly to get to the "Channel Status Monitor" screen.

2. Use the CURSOR buttons to select an input signal – "SLOT1", "SLOT2", "SLOT3", "SLOT4", or "2TR" – and press the (ENTER) button.

If applicable, the O2R will show the channel status information for the selected input.

This function shows the channel status information of digital audio signal. Channel status information is only present in IEC958 digital audio interconnect signals.

Display Screen

Shown below is the third UTILITY display function – the Channel Status Monitor screen:

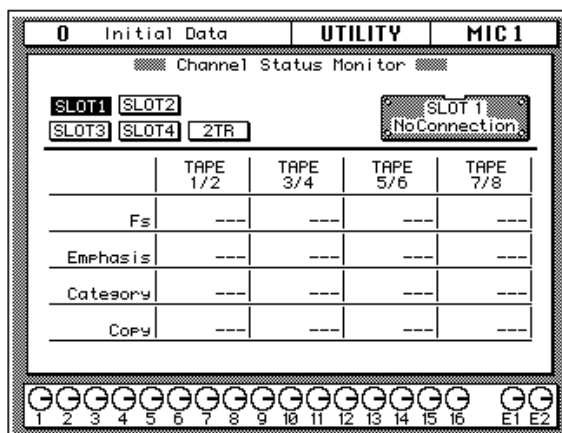

This screen allows you to monitor the channel status information from a digital audio signal using the IEC958 Part3 (AES/EBU – Professional) format or IEC958 Part2 (Consumer) format.

Check one of the [SLOT1], [SLOT2], [SLOT3], [SLOT4], and [2TR] check boxes shown in the upper part of the screen to select the information you wish to monitor. If you select one of SLOTS 1-4 and any card other than the CD8-AE (AES/EBU card) has been installed in the corresponding slot (or no card is installed), the screen becomes grey and you cannot monitor the information.

The table in the center of the screen shows the contents of the channel status of the selected signal.

Each indication has the following meaning:

- **Fs** – This is the sampling frequency information. One of "32k", "44.1k", "48k", "None" (unknown), and "(UNLOCK)" will appear.
"(UNLOCK)" means that no signal is being input or the input signal is invalid. In this case, the Emphasis, Category, and Copy columns will show "---".
- **Emphasis** – This shows the status of emphasis of the control bit. "ON", "OFF" or "???" (unknown) will be shown.

- **Category** – This shows the status of the “category bit” which is implemented only for the IEC958 Part2 (Consumer) format. The following items are included:

General – Used temporarily.

Laser Optical – Laser optical device

D/D Conv – Digital-to-digital converter and signal processor

Magnetic – Magnetic tape device and magnetic disk device

D. Broadcast – Digital broadcast reception

Instruments – Musical instruments, microphones and the sources that generate the original signal

A/D Conv – A/D Converter (Without copyright information)

A/D Conv with (C) – A/D Converter (With copyright information)

Solid Memory – Solid memory device

Experimental – Experimental device

Unknown – Unknown

Note: *If you monitor a signal in the IEC958 Part3 (AES/EBU – Professional) format (which does not have a category code bit), the Category column will show “AES/EBU”.*

- **Copy** – This shows the status of “C bit” (Copyright information) that has been implemented in only the IEC958 Part 2 (Consumer) format. The following items will be shown:

Ok – Copy allowed.

Prohibit – Copy prohibited.

Note: *If you monitor a signal in the IEC958 Part3 (AES/EBU – Professional) format (which does not have a “C” bit), the Copy column will show “---”.*

Battery Check

1. Press the (UTILITY) button. This function allows you to check the status of the memory back-up lithium battery inside the 02R.



UTILITY

A UTILITY display function appears.

Press the (UTILITY) button repeatedly to get to the "Battery Check" screen.

Display Screen

Shown below is the fourth UTILITY display function – the Battery Check screen:

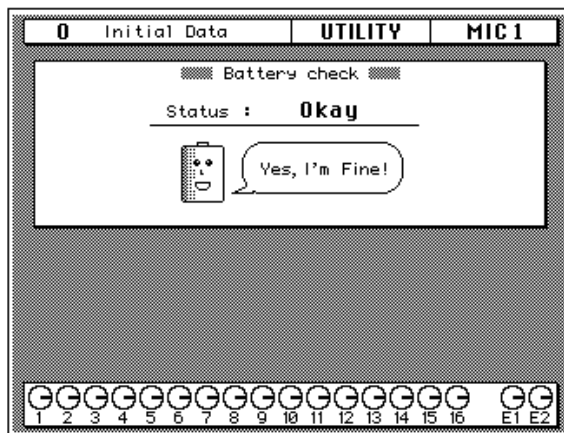

If there is enough battery capacity, the screen shown above will appear.

If the battery needs to be changed, the screen shown below will appear:

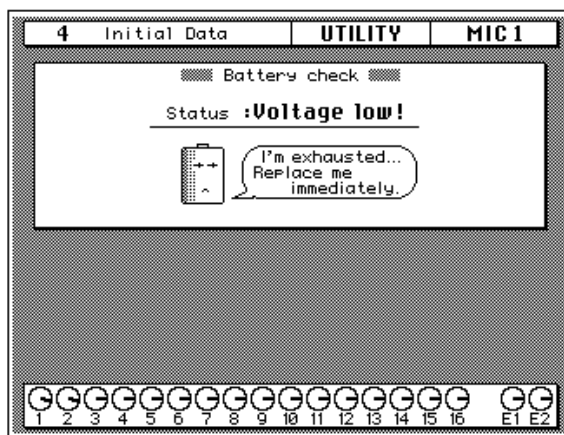

Note: If this screen appears, your important data in memory, such as scene memories, automix memories, and libraries, may be lost. Ask your nearest Yamaha dealer or Yamaha Service Center to replace the battery as soon as possible.

02R System Initialization

1. Turn the 02R power off.
2. Press and hold the left CURSOR button.

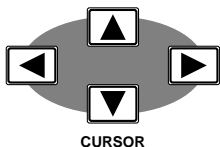

3. Turn the 02R power back on.

A confirmation popup message appears.

4. Select the EXECUTE icon by with the CURSOR buttons and press the (ENTER) button.

The 02R will initialize itself back to its factory default settings. When it has completed the initialization operation, the SCENE MEMORY display function will appear on the screen.

This operation allows you to reset the Digital Recording Console 02R to its factory default settings. This operation deletes all scene memories, automix programs, and clears all user library programs from the channel, dynamics, effect, and equalizer libraries.

Note: If you just want to reset the current mix settings, recall Scene Memory 0. See “Initial Data and UNDO Memory” on page 115 of the User’s Guide.

Initialization consists of:

- Clearing all user RAM settings: all scene memories (except Scene Memory 0), automix programs, and user library programs from the channel, dynamics, effect, and equalizer libraries.
- Initializing the Edit Buffer. See “What is the Edit Buffer?” on page 115 of the User’s Guide.
- Initializing the Program Change table (list of scene memories to MIDI Program Change numbers). See “Program Change Assign” on page 144 of the User’s Guide.
- Coping Scene Memory 0 to the Edit Buffer.
- Initializing the input and output ports.
- Calibrating the faders.

Note: Avoid blocking the fader movements by placing objects on the 02R while the faders are calibrating themselves. It is possible to damage the faders.

- Refreshing the display screen.

The SCENE MEMORY display function will appear on the screen.

Fader Calibration

This operation allows you to calibrate the faders.

1. Turn the 02R power off.
2. Press and hold the (ENTER) button, then turn the 02R power back on.

The faders will calibrate themselves.

Note: Avoid blocking the fader movements by placing objects on the 02R while the faders are calibrating themselves. It is possible to damage the faders.

13

Installing Options

13

In this chapter...

Digital Recording Console 02R Options.	172
Installing 02R Options	175
Analog I/O Card – AD/DA (CD8-AD)	178
Digital I/O Card – AES/EBU (CD8-AE/CD8-AE-S)	179
Digital I/O Card – ADAT (CD8-AT)	181
Digital Cascade Kit (CD8-CS)	183
Digital I/O Card – TDIF-1 (CD8-TDII)	187
Peak Meter Bridge (MB02)	189

Digital Recording Console 02R Options

There are a number of options you can add to your Digital Recording Console 02R. Some of these options add to the convenience and appearance of the 02R, such as the peak meter bridge (MB02) or the wooden side panels (W02SP). There is also a memory expansion kit (ME4M) which allows you to add up to 2 MB of additional memory for the automation system.

The most important options are the I/O cards.

These cards support direct digital interconnection to the latest generation of modular digital multitrack recorders. Alesis ADAT, TASCAM TDIF-1, YAMAHA, and AES/EBU cards are available.

In addition, you can insert a Digital Cascade card into one of the I/O slots, allowing you to cascade multiple 02Rs together to create a larger digital mixing system.

An analog card is also available to allow you to connect to an analog multitrack recorder.

02R Options

Type	Product	Format
Analog I/O Card	CD8-AD	AD/DA
	CD8-AE	AES/EBU
Digital I/O Card	CD8-AE-S	AES/EBU
	CD8-AT	ADAT
	CD8-TDII	TDIF-1
	CD8-Y	YAMAHA
	CD8-CS	
Digital Cascade Kit	CD8-CS	
Peak Meter Bridge	MB02	
Memory Expansion Kit	ME4M	
Wooden Side Panels	W02SP	

I/O Cards

The I/O cards transmit and receive signals between your 02R and external devices, such as modular digital multitrack recorders, hard disk recorders, analog multitrack recorders, or other 02R's. The cards come in two sizes (form factors), single slot and double slot:

- Single slot I/O cards can be installed in any slot from 1 through 4.
- Double slot I/O cards can only be installed in slots 1 or 2.

The I/O cards fall into three groups:

- **Digital I/O Cards** – These cards provide 8 tracks of digital input and output. They are used to connect the 02R to a digital multitrack recorder – either tape or disk based. Cards supporting ADAT, TDIF-1, YAMAHA, and AES/EBU formats are available. Except for the CD8-AE card, these cards are single slot, allowing you to insert up to four cards giving you a maximum 32 tracks of digital mixdown.
- **Analog I/O Card** – This card provides 8 tracks of analog input and output. It can be used to connect the 02R to an analog multitrack recorder or to expand the analog inputs and outputs of the mixer. Conversion is performed in 20-bit linear. The sampling frequency is the same as the current wordclock master on the 02R.
- **Cascade I/O Card** – This card allows you to connect the bus lines 1 through 8, two pairs of the auxiliary buses 1 through 8 to the cascade card's AUX A and AUX B buses, the STEREO bus, and the SOLO bus of two or more 02R's. One 02R is the cascade master, the others are slaves.

The following table lists the I/O cards available:

Card	Format	Product	Size & Location
Digital I/O	AES/EBU	CD8-AE	double – slots 1 or 2 (max 2 cards – 16 ch)
		CD8-AE-S	single – all slots 1 through 4 (max 4 cards – 32 ch)
	ADAT	CD8-AT	single – all slots 1 through 4 (max 4 cards – 32 ch)
	TDIF-1	CD8-TDII	single – all slots 1 through 4 (max 4 cards – 32 ch)
	YAMAHA	CD8-Y	single – all slots 1 through 4 (max 4 cards – 32 ch)
Analog I/O	AD/DA	CD8-AD	double – slots 1 or 2 (max 2 cards – 16 ch)
Cascade Kit		CD8-CS	single – kit incl. 2 cards & connecting cable. slots 1 through 4 (normally 3 or 4)

Peak Meter Bridge

The Peak Meter Bridge (MB02) displays the levels for all the input, output, and bus channels of the 02R, plus it duplicates the stereo output signal levels. The meter bridge duplicates the information shown in the METER display function in a much more convenient form.

Memory Expansion Kit

The memory expansion kit (ME4M) expands the 02R automation system memory from the standard 512 Kbytes to either 1.5 Mbytes or 2.5 Mbytes.

Note: *You cannot install the Memory Expansion Kit ME4M without invalidating the warranty. Take your 02R to your YAMAHA dealer or authorized service centre for installation of the ME4M kit.*

Wooden Side Panels

These Wooden Side Panels (W02SP) attach to either side of the 02R to give it an attractive appearance.

Installing 02R Options

Single Slot Cards

1. Turn OFF the power to the 02R by pressing the POWER switch on the back panel.

TO PREVENT ELECTRICAL SHOCK, ENSURE THE 02R IS POWERED OFF BEFORE YOU OPEN ANY OF THE OPTIONAL SLOT COVERS!

Note: Before you install a card in the 02R, be certain to turn the power off. Not only do you risk electrical shock, you can also damage either the 02R or the optional card. You will also invalidate any warranties for the Digital Recording Console 02R or the optional cards.

2. Remove the cover plate from the slot in which you intend to insert the optional card.

Note: You should save the cover plates for possible later use. You should also never operate the 02R with one of the slots uncovered. This disrupts the flow of air through the power supply and other components and can cause premature failure of internal components.

3. Insert the optional card as shown in the diagram:

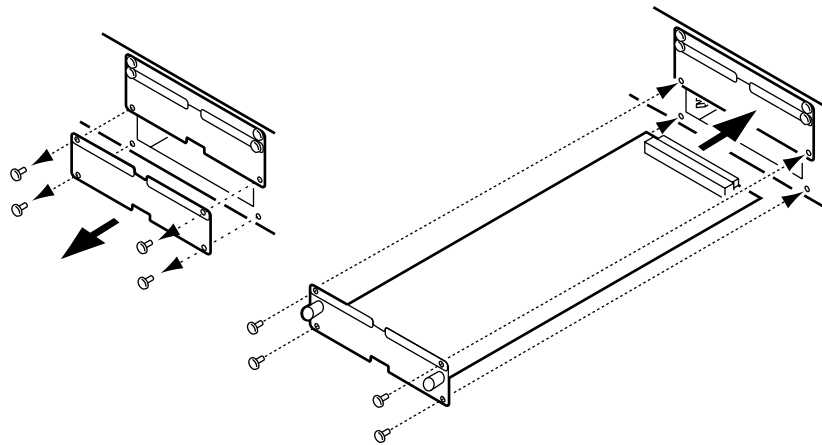

When you insert the card, press it firmly into the slot to make certain the connector on the card edge seats firmly on the bus slot inside the 02R. Make sure the card is properly secured with the screws that held the cover plate in place.

4. Turn ON the power to the 02R.

Verify that the card has been recognized by the system software by pressing the [DIGITAL I/O] button until the "Word Clock Select" screen appears (see "Word Clock Select" on page 154 of the *User's Guide*). If the card was installed properly, the system software should correctly identify it in the appropriate slot.

Double Slot Cards

1. Turn OFF the power to the 02R by pressing the POWER switch on the back panel.

TO PREVENT ELECTRICAL SHOCK, ENSURE THE 02R IS POWERED OFF BEFORE YOU OPEN ANY OF THE OPTIONAL SLOT COVERS!

Note: Before you install a card in the 02R, be certain to turn the power off. Not only do you risk electrical shock, you can also damage either the 02R or the optional card. You will also invalidate any warranties for the Digital Recording Console 02R or the optional cards.

2. Remove the cover plate from the slot in which you intend to insert the optional card as well as the slot over top

The double slot cards can only be installed in SLOT1 and/or SLOT2.

Note: You should save the cover plates for possible later use. You should also never operate the 02R with one of the slots uncovered. This disrupts the flow of air through the power supply and other components and can cause premature failure of internal components.

3. Insert the optional card as shown in the diagram:

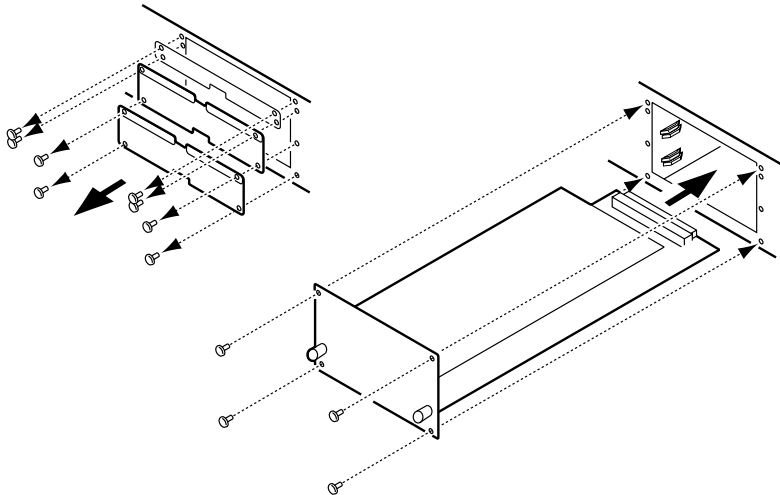

When you insert the card, press it firmly into the slot to make certain the connector on the card edge seats firmly on the bus slot inside the 02R. Make sure the card is properly secured with the screws that held the cover plate in place.

4. Turn ON the power to the 02R.

Verify that the card has been recognized by the system software by pressing the [DIGITAL I/O] button until the "Word Clock Select" screen appears. If the card was installed properly, the system software should correctly identify it in the appropriate slot.

Peak Meter Bridge and Wooden Side Panels

1. Turn OFF the power to the 02R by pressing the POWER switch on the back panel.

TO PREVENT ELECTRICAL SHOCK, ENSURE THE 02R IS POWERED OFF BEFORE YOU FASTEN ANY CONNECTORS OR UNDO ANY SCREWS!

Note: Before you install the MB02 on the 02R, be certain to turn the power off. Not only do you risk electrical shock, you can also damage either the 02R or the MB02. You may also invalidate any warranties for the Digital Recording Console 02R or the Peak Meter Bridge (MB02).

2. Install the Peak Meter Bridge and/or Wooden Side Panels as shown in the following diagram:

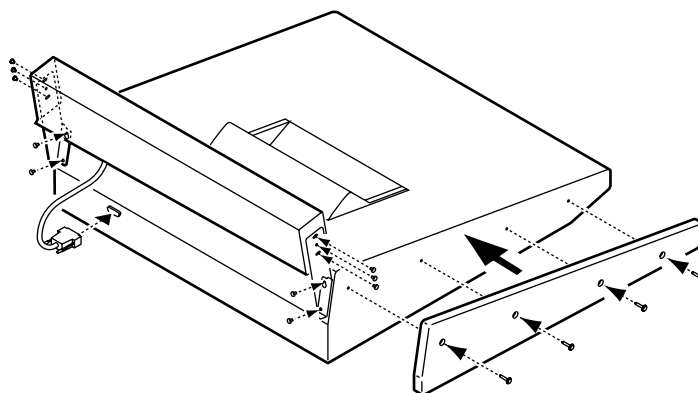

3. Turn ON the power to the 02R.

Verify that the MB02 is functioning correctly.

Memory Expansion Kit

The Memory Expansion Kit (ME4M) is a dealer/service center installed option only. Any attempt by a customer to install this option will invalidate any warranties for the Digital Recording Console 02R or the ME4M.

Please take your 02R to your YAMAHA dealer or a YAMAHA service centre to have the Memory Expansion Kit (ME4M) installed in the unit.

Analog I/O Card – AD/DA (CD8-AD)

The analog I/O card (CD8-AD) is used to connect an analog multitrack recorder or other analog devices to the 02R.

Installing the CD8-AD

The analog I/O card (CD8-AD) is a double slot card. For installation instructions, see “Double Slot Cards” on page 176 of the *User’s Guide*. Before you install the CD8-AD, you need to set the individual input and output levels for the connectors in the card. Set the switches to –10dBv or +4dB as appropriate for the input or output levels of your analog multitrack recorder or other analog devices.

Refer to the sheet included with the CD8-AD for more information about the level switches.

Setup of the CD8-AD

- 1. Press the (DIGITAL I/O) button until the “Word Clock Select” screen appears.**

If the card was installed properly, the system software should correctly identify it in the appropriate slot.

- 2. Make the required connections between the 02R and your analog devices.**

You should use the highest quality connecting cables you can afford to maintain the best possible signal quality.

Digital I/O Card – AES/EBU (CD8-AE/CD8-AE-S)

The AES/EBU digital I/O cards (CD8-AE/CD8-AE-S) are used to connect AES/EBU compatible multitrack digital recorders or other similar digital devices to the 02R.

Installing the CD8-AE/CD8-AE-S

The CD8-AE card is a double slot card (see “Double Slot Cards” on page 176). The CD8-AE-S card is a single slot card (see “Single Slot Cards” on page 175).

1. Connect the AES/EBU compatible multitrack digital recorder to the 02R using the appropriate connectors.

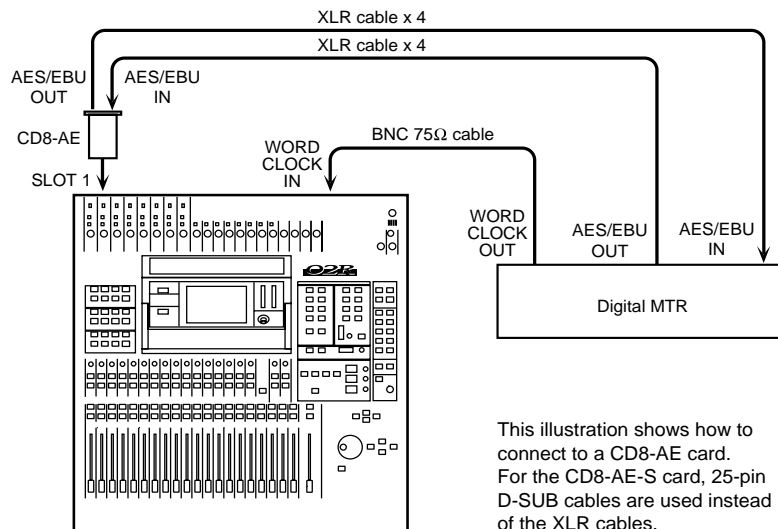

Use high quality 110Ω digital connecting cables to connect to the CD8-AE card. Use 25-pin D-SUB cables that are suitable for digital audio use to connect to the CD8-AE-S card.

2. If your AES/EBU compatible multitrack digital recorder has a dedicated wordclock output connector, plug it into the WORD CLOCK – IN connector on the back of the 02R and turn the 75Ω terminator switch on.

If there is no dedicated wordclock output, you can obtain the wordclock signal required from one of the digital interconnect lines.

Note: A dedicated wordclock line will give you the best wordclock synchronization results.

Wordclock Selection

1. Power on your AES/EBU compatible multitrack digital recorder and then the 02R.

It is always important to observe the correct order for powering up equipment in a studio. Start with the AES/EBU compatible multitrack and mastering recorders and the signal processors, then the 02R, and finally the monitoring amplifiers and other downstream gear.

2. Press the (DIGITAL I/O) button until the “Word Clock Select” screen appears.

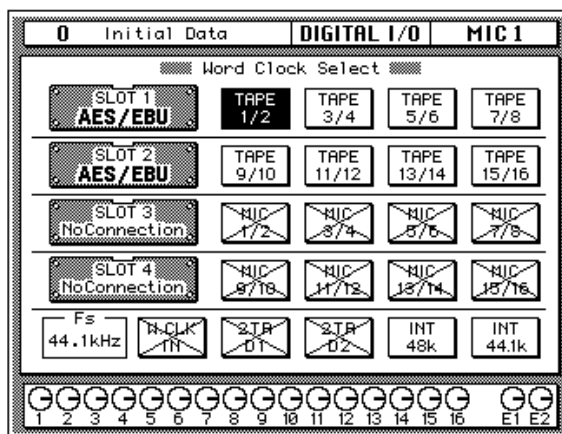

If the card was installed properly, the system software should correctly identify it in the appropriate slot.

3. Use the CURSOR buttons to select the wordclock source.

If your AES/EBU compatible multitrack digital recorder has a dedicated wordclock output connector, use the CURSOR buttons to select the W.CLK IN box and press the [ENTER] button. If the multitrack digital recorder does not have a dedicated wordclock output, select the TAPE 1/2 box – the first box in the SLOT1 row – and press the [ENTER] button.

4. When you select the wordclock source, the appropriate icon should be inverted in reverse video.

See “Word Clock Select” on page 154 of the *User’s Guide* for further details.

Digital I/O Card – ADAT (CD8-AT)

The ADAT digital I/O card (CD8-AT) is used to connect Alesis ADAT compatible modular digital multitrack recorders to the 02R.

Installing the CD8-AT

The ADAT digital I/O card (CD8-AT) is a single slot card. For installation instructions, see “Single Slot Cards” on page 175 of the *User’s Guide*.

1. **Connect the ADAT modular digital multitrack recorder to the 02R using the appropriate connectors.**

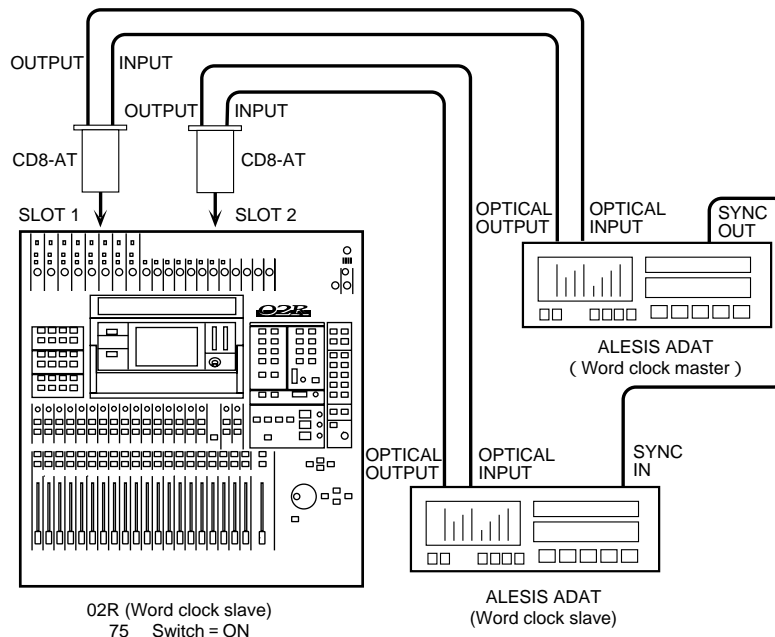

Use the special ADAT optical cables to plug the IN connector of the CD8-AT to the OPTICAL OUT connector of the ADAT modular digital multitrack recorder. Plug the OUT connector of the CD8-AT to the OPTICAL IN connector of the ADAT recorder.

If you have installed more than one CD8-AT in the 02R and have more than one ADAT recorder, connect it in the same manner as the first unit.

2. **The Alesis ADAT modular digital multitrack recorder does not have a dedicated wordclock output connector. If you are using the BRC ADAT remote controller, you can use the 48kHz OUT connector and an appropriate cable to plug it into the WORD CLOCK – IN connector on the back of the 02R and turn the 75Ω terminator switch on.**

If there is no dedicated wordclock output, you can obtain the wordclock signal required from the digital interconnect line.

Note: A dedicated wordclock line will give you the best wordclock synchronization results.

Wordclock Selection

1. Power on your ADAT modular digital multitrack recorder and then the 02R.

It is always important to observe the correct order for powering up equipment in a studio. Start with the ADAT and mastering recorders and the signal processors, then the 02R, and finally the monitoring amplifiers and other downstream gear.

2. Press the (DIGITAL I/O) button until the “Word Clock Select” screen appears.

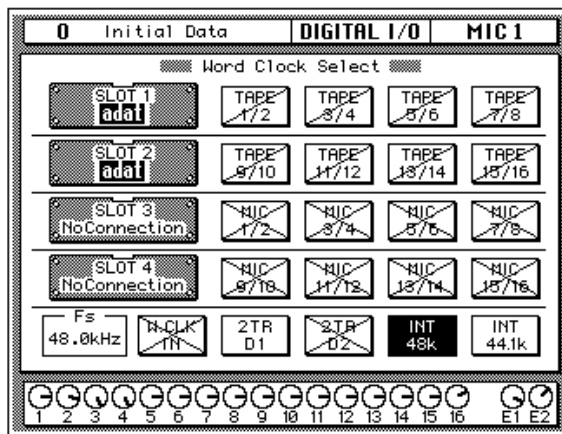

If the card was installed properly, the system software should correctly identify it in the appropriate slot. The ADAT digital I/O card (CD8-AT) can be installed in any slot. You should install the first two cards in SLOT1 and SLOT2 in order to access the direct out lines.

Note: If the W.CLK IN box or the TAPE1/2 box is not showing a proper wordclock input (no discrepancy between the input and selected wordclock frequencies), check the connections between the ADAT modular digital multitrack recorder and the 02R. Check that the ADAT recorder is powered on.

3. Use the CURSOR buttons to select the wordclock source.

If you are using the 48kHz OUT connector from the BRC ADAT remote controller plugged into the WORD CLOCK – IN connector, use the CURSOR buttons to select the W.CLK IN box and press the [ENTER] button. If you are just using an ADAT modular digital multitrack recorder, select the TAPE 1/2 box – the first box in the SLOT1 row – and press the [ENTER] button.

4. When you select the wordclock source, the appropriate icon should be inverted in reverse video.

See “Word Clock Select” on page 154 of the *User’s Guide* for further details.

Digital Cascade Kit (CD8-CS)

The digital cascade kit (CD8-CS) is used to connect two or more Digital Recording Console 02R units together. The kit consists of two cascade I/O cards and a special cable. When two or more 02R units are connected together, they share the output buses 1 through 8, four auxiliary buses (two paired buses, AUX A and AUX B), the stereo bus, and the solo bus.

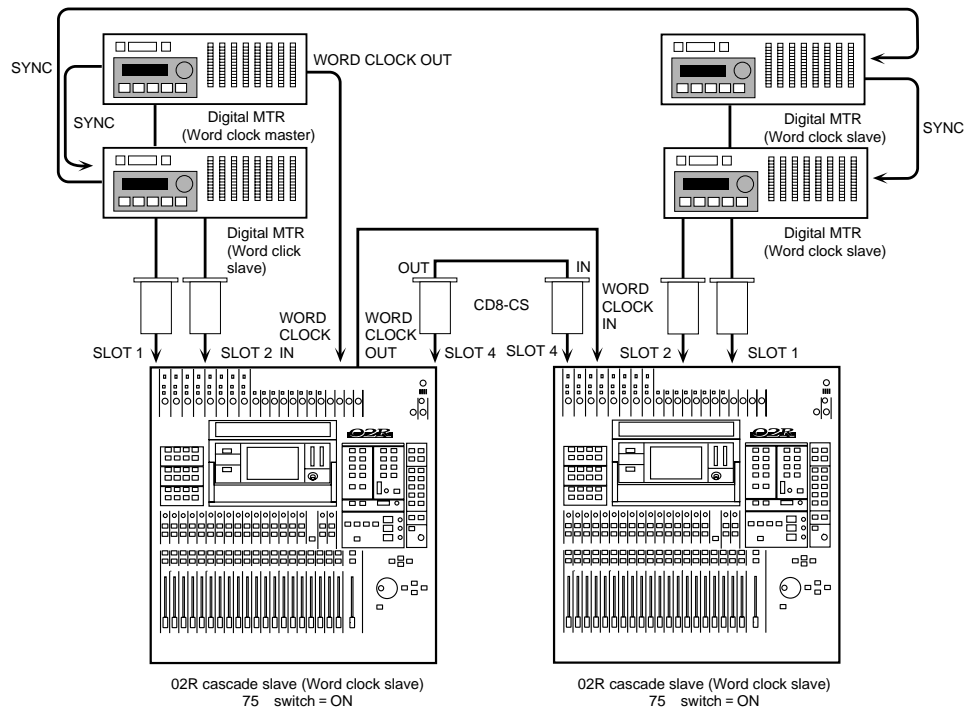

Installing the CD8-CS

The cascade I/O card (CD8-CS) is a single slot card. At least one cascade I/O card should be installed in each 02R. If you are connecting more than two units, the middle units should have two cards. The cascade I/O cards should be installed in SLOT3 or SLOT4. You should reserve SLOT1 and SLOT2 for digital I/O cards.

For installation instructions, see "Single Slot Cards" on page 175 of the *User's Guide*.

1. Set the IN/OUT switch of the cascade I/O card installed in the first 02R to the IN position.

This unit will be the cascade master.

2. Set the IN/OUT switch of the cascade I/O card installed in the second 02R to the OUT position.

This unit will be the cascade slave.

3. Use a BNC cable to plug the WORD CLOCK – OUT connector on the back of the first 02R into the WORD CLOCK – IN connector on the second 02R.

The 02R that is the cascade master should be receiving a wordclock signal from a wordclock master device, such as a modular digital multitrack recorder or other appropriate device.

Wordclock Selection

1. Power on your modular digital multitrack recorder and then the 02R units in order, starting with the cascade master.

It is always important to observe the correct order for powering up equipment in a studio. Start with the multitrack and mastering recorders and the signal processors, then the 02R, and finally the monitoring amplifiers and other downstream gear.

2. On the 02R cascade slave, press the (DIGITAL I/O) button until the “Word Clock Select” screen appears.

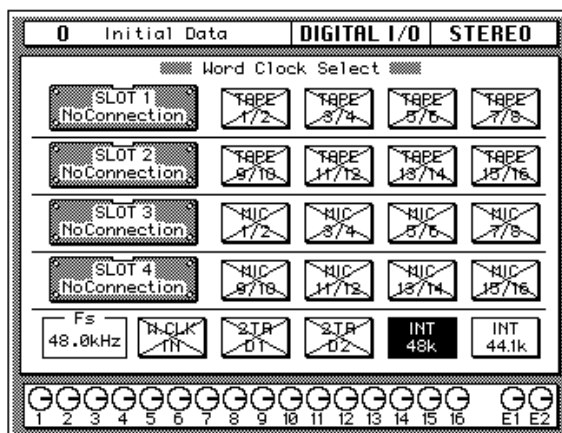

If the cascade I/O card was installed properly, the system software should correctly identify it in the appropriate slot.

3. Use the CURSOR buttons to select the wordclock source.

Select the W.CLK IN box and press the [ENTER] button.

Note: If the W.CLK IN box is not showing a proper wordclock input (no discrepancy between the input and selected wordclock frequencies), check the connections between the 02R units.

4. On the 02R cascade master, press the (DIGITAL I/O) button until the “Word Clock Select” screen appears.

If the cascade I/O card was installed properly, the system software should correctly identify it in the appropriate slot. A digital I/O card should be installed in SLOT1 or SLOT2 in order to access the direct out lines.

5. Use the CURSOR buttons to select the wordclock source.

If your multitrack digital recorder has a dedicated wordclock output connector, use the CURSOR buttons to select the W.CLK IN box and press the [ENTER] button. Otherwise, select a box from the appropriate I/O slot row and press the [ENTER] button.

6. When you select the wordclock source, the corresponding icon should be inverted in reverse video.

See “Word Clock Select” on page 154 of the *User’s Guide* for further details.

Cascade Settings

1. On the 02R cascade master, press the (DIGITAL I/O) button until the “Cascade Configuration” screen appears.**2. Select the “ID” field with the CURSOR buttons and rotate the encoder wheel until the appropriate value is set.**

The cascade master should have the highest ID number in the system. If you have four 02R units cascaded together, the cascade master should be set to ID=3.

Note: *If you connect more than four 02R units together, you will have to adjust the delay to compensate for signal processing time. See “Delay and Cascade” on page 34 of the User’s Guide.*

3. On the 02R cascade slave, press the (DIGITAL I/O) button until the “Cascade Configuration” screen appears.

If the cascade slave and cascade master units are powered on and connected correctly, the ID number for the cascade slave is set to the appropriate value automatically.

4. Use the CURSOR buttons to select the “Cascade Aux Bus Assign” field.

Use the CURSOR buttons to select two pairs of auxiliary buses from the cascade slave to send to the cascade master AUX A and AUX B buses.

Note: *It is not possible to send the same pair of auxiliary buses from the cascade slave to both AUX A and AUX B on the cascade master.*

See “Cascade Configuration” on page 157 of the *User’s Guide* for further details.

Solo function

When two or more 02R units are cascaded together, only the [SOLO] button on the cascade master continues to function. When you press the [SOLO] button on the cascade master, however, you can solo individual channels on the cascade slave units.

1. **On the 02R cascade master, press the (SETUP) button until the “Solo” screen appears.**
2. **Select the “Mode” field with the CURSOR buttons to set the solo function status.**

You can only set this status on the cascade master.

See “Solo” on page 160 of the *User’s Guide* for further details.

3. **On the 02R cascade master, press the (SOLO) button.**

The LEDs inset in the [ON] buttons of all the cascaded 02R units will flash.

4. **Press the (ON) button of the channel (or channels) that you want to solo.**

During recording, the channel signal will be sent to the SOLO bus on the cascade master. You can monitor the signal using the monitor system connected to the cascade master 02R.

At mixdown, the signal will be sent to the STEREO bus.

Digital I/O Card – TDIF-1 (CD8-TDII)

The TDFI-1 digital I/O card (CD8-TDII) is used to connect TASCAM TDFI-1 modular digital multitrack recorders such as the DA-88 to the 02R.

Installing the CD8-TDII

The TDFI-1 digital I/O card (CD8-TDII) is a single slot card. For installation instructions, see “Single Slot Cards” on page 175 of the *User’s Guide*.

1. **Connect the TASCAM DA-88 modular digital multitrack recorder to the 02R using the appropriate connectors.**

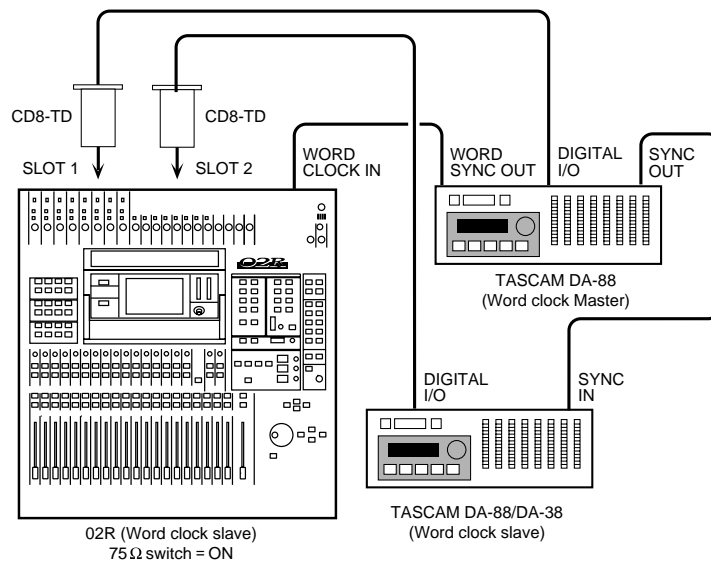

Use the special cable to plug the connector of the CD8-AT to the DIGITAL I/O connector of the TASCAM DA-88 recorder.

If you have installed more than one CD8-TDII in the 02R and have more than one TASCAM DA-88 recorder, connect it in the same manner as the first unit.

2. **The TASCAM DA-88 recorder is equipped with a WORD SYNC OUT connector. Use a BNC cable to plug it into the WORD CLOCK – IN connector on the back of the 02R.**

If you are using more than one TASCAM DA-88 recorder, make the first unit the wordclock master. There are SYNC IN/SYNC OUT connectors on the DA-88 recorders that allow them to run together. DA-38s can not be used as wordclock master, because they do not have a SYNC OUT connector.

Wordclock Selection

1. Power on your DA-88 modular digital multitrack recorder and then the 02R.

It is always important to observe the correct order for powering up equipment in a studio. Start with the DA-88 and mastering recorders and the signal processors, then the 02R, and finally the monitoring amplifiers and other downstream gear.

2. Press the (DIGITAL I/O) button until the “Word Clock Select” screen appears.

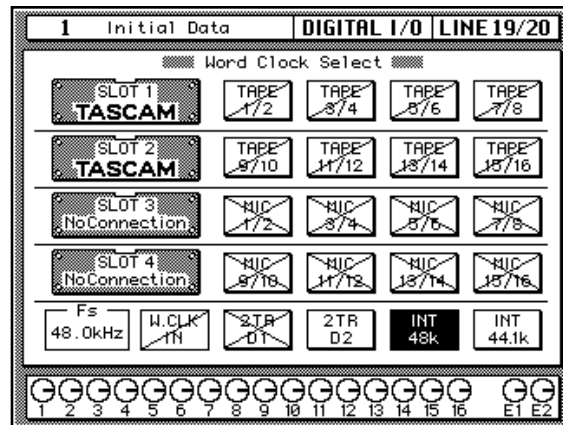

If the card was installed properly, the system software should correctly identify it in the appropriate slot. The TDFI-1 digital I/O card (CD8-TDII) can be installed in any slot. You should install the first two cards in SLOT1 and SLOT2 in order to access the direct out lines.

Note: If the W.CLK IN box is not showing a proper wordclock input (no discrepancy between the input and selected wordclock frequencies), check the BNC cable between the WORD SYNC OUT connector on the DA-88 and the WORD CLOCK IN connector on the 02R. Check that the DA-88 is powered on.

3. Use the CURSOR buttons to select the wordclock source.

Use the CURSOR buttons to select the W.CLK IN box and press the [ENTER] button.

4. When you select the wordclock source, the appropriate icon should be inverted in reverse video.

See “Word Clock Select” on page 154 of the *User’s Guide* for further details.

Peak Meter Bridge (MB02)

The Peak Meter Bridge (MB02) allows you to quickly and easily check the levels of the input channels, the tape and effect returns, the output buses 1 through 8, the auxiliary buses 1 through 8, and the stereo bus.

Using the MB02

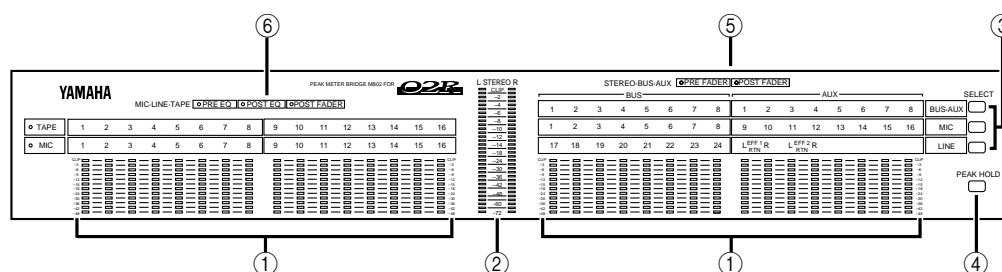

1. Level meters

These peak level meters show the signal level of each input channel (MIC/LINE 1 through 16, LINE 17/18 through 23/24), the tape returns (TAPE 1 through 16), the effect returns (EFF1 and EFF2), the output buses (BUS1 through BUS8), and the auxiliary buses (AUX1 through AUX8).

2. STEREO level meter

This peak level meter shows the level of the stereo bus.

3. SELECT buttons

These buttons are used to select the signal being monitored.

- **BUS/AUX** – When this button is on, the level meters on the right side of the panel will indicate the output levels of the output buses (BUS1 through BUS8), and the auxiliary buses (AUX1 through AUX8).
- **MIC** – When this button is on, the level meters on the left side of the panel will indicate the tape return levels and the meters on the right side of the panel indicate the individual input channel levels (MIC/LINE 1 through 16). If a digital I/O card is installed in SLOT3 and/or SLOT4, the MIC channels can monitor the output from the connected multitrack digital recorder, allowing you to see the levels of tape return channels 17 through 32.
- **LINE** – When this button is on, the level meters on the left side of the panel indicate the individual input channel levels (MIC/LINE 1 through 16). The meters on the right side of the panel indicate the stereo input channels (LINE 17/18 through 23/24) and the effect returns (EFF1 and EFF2).

4. PEAK HOLD button

This button used to enable or cancel the peak hold function of the meters.

Note: *The operation of this button duplicates the function of the PEAK HOLD icon in the METER display function. See “Metering” on page 41 and “Peak Hold” on page 42 of the User’s Guide.*

5. STEREO-BUS-AUX Indicators

These indicators show the meter source points for the channels being monitored.

- **PRE FADER** – When this LED is illuminated, the bus signal before the fader is being displayed.
- **POST FADER** – When this LED is illuminated, the bus signal after the fader is being displayed.

The meter source points are set with the METER display function. See “Meter Source Points” on page 42 of the *User’s Guide*.

6. MIC-LINE-TAPE Indicators

These indicators show the meter source points for the channels being monitored.

- **PRE EQ** – When this LED is illuminated, the signal before the equalizer signal is being displayed.
- **POST EQ** – When this LED is illuminated, the signal after the equalizer is being displayed.
- **POST FADER** – When this LED is illuminated, the signal after the fader is being displayed.

The meter source points are set with the METER display function. See “Meter Source Points” on page 42 of the *User’s Guide*.

14 Specifications

In this chapter...

General Specifications	192
Input Specifications	198
Output Specifications	200
Digital Input and Output Specifications	200
Dimensions	201
Options	202
Troubleshooting	203
Error Messages	204
MIDI Data Format	206
Parameter Change and Request Format	209
Bulk Dump and Request Format	213

General Specifications

Number of scene memories	64	
Sampling frequency	Internal	44.1 kHz, 48 kHz
	External	(32 kHz -6%) to (48 kHz +6%)
Signal delay	Less than 2.5 ms. MIC/LINE input to STEREO output.	
Fader resolution	+10 to -90, -∞ dB (128 steps/100 mm) input faders.	
	0 to -120, -∞ dB (128 steps/100 mm) stereo fader.	
Total harmonic distortion (THD)	Less than 0.2%, 20 Hz to 20 kHz (analog output) @+14 dB into 600Ω.	
Frequency response	+1, -3 dB, 20 Hz to 20 kHz @+4 dB into 600Ω .	
Dynamic range	110 dB typical D/A Converter (STEREO OUT). *	
	105 dB typical A/D to D/A (MIC/LINE IN to STEREO OUT). *	
Hum & Noise (20 Hz to 20 kHz) *, Rs = 150Ω, Input gain max. Input pad = 0 dB Input sensitivity = -60 dBv	-128 dB Equivalent input noise.	
	-88 dB residual output noise. STEREO OUTPUT. STEREO OUTPUT off.	
	-88 dB (92 dB S/N) STEREO OUTPUT. Master fader at nominal level and all channel faders at minimum level.	
	-64 dB (68 dB S/N) STEREO OUTPUT. Master fader at nominal level and all channel faders at nominal level.	
Maximum Voltage Gain	74 dB MIC/LINE (1 through 16) IN to STEREO OUT	
	74 dB MIC/LINE (1 through 16) IN to AUX SEND 1, 2, 3, 4, 5, 6 (via PRE INPUT FADER)	
	74 dB MIC/LINE (1 through 16) IN to MONITOR OUT (via STEREO bus)	
	54 dB LINE (17 through 24) IN to STEREO OUT	
Crosstalk(@1kHz)	70 dB adjacent input channels.	
	70 dB input to output.	

* Hum & Noise are measured with a 6 dB/octave filter @12.7 kHz; equivalent to a 20 kHz filter with an infinite dB/octave attenuation.

* Sampling Frequency: Internal 48 kHz

Inputs

Input channel (MIC/LINE 1 through 24)					
Phantom switch	MIC/LINE 1 to 8				
Select switch	A (XLR) / B (phone)	MIC/LINE 1 through 8			
Gain trim	44 dB (−60 to −16)	MIC/LINE 1 through 16			
	44 dB (−40 to +4)	LINE 17/18 through 23/24			
Peak indicator	LED (red) illuminates when post HA level reaches 3 dB below clipping.				
Signal indicator	LED (green) illuminates when post HA level reaches 10 dB below nominal.				
Insert	MIC/LINE 1 through 8 (pre A/D)				
Pad switch	0/20 dB attenuation	MIC/LINE 1 through 16			
AD converter	20 bit linear / 64 times oversampling				
I/O option	ADAT / TASCAM / YAMAHA	MIC/LINE 1 through 16			
Attenuator	0 to 96 dB (1 dB step)				
Filter	DC cut filter / de-emphasis				
4 band parametric equalizer	ON/OFF				
		LOW/HPF	L-MID	H-MID	HIGH/LPF
		10 to 0.1 (Peaking) (41 steps)			
	Q	Low shelving			High shelving
		HPF (slope = 12 dB/oct)			LPF (slope = 12 dB/oct)
	F	21 Hz to 20.1 kHz (@ 48 kHz and 44.1 kHz) 21 Hz to 15.1 kHz (@ 32 kHz) (1/12 octave steps)			
	G	±18 dB (0.5 dB steps)			
		HPF = ON/OFF			LPF = ON/OFF

Input channel (MIC/LINE 1 through 24)		
Dynamics	Compressor / Expander	
	Threshold	-54 dB to 0 dB (1 dB steps)
	Ratio	1, 1.1, 1.3, 1.5, 1.7, 2, 2.5, 3, 3.5, 4, 5, 6, 8, 10, 20, ∞ (16 points)
	Out gain	0 dB to +18 dB (0.5 dB steps)
	Knee	hard, 1, 2, 3, 4, 5 (6 steps)
	Attack	0 ms to 120 ms (1 ms steps)
	Release	5 ms to 42.3 sec (@48 kHz), 6 ms to 46.0 sec (@44.1 kHz), 8 ms to 63.4 sec (@32 kHz) (160 points)
	Gate / Ducking	
	Threshold	-54 dB to 0 dB (1 dB steps)
	Range	-70 dB to 0 dB (1 dB steps)
	Attack	0 ms to 120 ms (1 ms steps)
	Hold	0.02 ms to 1.96 sec (@ 48 kHz), 0.02 ms to 2.13 sec (@ 44.1 kHz), 0.03 ms to 2.94 sec (@ 32 kHz) (216 points)
	Decay	5 ms to 42.3 sec (@ 48 kHz), 6 ms to 46.0 sec (@ 44.1 kHz), 8 ms to 63.4 sec (@32 kHz) (160 points)
	CompannderH / CompannderS	
	Threshold	-54 dB to 0 dB (1 dB steps)
	Ratio	1, 1.1, 1.3, 1.5, 1.7, 2, 2.5, 3, 3.5, 4, 5, 6, 8, 10, 20 (15 points)
	Out gain	-18 dB to 0 dB (0.5 dB steps)
	Width	1 dB to 90 dB (1 dB steps)
	Attack	0 ms to 120 ms (1 ms steps)
	Release	5 ms to 42.3 sec (@48 kHz), 6 ms to 46.0 sec (@44.1 kHz), 8 ms to 63.4 sec (@32 kHz) (160 points)
	Delay	0 to 2600 samples
Phase	NORMAL / REVERSE	
Channel ON/OFF (1 to 20)		
Channel SEL (1 to 20)		
Fader (1 to 20)	100 mm motorized	
	INPUT FADER / AUX1 / AUX2 / AUX3 / AUX4 / AUX5 / AUX6 / AUX7 / AUX8	
Aux send	ON/OFF	
	AUX 1	PRE / POST FADER (external effects)
	AUX 2	PRE / POST FADER (external effects)
	AUX 3	PRE / POST FADER (external effects)
	AUX 4	PRE / POST FADER (external effects)
	AUX 5	PRE / POST FADER (external effects)
	AUX 6	PRE / POST FADER (external effects)
	AUX 7	PRE / POST FADER (internal effects)
	AUX 8	PRE / POST FADER (internal effects)

Input channel (MIC/LINE 1 through 24)	
Pan	33 positions (L = 16 to 1, C, R = 16 to 1)
Routing	BUS 1 through 8. ST. DIRECT
Solo	ON/OFF
	Pre fader / After pan
Meter	Peakhold: ON/OFF
	12 points displays of the pre-EQ / post-EQ / post-fader levels of all channel input are displayed on the screen.

Tape Input channel (TAPE 1 through 16)	
I/O option	ANALOG, ADAT, TASCAM, AES/EBU, YAMAHA
Filter	DC cut filter / de-emphasis
Attenuator	0 to 96 dB (1 dB step)
4 band parametric equalizer	(Parameters are as same as MIC/LINE input equalizer.)
Dynamics	(Parameters are as same as MIC/LINE input dynamics.)
Delay	0 to 2600 sample
Phase	NORMAL / REVERSE
ON/OFF	
Fader	Rotary encoder
	INPUT / AUX1 / AUX2 / AUX3 / AUX4 / AUX5 / AUX6 / AUX7 / AUX8
Aux send	(Parameters are as same as MIC/LINE input aux send.)
Pan	33 positions (L = 16 to 1, C, R = 16 to 1)
Routing	BUS 1 through 8. ST
Solo	ON/OFF
	Pre fader / After pan
Meter	Peakhold: ON/OFF
	12 points displays of the pre-EQ / post-EQ / post-fader levels of all channel input are displayed on the screen.

Effect Return (EFF 1 through 2)	
Attenuator	0 to 96 dB (1 dB step)
4 band parametric equalizer	(Parameters are as same as MIC/LINE input equalizer.)
Delay	0 to 2600 sample
Phase	NORMAL / REVERSE
ON/OFF	
Fader	Rotary encoder
	INPUT / AUX1 / AUX2 / AUX3 / AUX4 / AUX5 / AUX6 / AUX7 / AUX8
Aux send	(Parameters are as same as MIC/LINE input aux send. EFF1 can only send to AUX8. EFF2 can only send to AUX7.)
Pan	33 positions (L = 16 to 1, C, R = 16 to 1)

Effect Return (EFF 1 through 2)	
Routing	BUS 1 through 8. ST
Solo	ON/OFF
	Pre fader / After pan
Meter	Peakhold: ON/OFF
	12 points displays of the pre-EQ / post-EQ / post-fader levels of all channel input are displayed on the screen.

Outputs

STEREO OUT

Dynamics	(parameters are as same as MIC/LINE input dynamics.)
4 band parametric equalizer	(parameters are as same as MIC/LINE input equalizer.)
Fader	100 mm motorized
ON/OFF	
Meter	21-elements x 2 LED meter. (pre fader / post fader)
D/A converter	20bit linear / 8 times oversampling

BUS OUT (BUS1 through BUS8)

Dynamics	(parameters are as same as MIC/LINE input dynamics.)
Level	rotary encoder
Meter	12 points displays of the pre/post fader levels of all channel input are displayed on the screen.
I/O option	ANALOG, ADAT, TASCAM, AES/EBU, YAMAHA

AUX OUT (AUX1 through AUX8)

Level	rotary encoder
Meter	12 points displays of the pre/post fader levels of all channel input are displayed on the screen.
D/A converter	18bit linear / 8 times oversampling (AUX1 through AUX6)

CONTROL ROOM MONITOR OUT

Select switch	2TR-A1 / 2TR-A2 / 2TR-D1 / 2TR-D2 / 2TR-D3 / AUX5 /AUX6 / ST
Mono	ON/OFF
DIM	ON/OFF
D/A converter	20bit linear / 8 times oversampling
Emphasis	Auto ON/OFF
Level control	
Phone level	

STUDIO MONITOR OUT

Select switch	AUX5 / AUX6 / C-R / ST_
D/A converter	18bit linear / 8 times oversampling
Level control	

TALKBACK

Talkback	ON/OFF
Slate	ON/OFF
Level control	
A/D converter	16 bit linear / 64 times oversampling

Libraries

Internal Digital Effector (EFFECT 1, 2)

	Number of factory presets	40
	Number of user library	88

Dynamics

	Number of factory presets	40
	Number of user library	88

Equalizer Library

	Number of factory presets	32
	Number of user library	96

Channel Library

	Number of user library	64
--	------------------------	----

Power Requirement	USA/Canada	120V	60 Hz	
	UK	240V	50 Hz	
	General	230V	50 Hz	
Power Consumption	180W			
Dimensions (H × D × W)	221.5 mm × 685 mm × 672 mm			
Net Weight	31kg			
Free-air operating temperature range	10 to 35°C			
Options	DIGITAL I/O CARD (adat)	CD8-AT	DIGITAL CASCADE KIT	CD8-CS
	AD/DA CARD	CD8-AD	PEAK METER BRIDGE	MB02
	DIGITAL I/O CARD (TDIF-1)	CD8-TDII	MEMORY EXPANSION KIT	ME4M
	DIGITAL I/O CARD (YAMAHA)	CD8-Y	WOODEN SIDE PANEL	W02SP
	DIGITAL I/O CARD (AES/EBU)	CD8-AE, CD8-AE-S		

Input Specifications

Input connection	PAD	GAIN	Actual load impedance	For use with nominal	Input level			Mixer connector
					Sensitivity ^{*1}	Nominal	Max. before clip	
CH INPUT MIC/LINE 1 through 16	0	-60	3kΩ (XLR) 4kΩ (Phone jack)	50 to 600Ω mics and 600Ω lines	-70 dB (245μV)	-60 dB (775μV)	-40 dB (7.75mV)	XLR-3-31 type ^{*2} or Phone Jack (TRS) ^{*3}
		-16			-26 dB (38.8mV)	-16 dB (123mV)	+ 4 dB (1.23V)	
	20				- 6 dB (388mV)	+ 4 dB (1.23V)	+24 dB (12.3V)	

Input connection	PAD	GAIN	Actual load impedance	For use with nominal	Input level			Mixer connector
					Sensitivity* ¹	Nominal	Max. before clip	
CH INPUT LINE 17 through 24		-40	4kΩ	600Ω lines	-50 dB (2.45mV)	-40 dB (7.75mV)	-20 dB (77.5mV)	Phone Jack (TRS) ^{*3}
		+4			-6 dB (388mV)	+4 dB (1.23V)	+24 dB (12.3V)	
INSERT IN MIC/LINE 1 through 8			10kΩ	600Ω lines	-10 dB (245mV)	+0 dB (775mV)	+20 dB (7.75V)	Phone Jack ^{*4}
2 TRACK INPUT [L,R]			10kΩ	600Ω lines	+4 dB (1.23V)	+4 dB (1.23V)	+24 dB (12.3V)	Phone Jack ^{*5}
			10kΩ	600Ω lines	-10 dBV (316mV)	-10 dBV (316mV)	+10 dBV (3.16V)	RCA/phono ^{*6}

*1 Sensitivity is the lowest level that will produce an output of +4 dB (1.23V) or the nominal output level when the unit is set to maximum gain. (All faders and level controls are maximum position.)

*2 XLR type connectors are balanced. (1=GND, 2=HOT, 3=COLD)

*3 MIC/LINE INPUT and LINE INPUT phone jacks are balanced. (Tip=HOT, Ring=COLD, Sleeve=GND)

*4 INSERT INPUT phone jacks are unbalanced. (Tip=OUT, Ring=IN, Sleeve=GND)

*5 2 TRACK INPUT phone jacks are balanced.

*6 2 TRACK INPUT RCA/phone jacks are unbalanced.

* In these specifications, when dB represents are specific voltage, 0 dB is referenced to 0.775 volts RMS.

* In these specifications, when dBV represents are specific voltage, 0 dBV is referenced to 1 volts RMS.

Output Specifications

Output connection	Actual source impedance	For use with nominal	Output level		Mixer connector
			Nominal	Max before clip	
STEREO OUT (L, R)	150Ω	600Ω lines	+ 4 dB (1.23V)	+24 dB (12.3V)	XLR-3-32 type
	600Ω	10kΩ lines	-10 dBV (316mV)	+10 dBV (3.16V)	RCA/phono (Unbalanced)
STUDIO MONITOR OUT (L, R)	150Ω	10kΩ lines	+ 4 dB (1.23V)	+24 dB (12.3V)	Phone Jack (Balanced)
CONTROL ROOM MONITOR OUT (L, R)	150Ω	10kΩ lines	+ 4 dB (1.23V)	+24 dB (12.3V)	Phone Jack (Balanced)
AUX (1, 2, 3, 4, 5, 6)	600Ω	10kΩ lines	+ 4 dB (1.23V)	+20 dB (7.75V)	Phone Jack (Unbalanced)
INSERT OUT MIC/LINE 1 through 8	600Ω	10kΩ lines	+ 0 dB (0.775V)	+20 dB (7.75V)	Phone Jack (Unbalanced)*1
PHONES	100Ω	8Ω phones	1 mW	25 mW	Stereo Phone Jack (Unbalanced)
		40Ω phones	3 mW	110 mW	

*1 INSERT OUTPUT phone jacks are balanced. (Tip=OUT, Ring=IN, Sleeve=GND)

* In these specifications, when dB represents are specific voltage, 0 dB is referenced to 0.775 volts RMS.

* In these specifications, when dBV represents are specific voltage, 0 dBV is referenced to 1 volts RMS.

Digital Input and Output Specifications

Input/Output	Format	Level	Mixer connector
DIGITAL IN (COAXIAL) (2TRK IN 2, 3)	IEC958 Consumer (S/PDIF)	0.5Vpp/75Ω	RCA/phono jack
DIGITAL OUT (COAXIAL) (STEREO OUT)	IEC958 Consumer (S/PDIF)	0.5Vpp/75Ω	RCA/phono jack
DIGITAL IN (AES/EBU) (2TRK IN 1)	IEC958 Professional (AES/EBU)	RS422	XLR-3-32 type
DIGITAL OUT (AES/EBU) (STEREO OUT)	IEC958 Professional (AES/EBU)	RS422	XLR-3-31 type
WORD CLOCK IN	–	TTL / 75Ω	BNC
WORD CLOCK OUT	–	TTL / 75Ω	BNC
MIDI IN	MIDI	–	DIN Connector 5P
MIDI OUT	MIDI	–	DIN Connector 5P
MIDI THRU	MIDI	–	DIN Connector 5P
TO HOST	–	–	MiniDIN Connector 8P
METER	–	RS422	Dsub Connector 15p
MTC IN	MIDI	–	DIN Connector 5P
TC IN	SMPTE	Nominal -10 dBV/10kΩ	RCA/phono jack

Dimensions

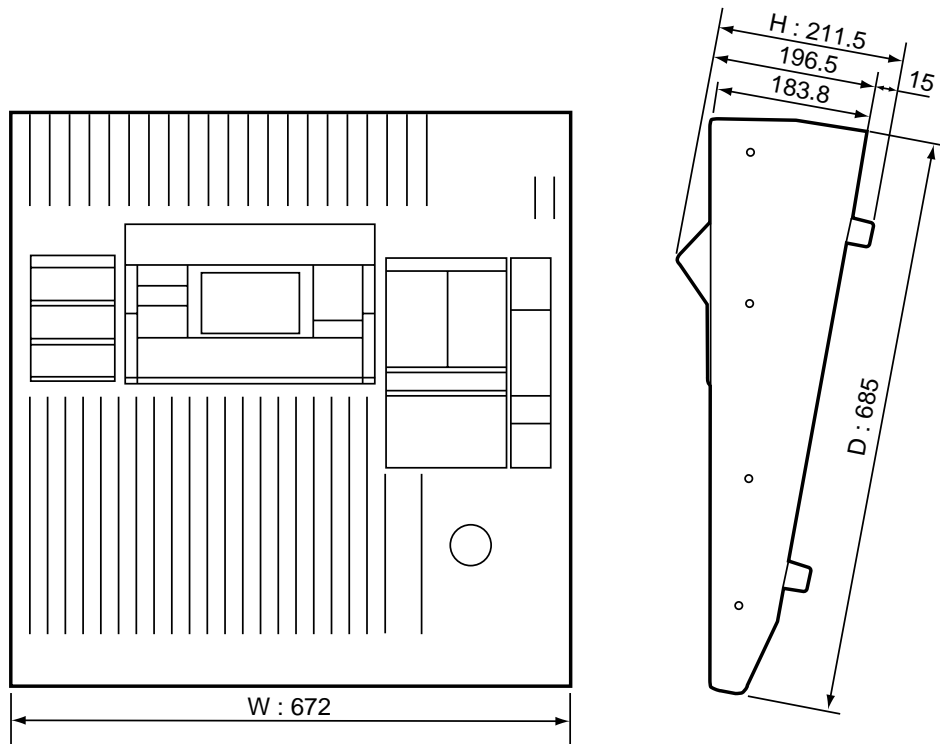

Specifications and external appearance are subject to change without notice.

Options

AD/DA I/O Card Specifications

Analog Input

Input connections	GAIN	Actual load impedance	For use with nominal	Input level			Mixer connector
				Sensitivity* ¹	Nominal	Max. before clip	
INPUT 1 through 8	+4	10k Ω	600 Ω lines	-6 dB (388mV)	+4 dB (1.23mV)	+24 dB (12.3mV)	Phone Jack (TRS) ^{*2}
	-10			-20 dBV (100mV)	-10 dBV (316mV)	+10 dBV (3.16V)	

*1 Sensitivity is the lowest level that will produce an output of +4 dB (1.23V) or the nominal output level when the unit is set to maximum gain. (All faders and level controls are maximum position.)

*2 CH INPUT phone jacks are balanced. (Tip=HOT, Ring=COLD, Sleeve=GND)

* In these specifications, when dB represents are specific voltage, 0 dB is referenced to 0.775 volts RMS.

* In these specifications, when dBV represents are specific voltage, 0 dBV is referenced to 1 volts RMS.

Analog Output

Output connections	GAIN	Actual source impedance	For use with nominal	Output level		Mixer connector
				Nominal	Max before clip	
OUTPUT 1 through 8	+4	150 Ω	10k Ω lines	+4 dB (1.23mV)	+24 dB (12.3mV)	Phone Jack (TRS) ^{*1}
	-10			-10 dBV (316mV)	+10 dBV (3.16V)	

*1 CH OUTPUT phone jacks are balanced. (Tip=HOT, Ring=COLD, Sleeve=GND)

* In these specifications, when dB represents are specific voltage, 0 dB is referenced to 0.775 volts RMS.

* In these specifications, when dBV represents are specific voltage, 0 dBV is referenced to 1 volts RMS.

Digital I/O Card Specifications

Digital Input/Output

Input/Output	Format	Level	Mixer connector
DA88/DA38 (BUS/DIRECT OUT, TAPE IN)	TDIF-1	C-MOS	D-SUB 25PIN
ADAT (BUS/DIRECT OUT, TAPE IN)	ADAT	OPTICAL	
AES/EBU (BUS/DIRECT OUT, TAPE IN)	AES/EBU	RS422	XLR-3-31 type (INPUT)
			XLR-3-32 type (OUTPUT)
			D-SUB 25PIN
YAMAHA (BUS/DIRECT OUT, TAPE IN)	YAMAHA	RS422	D-SUB 25PIN
CASCADE (BUS/DIRECT OUT, TAPE IN)	YAMAHA	RS422	D-SUB 25PIN

Troubleshooting

If there is any trouble, check the situation and follow the corrective actions described below.

The power is not turned on.

- Did you plug the power cord to a correct AC outlet?
- Is the POWER switch ON?

No sound is produced.

- Is the signal coming in from the external device?
- Is the input "ON" indicator lit?
- Is the input fader raised?
- Is the stereo output "ON" indicator lit?
- Is the stereo output fader raised?
- Is the option board securely inserted?
- Is the output bus assigned correctly?
- Is the word clock set correctly?
- Is the output in the C-R monitor section selected?

The volume level is very low.

- Are the PAD switch and GAIN volume control set correctly?
- Is the input fader raised?
- Is the gain set too low in the equalizer section?
- Are the threshold and ratio settings for the dynamics processor set correctly?
- Is the [DIM] key in the C-R monitor section OFF?

Sound is distorted.

- Are the PAD switch and GAIN volume control set correctly?
- Is the input fader raised too high?
- Is the stereo output fader raised too high?
- Is the gain set too high in the equalizer section?

A pair of stereo channels does not sound in stereo.

- Is the pan setting correct?

Abnormal phase

- Is the phase on the input device set correctly?

The volume level of certain channels goes up and down.

- Is the dynamics processor ducking set for those channels?

Scene data cannot be stored.

- Is memory protect ON?
- You cannot store scene data to Scene "0."

MIDI data cannot be transmitted or received.

- Does the MIDI transmit channel match the receive channel?
- Is the switch for the item to be transmitted/received (Program Change, Parameter Change) turned on?

The fader movement is not consistent.

- Calibrate the faders. See "Fader Calibration" on page 170 of the *User's Guide*.

Error Messages

Follow the corrective actions described below when the error messages are shown on the display:

Error Message	Corrective Action
2TR-D1 No Input!	Correct digital signal is not input to 2TR-D1. (C-R monitoring is not available.)
2TR-D2 Cascade Disabled	2TR-D2 cannot be routed to STEREO BUS. (Incorrect word clock setting)
2TR-D2 No Input!	Correct digital signal is not input to 2TR-D2. (C-R monitoring is not available.)
2TR-D3 No Input!	Correct digital signal is not input to 2TR-D3. (C-R monitoring is not available.)
Automix Aborted!	Automix data was aborted. (You can undo the operation.)
Automix Disabled!	Time code was input, but automix is disabled.
Automix REC Ready!	Ready for recording automix.
Automix Recording!	Recording automix now.
Automix Running!	Automix is now running.
Automix Updated!	Automix has been updated. (You can undo the operation.)
Byte Count Error!	Byte count for the received bulk data is not correct.
Can't assign 2TR-D1!	2TR-D1 cannot be routed to line 17/18. (The signal at 2TR-D1 is not syncing with the 02R, or 2TR-D1 has been selected in the C-R monitor section.)
Can't assign 2TR-D2!	2TR-D2 cannot be routed to line 19/20. (The signal at 2TR-D2 is not syncing with the 02R, or 2TR-D2 has been selected in the C-R monitor section.)
Can't select SLOT3!	SLOT3 cannot be selected for digital input. (The I/O card is not in SLOT3.)
Can't select SLOT4!	SLOT4 cannot be selected for digital input. (The I/O card is not in SLOT4.)
Can't select WORD CLOCK!	Not available as a word clock source.
Cannot Copy Title!	You cannot copy the title from the memory that has no data.
Cannot Paste Title!	You cannot paste the title to the memory that has no data.
Check Sum Error!	Check sum of the received bulk data is not correct.
Code Mismatch!	Product code for the received bulk data is not correct.
DIGITAL I/O Error!	Incoming signal from SLOT DIO is not syncing with the 02R. The synchronization system has not been configured successfully. Or, if the sync system has been configured, this message may still appear if the clock sent from the MTR is unstable until the digital MTR enters CHASE status. You can select whether this message will be shown or not. (see "Preferences" on page 162 of the <i>User's Guide</i>)
Duplicate Grouping!	You cannot duplicate the group.

Error Message	Corrective Action
Fixed Fragmentation!	The automix memory has been corrected. Abnormal data may be generated in the memory if you turn off the power during recording or if incomplete bulk data is received.
Frame Drop Out!(#)	Time code frame is dropping out. (The count in the parenthesis shows the number of dropping frames.)
Frame Jump!	Time code frame is dropping out.
ID Mismatch!	Model ID for parameter change is not correct.
Illegal Time Range!	In/out time setting is incorrect.
Low Battery!	The internal battery voltage is getting very low. Back-up the setup data stored in the 02R (see "Bulk Dump/Request" on page 145 of the <i>User's Guide</i>), and ask your dealer to replace the battery.
MAIN SCI0 Framing Err.	Consult the nearest YAMAHA service center.
MAIN SCI0 OverRun Err.	Consult the nearest YAMAHA service center.
MAIN SCI0 Party Err.	Consult the nearest YAMAHA service center.
MAIN SCI0 RxBuf. Full	MIDI data being transmitted is too large.
MAIN SCI0 TxBuf. Full	MIDI data being received is too large.
MAIN SCI1 Framing Err.	Check the connection at the TO HOST connector.
MAIN SCI1 OverRun Err.	Check the connection at the TO HOST connector.
MAIN SCI1 Party Err.	Check the connection at the TO HOST connector.
MAIN SCI1 RxBuf. Full	Check the connection at the TO HOST connector.
MAIN SCI1 TxBuf. Full	Check the connection at the TO HOST connector.
MAIN->SUB Disconnected!	Consult the nearest YAMAHA service center.
Make New Mix!	First make a New Mix.
Memory Full!	Automix memory is full.
MIDI Ch Mismatch (#)	The device number of the received bulk data is not correct.
No Aux Send!	There is no AUX send from EFF1 to AUX7 or EFF2 to AUX8.
No Time Code!	Time code is not being input.
Preset is read only!	You cannot store data to the preset memory.
Redone.	The previous operation was redone.
Scene 0 is read only!	You cannot store data to Scene "0."
Scene Memory Protected!	Scene memory is write-protected.
Select Channel!	A channel for extract has not been assigned.
Select Parameter!	The parameter for extract has not been assigned.
Set Overwrite!	Set the overwrite parameter.
SOLO Ready!	The track is ready for solo.
SOLO Slave!	You cannot change the solo status and the Solo key is disabled if the unit is a cascade slave.
SUB->MAIN Disconnected!	Consult the nearest YAMAHA service center.
SUB SCI0 Framing Err.	Consult the nearest YAMAHA service center.
SUB SCI0 OverRun Err.	Consult the nearest YAMAHA service center.
SUB SCI0 Party Err.	Consult the nearest YAMAHA service center.

Error Message	Corrective Action
SUB SCI0 RxBuf. Full	MIDI data being transmitted is too large.
SUB SCI0 TxBuf. Full	MIDI data being received is too large.
SUB SCI1 Framing Err.	Check the MIDI connection.
SUB SCI1 OverRun Err.	Check the MIDI connection.
SUB SCI1 Party Err.	Check the MIDI connection.
SUB SCI1 RxBuf. Full	MIDI data being transmitted is too large.
SUB SCI1 TxBuf. Full	MIDI data being received is too large.
TC RxBuf. Full	Buffer for time code reception is full.
TC TxBuf. Full	Buffer for time code transmission is full.
Too Large Bulk!	MIDI bulk data size is too large.
Undo Buf. is Empty!	The previous operation cannot be undone because no undo buffer.
Undo Buf. is Full!	The store operation cannot be done because the data undo buffer.
Undone Recall.	The recall operation was undone.
Undone Store.	The store operation was undone.
Wrong WORD CLOCK!	The device for synchronization (selected from the 02R) is not the correct word clock. Re-configure the synchronization settings.
Too many cascade in/out cards. Shut off the power and check slot, please.	There are more than two cascade cards or too many cards in the "out" setting. Check the slot condition, and turn the power off to the 02R again.

MIDI Data Format

1. General remarks

- 1-1 This section describes the MIDI functionality of the 02R.
- 1-2 Electrical characteristics and message formats are in compliance with MIDI standard 1.0.

2. Messages transmitted and received

2-1. Program change

Transmission/reception can be turned ON or OFF using the “MIDI Setup” display function (see “Setup” on page 143 of the *User’s Guide*).

When a memory recall occurs, the program change corresponding to that memory number will be transmitted on the specified MIDI channel.

When a program change is received on the specified MIDI channel or in OMNI mode, the memory corresponding to that program number will be recalled.

The user can create a customized program change assign table (see “Program Change Assign” on page 144 of the *User’s Guide*).

2-2. System exclusive messages

System exclusive messages include Bulk Dump/Request and Parameter Change/Request. For these messages, the device number will be the same as the MIDI channel.

BULK DUMP/REQUEST

Transmission and reception is always ON.

Bulk Request is transmitted using the “MIDI Bulk Dump & Request” display function (see “Bulk Dump/Request” on page 145 of the *User’s Guide*) on the specified MIDI channel.

Bulk Dump transmits the contents of the corresponding memory on the specified MIDI channel, and is transmitted either by operations in the “MIDI Bulk Dump & Request” display function, or when a Bulk Request is received on the specified MIDI channel.

When a Bulk Dump is received, the contents of the corresponding memory will change.

PARAMETER CHANGE/REQUEST

Transmission/reception can be turned ON or OFF using the “MIDI Setup” display function (see “Setup” on page 143 of the *User’s Guide*).

If parameter change transmission is ON, a message will be transmitted on the specified MIDI channel when the parameters of the 02R are modified.

If parameter change reception is ON and a parameter request is received on the specified MIDI channel, the contents of the corresponding parameter will be transmitted on the specified MIDI channel regardless of whether transmission is ON or OFF.

If parameter change reception is ON and a parameter change is received on the specified MIDI channel, the contents of the corresponding parameter will be modified.

Transmission of KEY REMOTE parameter changes can be turned ON or OFF using the "Preferences" display function (see "Preferences" on page 162 of the *User's Guide*) independently of other parameters. This is used only in special circumstances such as when externally monitoring key operations. Normally, it should be left OFF.

2-3. Active sensing, MIDI reset

If, after receiving Active Sensing, no messages are received for an interval longer than 300 ms, or when MIDI Reset is received, only the running status will be cleared.

Active Sensing is transmitted.

2-4. Quarter-frame messages

MIDI Time Code Quarter-frame messages are received at the MTC connector.

3. ECHO BACK

If ECHO is turned ON, the Program Change messages will be transmitted immediately after being received.

4. Transmission Condition

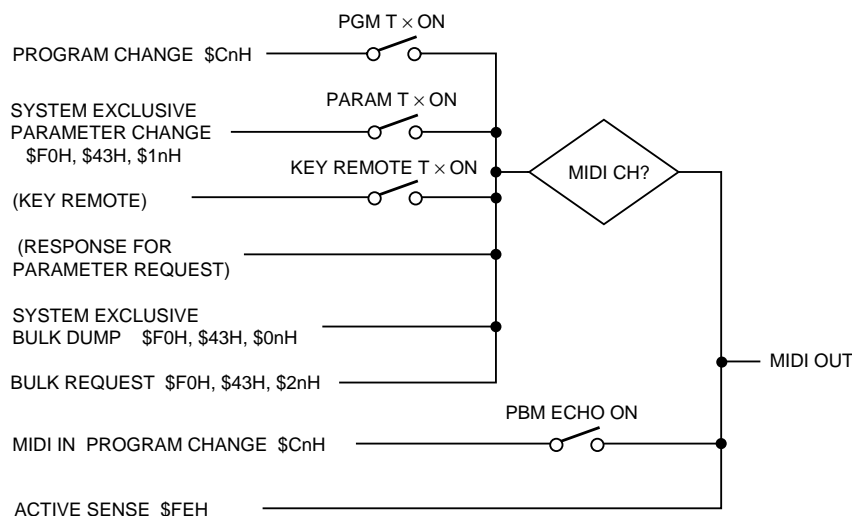

5. Receive Condition

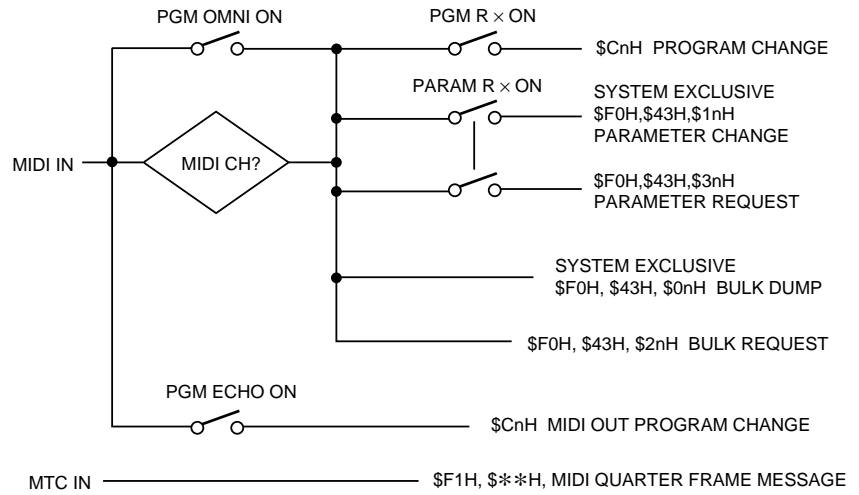

Parameter Change and Request Format

PARAMETER CHANGE (basic format)		
STATUS	11110000 F0	System Exclusive Message
ID No.	01000011 43	Manufacturer's ID No.(YAMAHA)
SUB STATUS	0001nnnn 1n	n=0-15(Tx/Rx Channel No.1-16)
MODEL ID	00111101 3d	MODEL ID (02R)
PARAM TYPE	0tttttttt tt	(type number, bit6:0=byte 1=bit operation)
DATA	0ddddddd dd0	data 0-n
	:	:
	0ddddddd ddn	
EOX	11110111 F7	End Of Exclusive

PARAMETER CHANGE REQUEST		
STATUS	11110000 F0	System Exclusive Message
ID No.	01000011 43	Manufacturer's ID No.(YAMAHA)
SUB STATUS	0011nnnn 3n	n=0-15(Tx/Rx Channel No.1-16)
MODEL ID	00111101 3d	MODEL ID (02R)
PARAM TYPE	0tttttttt tt	(type number, bit6:0=byte)
DATA	0ddddddd dd0	address(H) high 7 bits of 14 bits address
	0ddddddd dd1	address(L) low 7 bits of 14 bits address
	0ddddddd dd2	count
EOX	11110111 F7	End Of Exclusive

type number:

- 0 edit buffer(used byte or bit operation format)
- 1 setup(used byte operation format, request and response for request only)
- 2 backup(used byte operation format, request and response for request only)
- 24 recall/store(parameter change only)
- 25 key remote(parameter change only)
- 26 fader/encoder Remote(parameter change only)

PARAMETER CHANGE (byte operation for type number 0:edit buffer, 1:setup, 2:backup)		
STATUS	11110000 F0	System Exclusive Message
ID No.	01000011 43	Manufacturer's ID No.(YAMAHA)
SUB STATUS	0001nnnn 1n	n=0-15(Tx/Rx Channel No.1-16)
MODEL ID	00111101 3d	MODEL ID (02R)
PARAM TYPE	00tttttttt tt	(type number, bit6 = 0(byte operation))

PARAMETER CHANGE (byte operation for type number 0:edit buffer, 1:setup, 2:backup)		
DATA	0ddddddd dd0	address(H) high 7 bits of 14 bits address
	0ddddddd dd1	address(L) low 7 bits of 14 bits address
	0ddddddd dd2	data(H) high 4 bits of 8 bits data(0000dddd)
	0ddddddd dd3	data(L) low 4 bits of 8 bits data(0000dddd)
	:	:
EOX	11110111 F7	End Of Exclusive

You can modify two or more continuous bytes by increasing pairs of "data(H)" and "data(L)".

PARAMETER CHANGE (bit operation for type number 0:edit buffer)		
STATUS	11110000 F0	System Exclusive Message
ID No.	01000011 43	Manufacturer's ID No.(YAMAHA)
SUB STATUS	0001nnnn 1n	n=0-15(Tx/Rx Channel No.1-16)
MODEL ID	00111101 3d	MODEL ID (02R)
PARAM TYPE	01tttttt tt	(type number, bit6 = 1(bit operation))
DATA	0ddddddd dd0	address(H) high 7 bits of 14 bits address
	0ddddddd dd1	address(L) low 7 bits of 14 bits address
	0ddddddd dd2	data(bit0-3:change bit0-7 bit4:0=reset 1=set)
	:	:
EOX	11110111 F7	End Of Exclusive

You can modify two or more bits in same address data.

PARAMETER CHANGE (recall/store)		
STATUS	11110000 F0	System Exclusive Message
ID No.	01000011 43	Manufacturer's ID No.(YAMAHA)
SUB STATUS	0001nnnn 1n	n=0-15(Tx/Rx Channel No.1-16)
MODEL ID	00111101 3d	MODEL ID (02R)
PARAM TYPE	00011000 18	recall/store (type number)
DATA	0ddddddd dd0	instruction
	0ddddddd dd1	number
	0ddddddd dd2	channel
EOX	11110111 F7	End Of Exclusive

instruction	number	channel		
0x00 scene recall	0-64 (memory 0-64)	0	Tx only	
	0x7e (undo)	0	Tx only	
0x01 eq lib recall	0-127 (library 1-128)	0-15(mic1-16)		
		16-31(tape1-16)		
		32-35(line)		
		36,37(eff1,eff2)		
		38(st mas)		
		0	64-79(undo mic)	Tx only
			80-95(undo tape)	Tx only
	96-99(undo line)	Tx only		
	100,101(undo eff)	Tx only		
	102(undo st mas)	Tx only		
0x02 dynamics lib rcl	0-127 (library 1-128)	0-35,38,39-46(bus,aux)		
	0	64-95,102	Tx only	
		103-110(undo bus,aux)	Tx only	
0x03 eff lib recall	0-127 (library 1-128)	36,37		
	0	100,101	Tx only	
0x04 channel lib rcl	0-63 (library 1-64)	0-37		
	0	64-101	Tx only	
0x10 scene store	1-64 (memory 1-64)	0, 62(from host)	Tx only	
	0x7e (undo)	0	Tx only	
0x11 eq lib store	32-127 (library 33-128)	0-38,62	Tx only	
	0	64-102	Tx only	
0x12 dynamics lib str	40-127 (library 41-128)	0-35,38,39-46,62	Tx only	
	0	64-95,102,103-110	Tx only	
0x13 eff lib store	40-127 (library 41-128)	36,37,62	Tx only	
	0	100,101	Tx only	
0x14 channel lib str	0-63 (library 1-64)	0-37,62	Tx only	
	0	64-101	Tx only	

PARAMETER CHANGE (key remote)

STATUS	11110000 F0	System Exclusive Message
ID No.	01000011 43	Manufacturer's ID No.(YAMAHA)
SUB STATUS	0001nnnn 1n	n=0-15(Tx/Rx Channel No.1-16)
MODEL ID	00111101 3d	MODEL ID (02R)
PARAM TYPE	00011001 19	key remote (type number)
DATA	0ddddddd dd0	key No.(H) high 7 bits
	0ddddddd dd1	key No.(L) low 7 bits
	0ddddddd dd2	key on(1)/off(0)
EOX	11110111 F7	End Of Exclusive

PARAMETER CHANGE (fader remote)		
STATUS	11110000 F0	System Exclusive Message
ID No.	01000011 43	Manufacturer's ID No.(YAMAHA)
SUB STATUS	0001nnnn 1n	n=0-15(Tx/Rx Channel No.1-16)
MODEL ID	00111101 3d	MODEL ID (02R)
PARAM TYPE	00011001 1A	fader remote (type number)
DATA	0ddddddd dd0	No. (0-20:fader 1-21(st mas) 64-87:encoder tape1-16,rtn1-2,aux,pan,q,f,g,entry)
	0ddddddd dd1	data(fader 0~127/ encoder -64~+63)
EOX	11110111 F7	End Of Exclusive

Bulk Dump and Request Format

The data format is as following. For example, Internal data: ds,d1,d2,...dx,...de(dx is 1byte data).

$$dxH = (dx / 16) \text{ AND } 0Fh, dxL = dx \text{ AND } 0Fh$$

To calculate the check sum: add the data from BYTE COUNT(LOW) to just before the CHECK SUM, multiplying -1(2's complement), resetting MSB(bit7).

$$\text{check sum} = (-\text{sum}) \& 0x7F$$

Scene Memory Bulk Dump Format		
STATUS	11110000 F0	System Exclusive Message
ID No.	01000011 43	Manufacturer's ID No.(YAMAHA)
SUB STATUS	0000nnnn 0n	n=0-15(Tx/Rx Channel No.1-16)
FORMAT No.	01111110 7E	Universal Bulk Dump
BYTE COUNT (HIGH/LOW)	00011111 1F	4074(2016x2+32+10)bytes
	01101010 6A	
	01001100 4C	'L'
	01001101 4D	'M'
	00100000 20	''
	00100000 20	''
	00111000 38	'8'
	01000001 41	'A'
	00110110 36	'6'
	00110111 37	'7'
DATA NAME	01001101 4D	'M'
	0mmmmmmmm mm	m=0-64,127(Scene Memory No.0-64,current)
DATA	0iiiiiii ii	id 1
	: :	:
	0iiiiiii ii	id 16
	0tttttttt tt	title1
	: :	:
	0tttttttt tt	title16
	0ddddddd dsH	Scene Memory(2016x2bytes)
	0ddddddd dsL	
	: :	
	0ddddddd deH	
0ddddddd deL		
CHECK SUM	0eeeeeee ee	ee=(INVERT('L'+ 'M'+...+dsH+...+deL)+1) AND 7Fh
EOX	11110111 F7	End Of Exclusive

Scene memory receive is effective for programs 1-64 only.

Scene Memory Bulk Dump Request Format

STATUS	11110000 F0	System Exclusive Message
ID No.	01000011 43	Manufacturer's ID (YAMAHA)
SUB STATUS	0010nnnn 2n	n=0-15(Tx/Rx Channel No.1-16)
FORMAT No.	01111110 7E	Universal Bulk Dump
	01001100 4C	'L'
	01001101 4D	'M'
	00100000 20	''
	00100000 20	''
	00111000 38	'8'
	01000001 41	'A'
	00110110 36	'6'
	00110111 37	'7'
DATA NAME	01001101 4D	'M'
	0mmmmmmmm mm	m=0-64,127(Scene Memory No.0-64,current)
EOX	11110111 F7	End Of Exclusive

Scene memory transmission from the 02R is possible for programs 1-64 only.

Program Change Assignment Table Bulk Dump Format

STATUS	11110000 F0	System Exclusive Message
ID No.	01000011 43	Manufacturer's ID No.(YAMAHA)
SUB STATUS	0000nnnn 0n	n=0-15(Tx/Rx Channel No.1-16)
FORMAT No.	01111110 7E	Universal Bulk Dump
BYTE COUNT (HIGH/LOW)	00000010 02	266(128x2+10)bytes
	00001010 0A	
	01001100 4C	'L'
	01001101 4D	'M'
	00100000 20	''
	00100000 20	''
	00111000 38	'8'
	01000001 41	'A'
	00110110 36	'6'
	00110111 37	'7'
DATA NAME	01010000 50	'P'
	00100000 20	''

Program Change Assignment Table Bulk Dump Format		
DATA	0ddddddd dsH	Program Change Table(128x2bytes)
	0ddddddd dsL	
	: :	
	0ddddddd deH	
	0ddddddd deL	
CHECK SUM	0eeeeeee ee	ee=(INVERT('L'+ 'M'+...+dsH+...+deL)+1) AND 7Fh
EOX	11110111 F7	End Of Exclusive

Program Change Assignment Table Bulk Dump Request Format		
STATUS	11110000 F0	System Exclusive Message
ID No.	01000011 43	Manufacturer's ID (YAMAHA)
SUB STATUS	0010nnnn 2n	n=0-15(Tx/Rx Channel No.1-16)
FORMAT No.	01111110 7E	Universal Bulk Dump
	01001100 4C	'L'
	01001101 4D	'M'
	00100000 20	''
	00100000 20	''
	00111000 38	'8'
	01000001 41	'A'
	00110110 36	'6'
	00110111 37	'7'
DATA NAME	01010000 50	'P'
	00100000 20	''
EOX	11110111 F7	End Of Exclusive

Setup Memory Bulk Dump Format		
STATUS	11110000 F0	System Exclusive Message
ID No.	01000011 43	Manufacturer's ID No.(YAMAHA)
SUB STATUS	0000nnnn 0n	n=0-15(Tx/Rx Channel No.1-16)
FORMAT No.	01111110 7E	Universal Bulk Dump
BYTE COUNT (HIGH/LOW)	00000000 00	266(128x2+10)bytes
	01101010 6A	

Setup Memory Bulk Dump Format		
	01001100 4C	'L'
	01001101 4D	'M'
	00100000 20	''
	00100000 20	''
	00111000 38	'8'
	01000001 41	'A'
	00110110 36	'6'
	00110111 37	'7'
DATA NAME	01010011 53	'S'
	00100000 20	''
DATA	0ddddddd dsH	Setup Memory(128x2bytes)
	0ddddddd dsL	
	: :	
	0ddddddd deH	
	0ddddddd deL	
CHECK SUM	0eeeeeee ee	ee=(INVERT('L'+ 'M'+...+dsH+...+deL)+1) AND 7Fh
EOX	11110111 F7	End Of Exclusive

Setup Memory Bulk Dump Request Format		
STATUS	11110000 F0	System Exclusive Message
ID No.	01000011 43	Manufacturer's ID (YAMAHA)
SUB STATUS	0010nnnn 2n	n=0-15(Tx/Rx Channel No.1-16)
FORMAT No.	01111110 7E	Universal Bulk Dump
	01001100 4C	'L'
	01001101 4D	'M'
	00100000 20	''
	00100000 20	''
	00111000 38	'8'
	01000001 41	'A'
	00110110 36	'6'
	00110111 37	'7'
DATA NAME	01010011 53	'S'
	00100000 20	''
EOX	11110111 F7	End Of Exclusive

Effect Library Bulk Dump Format		
STATUS	11110000 F0	System Exclusive Message
ID No.	01000011 43	Manufacturer's ID No.(YAMAHA)
SUB STATUS	0000nnnn 0n	n=0-15(Tx/Rx Channel No.1-16)
FORMAT No.	01111110 7E	Universal Bulk Dump
BYTE COUNT (HIGH/LOW)	00000000 00	72(23x2+16+10)bytes
	01001000 48	
	01001100 4C	'L'
	01001101 4D	'M'
	00100000 20	' '
	00100000 20	' '
	00111000 38	'8'
	01000001 41	'A'
	00110110 36	'6'
	00110111 37	'7'
DATA NAME	01000101 45	'E'
	0mmmmmmm mm	m=0-127(Effect Library No.1-128)
DATA	0tttttttt tt	title1
	: :	
	0tttttttt tt	title16
	0ddddddd dsH	Effect Library Memory(23x2bytes)
	0ddddddd dsL	
	: :	
	0ddddddd deH	
	0ddddddd deL	
0ddddddd deL		
CHECK SUM	0eeeeeee ee	ee=(INVERT('L'+ 'M'+...+dsH+...+deL)+1) AND 7Fh
EOX	11110111 F7	End Of Exclusive

Effect library receive is effective for programs 41-128 only.

Effect Library Bulk Dump Request Format		
STATUS	11110000 F0	System Exclusive Message
ID No.	01000011 43	Manufacturer's ID (YAMAHA)
SUB STATUS	0010nnnn 2n	n=0-15(Tx/Rx Channel No.1-16)
FORMAT No.	01111110 7E	Universal Bulk Dump

Effect Library Bulk Dump Request Format		
	01001100 4C	'L'
	01001101 4D	'M'
	00100000 20	''
	00100000 20	''
	00111000 38	'8'
	01000001 41	'A'
	00110110 36	'6'
	00110111 37	'7'
DATA NAME	01000101 45	'E'
	0mmmmmmm mm	m=0-127(Effect Library No.1-128)
EOX	11110111 F7	End Of Exclusive

Effect library transmission from the 02R is possible for programs 41-128 only.

Equalizer Library Bulk Dump Format		
STATUS	11110000 F0	System Exclusive Message
ID No.	01000011 43	Manufacturer's ID No.(YAMAHA)
SUB STATUS	0000nnnn 0n	n=0-15(Tx/Rx Channel No.1-16)
FORMAT No.	01111110 7E	Universal Bulk Dump
BYTE COUNT (HIGH/LOW)	00000000 00	62(18x2+16+10)bytes
	00111110 3e	
	01001100 4C	'L'
	01001101 4D	'M'
	00100000 20	''
	00100000 20	''
	00111000 38	'8'
	01000001 41	'A'
	00110110 36	'6'
	00110111 37	'7'
DATA NAME	01010001 51	'Q'
	0mmmmmmm mm	m=0-127(Equalizer Library No.1-128)
DATA	0ttttttt tt	title1
	: :	
	0ttttttt tt	title16
	0ddddddd dsH	Equalizer Library Memory(18x2bytes)
	0ddddddd dsL	
	: :	
	0ddddddd deH	
	0ddddddd deL	

Equalizer Library Bulk Dump Format

CHECK SUM	0eeeeeee ee	ee=(INVERT('L'+ 'M'+...+dsH+...+deL)+1) AND 7Fh
EOX	11110111 F7	End Of Exclusive

Equalizer library receive is effective for programs 33-128 only.

Equalizer Library Bulk Dump Request Format

STATUS	11110000 F0	System Exclusive Message
ID No.	01000011 43	Manufacturer's ID (YAMAHA)
SUB STATUS	0010nnnn 2n	n=0-15(Tx/Rx Channel No.1-16)
FORMAT No.	01111110 7E	Universal Bulk Dump
	01001100 4C	'L'
	01001101 4D	'M'
	00100000 20	''
	00100000 20	''
	00111000 38	'8'
	01000001 41	'A'
	00110110 36	'6'
	00110111 37	'7'
DATA NAME	01010001 51	'Q'
	0mmmmmmm mm	m=0-127(Equalizer Library No.1-128)
EOX	11110111 F7	End Of Exclusive

Equalizer library transmission from the 02R is possible for programs 33-128 only.

Dynamics Library Bulk Dump Format

STATUS	11110000 F0	System Exclusive Message
ID No.	01000011 43	Manufacturer's ID No.(YAMAHA)
SUB STATUS	0000nnnn 0n	n=0-15(Tx/Rx Channel No.1-16)
FORMAT No.	01111110 7E	Universal Bulk Dump
BYTE COUNT (HIGH/LOW)	00000000 00	44(9x2+16+10)bytes
	00101100 2c	
	01001100 4C	'L'
	01001101 4D	'M'
	00100000 20	''
	00100000 20	''
	00111000 38	'8'
	01000001 41	'A'
	00110110 36	'6'
	00110111 37	'7'

Dynamics Library Bulk Dump Format		
DATA NAME	01011001 59	'Y'
	0mmmmmmm mm	m=0-127(Dynamics Library No.1-128)
DATA	0tttttttt tt	title1
	: :	
	0tttttttt tt	title16
	0ddddddd dsH	Dynamics Library Memory(9x2bytes)
	0ddddddd dsL	
	: :	
	0ddddddd deH	
	0ddddddd deL	
CHECK SUM	0eeeeeee ee	ee=(INVERT('L'+ 'M'+...+dsH+...+deL)+1) AND 7Fh
EOX	11110111 F7	End Of Exclusive

Dynamics library receive is effective for programs 41-128 only.

Dynamics Library Bulk Dump Request Format		
STATUS	11110000 F0	System Exclusive Message
ID No.	01000011 43	Manufacturer's ID (YAMAHA)
SUB STATUS	0010nnnn 2n	n=0-15(Tx/Rx Channel No.1-16)
FORMAT No.	01111110 7E	Universal Bulk Dump
	01001100 4C	'L'
	01001101 4D	'M'
	00100000 20	''
	00100000 20	''
	00111000 38	'8'
	01000001 41	'A'
	00110110 36	'6'
	00110111 37	'7'
DATA NAME	01011001 59	'Y'
	0mmmmmmm mm	m=0-127(Dynamics Library No.1-128)
EOX	11110111 F7	End Of Exclusive

Dynamics library transmission from the 02R is possible for programs 41-128 only.

Channel Library Bulk Dump Format		
STATUS	11110000 F0	System Exclusive Message
ID No.	01000011 43	Manufacturer's ID No.(YAMAHA)
SUB STATUS	0000nnnn 0n	n=0-15(Tx/Rx Channel No.1-16)
FORMAT No.	01111110 7E	Universal Bulk Dump

Channel Library Bulk Dump Format		
BYTE COUNT (HIGH/LOW)	00000000 00	122(48x2+16+10)bytes
	01111010 7A	
	01001100 4C	'L'
	01001101 4D	'M'
	00100000 20	''
	00100000 20	''
	00111000 38	'8'
	01000001 41	'A'
	00110110 36	'6'
	00110111 37	'7'
DATA NAME	01001000 48	'H'
	0mmmmmmm mm	m=0-63(Channel Library No.1-64)
DATA	0tttttttt tt	title1
	: :	:
	0tttttttt tt	title16
	0dsH	Channel Library Memory(48x2bytes)
	0dsL	
	: :	
	0deH	
0deL		
CHECK SUM	0eeeeeee ee	ee=(INVERT('L'+ 'M'+...+dsH+...+deL)+1) AND 7Fh
EOX	11110111 F7	End Of Exclusive

Channel Library Bulk Dump Request Format		
STATUS	11110000 F0	System Exclusive Message
ID No.	01000011 43	Manufacturer's ID (YAMAHA)
SUB STATUS	0010nnnn 2n	n=0-15(Tx/Rx Channel No.1-16)
FORMAT No.	01111110 7E	Universal Bulk Dump
	01001100 4C	'L'
	01001101 4D	'M'
	00100000 20	''
	00100000 20	''
	00111000 38	'8'
	01000001 41	'A'
	00110110 36	'6'
	00110111 37	'7'
DATA NAME	01001000 48	'H'
	0mmmmmmm mm	m=0-63(Channel Library No.1-64)

Channel Library Bulk Dump Request Format		
EOX	11110111 F7	End Of Exclusive
Automix Bulk Dump Format		
STATUS	11110000 F0	System Exclusive Message
ID No.	01000011 43	Manufacturer's ID No.(YAMAHA)
SUB STATUS	0000nnnn 0n	n=0-15(Tx/Rx Channel No.1-16)
FORMAT No.	01111110 7E	Universal Bulk Dump
BYTE COUNT (HIGH/LOW)	00010000 10	2078(1024x2+20+10)bytes
	00011110 1e	
	01001100 4C	'L'
	01001101 4D	'M'
	00100000 20	''
	00100000 20	''
	00111000 38	'8'
	01000001 41	'A'
	00110110 36	'6'
	00110111 37	'7'
DATA NAME	01000001 41	'A'
	0000mmmm 0m	m=0-15(Automix No.1-16)
DATA	0xxxxxxx xx	block count(High)
	0xxxxxxx xx	block count(Low) [0~size]
	0yyyyyyy yy	total size(High)
	0yyyyyyy yy	total size(Low)[size-1]
	0tttttttt tt	title1
	: :	:
	0tttttttt tt	title16
	0ddddddd dsH	Automix Memory(1024x2bytes)
	0ddddddd dsL	
	: :	
	0ddddddd deH	
0ddddddd deL		
CHECK SUM	0eeeeeee ee	ee=(INVERT('L'+ 'M'+...+dsH+...+deL)+1) AND 7Fh
EOX	11110111 F7	End Of Exclusive

Automix Bulk Dump Request Format		
STATUS	11110000 F0	System Exclusive Message
ID No.	01000011 43	Manufacturer's ID (YAMAHA)
SUB STATUS	0010nnnn 2n	n=0-15(Tx/Rx Channel No.1-16)
FORMAT No.	01111110 7E	Universal Bulk Dump
	01001100 4C	'L'
	01001101 4D	'M'
	00100000 20	''
	00100000 20	''
	00111000 38	'8'
	01000001 41	'A'
	00110110 36	'6'
	00110111 37	'7'
DATA NAME	01000001 41	'A'
	0000mmmm 0m	m=0-15(Automix No.1-16)
EOX	11110111 F7	End Of Exclusive

15

Glossary

A/D converter – The conversion of analog signals into digital signals. The analog signal is sampled every few milliseconds and its level is quantized into a digital word. The larger the digital word, the more accurate the representation of the analog value. See *Quantization* and *Sampling frequency*.

The 02R uses 20-bit linear analog-to-digital converters for most of its analog inputs.

Aliasing – A form of distortion which can occur during the conversion of analog signals into digital. If the input signal is more than one half the sampling rate, only portions of the signal will be present when the system samples the waveform. A false image of the waveform, based on the components that were actually sampled, is created.

A system which samples at 48 kHz can correctly process signals of up to 24 kHz. To remove signals above the Nyquist frequency (see *Nyquist Sampling Theorem*), all A/D converters employ anti-aliasing filters. The 02R employs over-sampling A/D converters to allow the anti-aliasing filter to be performed in the digital domain. See *over-sampling*.

Attenuation – After the signal has been converted to digital, the 02R can apply numerous forms of signal processing, such as equalization or effects. Some of these processes may boost the signal to digital clipping. The 02R allows you to attenuate the digital signal to reduce the chances of clipping.

Automation system – The 02R has an on-board automation system that memorizes fader positions, switches individual channels on or off, adjusts the equalization or pan positions, and changes the auxiliary sends – all based on timecode. It can recall scene memories and programs from the equalizer, effects, dynamics, and channel libraries, also determined by the recorded timecode. You can record an entire mixing session, and then edit the individual channel settings in multiple passes. You can punch-in to fine tune a specific parameter or you can use one of the event editors to adjust the timecode position of channel settings or scene and library changes.

Automix Memory – The automation system records each parameter change and the associated time as an event. The parameters that are recorded include fader movements, channel status and equalizer changes, and library recalls. The more complicated the mix, the more memory it consumes. The 02R has a default of 512 kbytes of automation memory.

Auxiliary send – The auxiliary sends are used to feed signals from the input or tape return channels to external effects processors, amplifiers, or multitrack recording equipment. The 02R has eight auxiliary sends. Two of the sends feed the internal effects processors. See *Internal Effects*.

Bit – A single unit of digital data. It can have a value of 1 or 0.

Bulk Dump – A MIDI function that allow the transfer of system specific data, such as sample files or mixer settings, between MIDI capable devices. The data are transmitted as MIDI System Exclusive messages.

Bus – A circuit that connects the input or tape and effect return signals with the output connectors. The 02R has eight output buses plus the stereo output.

Channel Library – An area in 02R memory used to access and store channel settings – stored as programs. There are 64 user programs for you to store your channel settings.

Compander – A compander is a compressor/expander – a combination of signal compression and expansion. The compander attenuates the input signal above the threshold as well as the level below the width. For very dynamic material, this program allows you to retain the dynamic range without having to be concerned with excessive output signal levels and clipping. See *Dynamics Processor*.

Compressor – A compressor provides a form of automatic level control. It attenuates high levels, thus effectively reducing the dynamic range, making it much easier to control signals and set appropriate fader levels. Reducing the dynamic range also means that recording levels can be set higher, therefore improving the signal-to-noise performance. Limiting is an extreme form of compression, where the output signal is sharply attenuated so that it cannot exceed a particular level. See *Dynamics Processor*.

Confidence monitoring – Listening directly from a recording medium to ensure the program material is being recorded correctly. Most analog recorders have a playback head trailing the record head, allowing you to hear the material directly after it has been recorded. Professional DAT recorders usually have four heads for confidence monitoring, as do a number of the modular digital multitrack recorders. Hard disk recorders offer their own form of confidence monitoring.

D/A converter – The conversion of a digital data stream into analog signals. The digital word is buffered and then converted into an analog signal. After conversion, the analog signal is usually processed through a smoothing filter which removes the step transitions between the digital words. The 02R uses 20-bit linear digital-to-analog converters for most of its analog outputs

DAT cassette – Metal chrome cassette tape (thickness 13µm, width 8.8mm).

Delay – A delay applied to the input signals processed by the 02R to compensate for signal processing delays, for example caused by the gap between the record and playback heads of a multitrack recorder.

Dither – Dithering is a mathematical process where a random noise is added to the least significant bit of a digital word. With very low level signals, the quantization error becomes correlated to the signal level. This creates a measurable amount of distortion. By adding dither, the correlation between the signal level and the quantization error is cancelled, allowing the digital system to encode amplitudes smaller than the least significant bit. If you change the word size as a signal passes from one digital system to another, being able to add dither allows you to maintain a high quality signal.

Digital Signal Processor (DSP) – A specialized circuit, usually a chip, that is designed to manipulate large quantities of data in real-time. YAMAHA has developed world renowned expertise in proprietary musical application specific digital signal processing.

Ducking – Ducking is used to automatically reduce signal levels when the level of a source signal exceeds a specified threshold. It is used for voice-over applications where, for example, level of background music is automatically reduced, allowing an announcer to be heard clearly. See *Dynamics Processor*.

Dynamic range – The difference between the loudest (maximum output level) and quietest (residual noise floor) sounds produced in an audio system. The dynamic range in a digital system is determined by the data resolution, about 6dB per digital bit. A 20-bit system has a theoretical dynamic range of 120 dB. The 02R has a specified dynamic range of 105 dB.

Dynamics Library – An area in 02R memory used to access and store dynamics settings – stored as programs. There are 40 preset programs (1 to 40) for you to recall and 88 user programs (41 to 128) for you to store your own dynamics settings.

Dynamics Processor – Dynamics processors are used to correct or control signal levels. The 02R features comprehensive dynamics processors for all the input channels, tape returns, and the bus and stereo outputs. These processors allow you to compress, expand, compress-expand (compand), gate, or duck the signals passing through the mixer. See *Compander*, *Compressor*, *Ducking*, *Expander*, and *Gate*.

Edit Buffer – The Edit Buffer is the current mix settings. When a scene memory is recalled, the mix settings of the selected scene memory are written to the Edit Buffer. When a scene memory is stored, the mix settings in the Edit Buffer are written to the selected scene memory.

Equalizer – The 02R is equipped with a four-band, fully parametric equalizer, with variable bandwidth (Q), center frequency (F), gain (G), and ON/OFF parameters. equalization can be applied to the input channels, the tape and effect return channels, and the stereo output. For stereo channels, the equalization curve is applied equally to both channels.

Equalizer Library – An area in 02R memory used to access and store equalizer settings – stored as programs. There are 40 preset programs (1 to 40) for you to recall and 88 user programs (41 to 128) for you to store your own equalizer settings.

Expander – An expander is another form of automatic level control. By attenuating the signal below the threshold, the expander reduces low-level noise or expands the dynamic range of the recorded material. See *Dynamics Processor*

F (frequency) – The center frequency of an equalizer band. See *Equalizer*.

Fader calibration – The motorized faders occasionally require re-calibration in order to maintain the highest performance possible.

G (gain) – The signal gain of an equalizer band. See *Equalizer*.

Gain and 20dB (pad) – The analog input pre-amplifier controls. These controls are used to optimize the signal from the input connectors. The pad switch is used to reduce the channel gain for line level signals.

Gate – A gate, or noise gate is an audio switch used to mute signals below a set threshold level. It can be used to suppress background noise and hiss from valve (tube) amps, effects pedals, and microphones. See *Dynamics Processor*.

IEC958 Part-2 (Consumer) – A digital interface protocol that is used to transfer digital audio data between consumer-type digital audio equipment such as CD players and DAT, DCC, and Mini Disc recorders. Two channels of digital audio (left/right) are carried on a single line. A coaxial phono/RCA jack connection is typical, but some systems use optical interconnects.

IEC958 Part-3 (AES/EBU - Professional) – A digital interface protocol that is used to transfer digital audio data between professional digital audio equipment such as PCM and DAT mastering recorders, modular multitrack recorders and other equipment. Two channels of digital audio are carried on a single line. An XLR-type connector and a shielded cable is typically used.

Internal Effects – The 02R is equipped with two internal multi-effects stereo processors. These processors have a startling range of special effects available to apply to your mix – shimmering reverbs, clean, precise delays, flanging and chorus, and a myriad of other effects are available.

Metering – The 02R features comprehensive signal level metering. The mono and stereo input channels, the tape and effect returns, and the auxiliary sends and buses are all metered using the METER display function. The control room output is metered using the dedicated 21-segment LED meters. Peak hold is available for all meters.

MIDI implementation – MIDI is an acronym for Musical Instrument Digital Interface. It is an international standard that allows electronic musical instruments to communicate with each other. Because of the complexity of the 02R, it only recognizes MIDI Program Change, Parameter Change, and System Exclusive messages. It uses System Exclusive messages to provide bulk data transfers as well as controller changes. It also reads MTC (MIDI timecode). See *Timecode*.

Modulation – Using a low frequency oscillator (LFO) to control a signal's frequency (pitch) or amplitude (level). The internal effects programs use modulation for a number of their programs. See *Internal Effects*.

Nyquist Sampling Theorem – This theorem defines the process of sampling audio with a digital system. Amongst other things, it states that the sampling frequency of a digital audio system must be at least twice that of the highest audio frequency, otherwise aliasing will occur. The Nyquist theorem was developed at Bell Labs by C. Shannon and H. Nyquist. See *Aliasing*.

over-sampling – The input analog signal is sampled at a much higher rate than the normal sampling rate. Using the high sample rate, the digital data may be processed with a very steep slope digital filter. As the filter is in the digital domain, unpleasant side-effects, such as phase effects are eliminated. The 02R uses 64-times over-sampling for most of its analog inputs and 8-times over-sampling for most of its analog outputs.

PCM – Pulse Code Modulation. A scheme for encoding audio data as a series of pulses. Each pulse defines a transition from binary one to binary zero.

Peaking – An equalizer circuit that is used to cut and boost a signal, centered about a specific frequency. Using the bandwidth (Q) parameter, you can widen or narrow the effect of the circuit.

Phase – Phase is the frequency coherence of a signal. If two signals are out of phase, the trough of the first waveform corresponds with the peak of the second, resulting in cancellation. The 02R can invert the phase of the input signals, which allows you to compensate for incorrectly wired conductors and so forth.

Program Change – A MIDI message that is used to recall programs. On the 02R they recall scene memories.

Q (bandwidth) – The bandwidth of an equalizer band. For high values the bandwidth is narrow. For low values, it is wide. See *Equalizer*.

Quantization – The encoding process when the analog input is approximated (quantized) to the nearest binary value available. In the 20-bit system of the 02R, pulses are approximated to one of 1,048,576 binary values. These approximations are not an exact duplication of the analog waveform and are therefore contain quantization errors (noise). However, this noise is reduced by over-sampling.

RAM (Random Access Memory) – A memory chip that stores data that can be edited and changed. It requires a continuous electrical charge. The 02R scenes memories and other libraries are stored in RAM. An internal backup battery provides the continuous charge. Contrast with *ROM*.

ROM (Read Only Memory) – A memory chip that stores data that cannot be edited. The 02R operating system is stored in ROM. Contrast with *RAM*.

Routing – The process of assigning input or tape and effect returns to the output buses or the stereo bus.

Sampling frequency – The rate at which measurements of an audio signal are taken during A/D and D/A conversion. Once in the digital domain, the data usually remains at the same sampling frequency. The measure is samples per second.

Scene Memory – The 02R scene memories are a memory location used to store a snapshot of virtually all the digital parameters of the mixer. Settings that are not stored consist mainly of monitor controls, analog controls, and switches. The 02R has 64 mix scene memory locations. Each can be named for easy identification.

Shelving – An equalizer circuit that is used to cut and boost a signal above or below a specified frequency. High and low band equalizers are usually shelving type. The 02R equalizer can be configured as shelving or peaking.

Signal to Noise ratio (S/N) – The difference between the nominal signal level and the residual noise floor, usually expressed in decibels.

System Exclusive – A MIDI message that is used to transmit data between MIDI devices that is exclusive to those devices. Bulk dump data can be sent from any device to a MIDI data file. Controller events are transmitted between 02Rs using System Exclusive messages. See also *Bulk Dump*.

Talkback System – A system that allows the engineer in the control room to talk to the musicians in the studio.

Timecode – Timecode is a signal that contains a chronological record of the absolute time in a recording. It is used for synchronizing different recorders. It can be used for electronic editing. Timecode was initially invented for the motion picture business, as a method of synchronizing the pictures recorded in the frames of a camera to the sound recorded on tape recorder.

The 02R supports three types of timecode, SMPTE timecode, MTC (MIDI timecode), and Internal timecode

White noise – A random noise that contains an equal amount of energy per frequency band. That is, 100–200, 800–900, and 3000–3100. Pink noise has an equal amount of energy per octave. The bands 100–200, 800–1600, and 3000–6000 all contain the same amount of energy.

Word – One sample of audio data. In the 02R, a word is 20-bits.

Wordclock – Wordclock is a sync pulse which allows devices to determine where the start of each digital word is. When multiple digital devices are connected together, it is vital that each device knows where a digital word starts and stops. Otherwise dropout or distortion may result. Although most digital interconnect protocols are self-clocking, it is more reliable to use a dedicated line for your wordclock signal. This is especially important in a multitrack environment where up to eight channels of digital data may be multiplexed on one cable.

References and Further Reading

- *Introducing Digital Audio*, Ian R Sinclair, second edition, PC Publishing, 1992.
- *Practical Recording Techniques*, Bruce and Jenny Bartlett, Sams, 1992.
- *Principles of Digital Audio*, Ken C. Pohlmann, Howard W.Sams & Co, 1989.
- *The Art of Digital Audio*, John Watkinson, Focal Press (Butterworth Group), 1990.
- *The MIDI Ins, Outs & Thrus*, Jeff Rona, Hal Leonard Publishing, 1992.
- *Yamaha Sound Reinforcement Handbook*, Gary Davis and Ralph Jones, second edition, Hal Leonard Publishing Corporation, 1990.

Index

A

- analog input connectors26
- attenuation, digital.....32
- automation system
 - current buffer125
 - description.....124
 - fader edit137
 - memory capacity124
 - memory contents.....124
 - naming an automix.....134
 - recall operation.....135
 - store operation.....134
 - timecode
 - internal timecode126
 - MTC connections127
 - MTC (MIDI) timecode.....127
 - SMPTE connections126
 - SMPTE timecode126
 - using the transport controls.....131
- AUTOMIX button128
- AUTOMIX display function
 - ABORT icon132
 - Automix Main screen
 - “Communication Speed” check boxes130
 - ENABLE (Automix) check box130
 - “Fader Edit Mode” check boxes.....131
 - “Frame” check boxes130
 - “INT Start Time” field130
 - “Overwrite” check boxes130
 - RETURN (Edit Out) check box131
 - “TC Input” check boxes130
 - Time Code display130
 - UNDO icon131
 - AUTOREC icon131
- Event Edit(CH ON) screen
 - Channel column139
 - DELETE icon.....139
 - INSERT icon.....139
 - ON/OFF column.....139
 - Time Code column.....139
- Event Edit(MEMORY) screen
 - Channel column138
 - DELETE icon.....138
 - INSERT icon.....138
 - Memory column.....138
 - Time Code column.....138
- Event Extract screen
 - channel icons.....140
 - EXTRACT icon140
 - “IN Time” field.....140
 - ONE/ALL – confirmation popup140
 - “Out Time” field.....140
 - “Parameters” check boxes140
 - popup – ALL icon140
 - popup – ONE icon140
- Fader Edit screen
 - “Fader Edit Mode” check boxes.....136
 - Fader Edit Out – Time field136
 - MOTOR ON icon136
 - RETURN check box136
- Memory Management screen
 - A.CLR (all clear) icon.....135
 - CLEAR icon.....135
 - COPY icon.....134
 - DEL. (delete) icon.....134
 - INS. (insert) icon.....134
 - NEW icon135
 - PASTE icon.....134
 - popup – CANCEL icon134
 - popup – EXECUTE icon.....134
 - RECALL – confirmation popup135
 - RECALL icon135
 - STORE – confirmation popup134
 - STORE icon134
 - UNDO icon135
- PLAY icon132
- REC (record) icon.....132
- STOP icon.....132
- also see *Getting Started Guide*
- auxiliary send
 - monitor mix88
- auxiliary sends
 - A-B comparisons87
 - description.....84
 - effects return84
 - fader status85
 - pre-fader or post-fader configuration87
 - send level control85
 - stereo input channels.....87
- AUX 1 button.....85
- AUX 1 display function
 - Mic/Line screen86
 - PRE/POST icon85

send level icon87
 send OFF indicator.....87
 Tape/Effect screen86
 AUX 5 button88
 AUX 7 button92
 AUX 7 display function
 Effect Edit screen
 level meters94
 LIB icon.....94
 parameter icons94
 Effect Library screen
 COPY icon96
 DEL. icon96
 INS. icon96
 level meters95
 LIB icon.....96
 PASTE icon.....96
 popup – CANCEL icon96
 popup – EXECUTE icon.....96
 program "U" (UNDO buffer).....97
 RECALL icon96
 STORE icon96
 STORE – confirmation popup96
 TITLE EDIT box.....95
 Mic/Line screen93
 PRE/POST icon92
 send level icon92
 send OFF indicator.....92
 Tape/Effect screen93
 also see *Getting Started Guide*

C

channel controls
 fader28
 FLIP button28
 ON button28
 rotary encoder28
 SEL button.....27
 channel library
 description.....47
 program name48
 recalling channel programs47
 storing channel programs47
 UNDO operation.....48
 CHANNEL library display function
 channel library store
 confirmation popup47
 popup – CANCEL icon47
 popup – EXECUTE icon.....48

COPY icon48
 DEL. (delete) icon.....48
 EXIT icon47
 INS. (insert) icon.....48
 PASTE icon.....48
 program "U" (UNDO buffer).....48
 RECALL icon48
 STORE icon47
 TITLE EDIT box.....47
 also see *VIEW display function*
 CONTROL ROOM group
 AUX5 button29
 AUX6 button.....29
 DIM button.....29
 MONO button29
 ST button29
 2TR IN analog
 2TR-A1 button29
 2TR-A2 button29
 2TR IN digital
 2TR-D1 button29
 2TR-D2 button29
 2TR-D3 button29
 also see *Monitor Mix*88
 controls
 analog input controls.....3
 analog output controls4
 DISPLAY ACCESS controls.....4
 display controls10
 display screen and related controls.....6
 faders.....9
 monitor controls8
 scene memory controls.....10
 SELECTED CHANNEL controls7
 C-R LEVEL control30
 CURSOR buttons.....20

D

delay
 cascade, and34
 description.....34
 fine-tuning.....35
 DELAY button34
 DELAY display function
 mSEC (milliseconds) field.....34
 OFF/ON (delay) icon34
 Smpl (sample) field34
 DIGITAL I/O button.....154
 DIGITAL I/O display function

Cascade Configuration screen	DYNAMICS	69
Attenuator icon.....	DYNAMICS Library	73
Cascade Aux Bus Assign check boxes	EQUALIZER	49
Cascade Input Attenuator icons	EQUALIZER Library	53
ENABLE check box.....	GROUP	148
ID field	METER.....	41
2TR-D2 to Stereo Bus controls.....	MIDI.....	142
Dither screen	PAIR.....	150
ON/OFF icon.....	PAN.....	36
Word Length icons.....	Ø/ATT.....	33
Input Signal Select screen	ROUTING	39
LINE17/18 icons	SCENE	117
LINE19/20 icons	SETUP	160
MIC1–8 icons	UTILITY	165
MIC9–16 icons	VIEW	44
Word Clock Select screen	dither.....	159
connection icons	DYNAMICS button	69
“Fs” box	DYNAMICS display function	
option slot icons	dynamics graph.....	71
wordclock select icons	GR (gain reduction) meter	71
DIM button (20 dB mute).....	IN prompt	70
DISPLAY ACCESS – AUX	KEY IN icons.....	72
AUX 1 button	KEY IN prompt	70
AUX 5 button	level meters	71
AUX 7 button	LINK icon.....	72
DISPLAY ACCESS – CONFIGURATION	ON/OFF icon.....	70
AUTOMIX button	ST.LINK prompt.....	70
DIGITAL I/O button.....	also see <i>Getting Started Guide</i>	
GROUP button	DYNAMICS Library display function	
MIDI button	COPY icon.....	74
PAIR button	DEL. icon.....	74
SCENE MEMORY button	dynamics library store	
SETUP button	confirmation popup.....	74
UTILITY button.....	popup – CANCEL icon	74
DISPLAY ACCESS – MIXING	popup – EXECUTE icon.....	74
DELAY button.....	INS. icon	74
DYNAMICS button	LIB icon.....	74
EQ button	PASTE icon.....	74
METER button.....	program "U" (UNDO buffer).....	75
PAN button.....	RECALL icon	74
Ø/ATT button.....	STORE icon	74
ROUTING button.....	TITLE EDIT box.....	73
VIEW button.....	also see <i>Getting Started Guide</i>	
display functions	dynamics processor	
AUTOMIX.....	compander	
AUX 1 to 6	description.....	66
AUX 7 and 8.....	parameters.....	66
CHANNEL library.....	compressor	
DELAY.....	description.....	63
DIGITAL I/O.....	parameters.....	63

description.....	62	L-MID box.....	50
ducking		LOW box.....	50
description.....	67	Q (bandwidth) icon.....	50
parameters.....	67	also see <i>Getting Started Guide</i>	
dynamics library.....	73	equalizer library	
dynamics programs		description.....	53
Compander – Hard (CPH).....	66	exiting the library.....	54
Compander – Soft (CPS).....	66	program name.....	55
Compressor (CMP).....	63	recalling EQ programs.....	53
Ducking (DUK).....	67	storing EQ programs.....	53
Expander (EXP).....	65	UNDO operation.....	55
Gate (GAT).....	67	EQUALIZER Library display function	
exiting the library.....	74	COPY icon.....	54
expander		DEL. icon.....	54
description.....	65	equalizer library store	
parameters.....	65	confirmation popup.....	54
gate		popup – CANCEL icon.....	54
description.....	67	popup – EXECUTE icon.....	54
parameters.....	67	INS. icon.....	54
program name.....	75	LIB icon.....	54
recalling dynamics programs.....	73	PASTE icon.....	54
storing dynamics programs.....	73	program "U" (UNDO buffer).....	55
UNDO operation.....	75	RECALL icon.....	54
		STORE icon.....	54
		TITLE EDIT box.....	53
E			
edit indicator.....	115	F	
effect return rotary encoder.....	28	factory default settings.....	170
effects		fader calibration.....	170
see <i>internal effects</i>		faders.....	28
also see <i>AUX 7 display function</i>		faders, grouping.....	148
encoder wheel.....	21	FADER STATUS indicator	
ENTER button.....	21	AUX LED.....	85
EQ button.....	49	AUX number.....	85
equalizer		FLIP button.....	28
default values.....	51		
description.....	49	G	
equalizer, resetting.....	51	gain	
gain, resetting.....	51	GAIN control.....	27
parameters.....	50	20dB (pad) switch.....	27
EQUALIZER display function		GAIN control.....	27
ATT control icon.....	49	graphical display screen.....	20
equalization curve.....	49	GROUP button.....	148
EQ ON icon.....	49	GROUP display function	
F (frequency) icon.....	50	Fader Group screen	
G (gain) icon.....	50	channel group icons.....	148
HIGH box.....	50	“Enable” group select icons.....	148
H-MID box.....	50	Mute Group screen	
level meters.....	49		
LIB icon.....	49		

channel group icons.....	149	EXECUTE icons.....	146
“Enable” group select icons.....	149	NUMBER field.....	145
I			
input controls		PGM TABLE icon.....	145
gain.....	27	REQUEST ALL icon.....	146
pad.....	27	SCENE MEM icon.....	145
phantom power.....	26	SETUP icon.....	145
installing 02R options		STATUS field.....	146
double slot cards.....	176	TYPE icons.....	145
memory expansion kit.....	177	MIDI Program Change Assign screen	
peak meter bridge.....	177	Program Change Assign table.....	144
single slot cards.....	175	TABLE RESET icon.....	144
wooden side panels.....	177	UNDO icon.....	144
internal effects		MIDI Setup screen	
auxiliary sends.....	92	Echo – “Program Change” icon.....	143
description.....	90	Omni – “Program Change” icon.....	143
exiting the library.....	96	“Parameter Chg.” icon.....	143
program name.....	97	“Program Change” icon.....	143
recalling effects programs.....	95	Receive Channel icons.....	143
storing effects programs.....	95	Transmit Channel icons.....	143
UNDO operation.....	97	MIDI implementation	
M			
METER button.....	41	aborting a bulk dump.....	146
METER display function		bulk dump/request.....	145
PEAK HOLD icon.....	41	description.....	142
POST EQ icon.....	41	Program Change messages.....	142
POST FADER icon.....	41	recalling scene memories.....	144
PRE EQ icon.....	41	set-up.....	143
also see <i>Getting Started Guide</i>		System Exclusive messages.....	142
metering		monitor mix.....	88
description.....	41	MONO button.....	29
optional meter bridge – MB02.....	43	MTC (MIDI) timecode	
peak hold.....	42	see <i>automation system</i>	
source points.....	42	O	
MIDI button.....	143	ON button.....	28
MIDI data format.....	206–223	ON button, grouping.....	149
MIDI display function		options	
MIDI Bulk Dump & Request screen		Analog I/O Card	
AUTOMIX icon.....	145	AD/DA (CD8-AD).....	173
BULK DUMP icon.....	146	Analog I/O Card – AD/DA (CD8-AD)	
BULK REQUEST icon.....	146	installing.....	178
CH LIB icon.....	145	setup.....	178
DUMP ALL icon.....	146	Digital Cascade Kit (CD8-CS).....	173
DY. LIB icon.....	145	cascade settings.....	185
EFF LIB icon.....	145	installing.....	183
EQ LIB icon.....	145	solo function.....	186
		wordclock selection.....	184
		Digital I/O Card	
		ADAT (CD8-AT).....	173
		AES/EBU (CD8-AE/CD8-AE-S).....	173

Emphasis indicator	167
Fs indicator.....	167
SLOT1 icon.....	167
SLOT2 icon.....	167
SLOT3 icon.....	167
SLOT4 icon.....	167
2TR icon.....	167
Emphasis Monitor screen.....	166
Oscillator screen	
Aux Assign icons.....	165
BUS Assign icons	165
Level rotary icon	165
ON/OFF icon.....	165
Stereo Assign icon.....	165
Wave Form icons.....	165

V

VIEW button	44
VIEW display function	
auxiliary send icons	
AUX1 to 8 icons	46
PRE/POST icon.....	46
channel library	
also see <i>CHANNEL Library display function</i>	
DELAY controls	
mSEC (milliseconds) field.....	45
OFF/ON (delay) icon	45
Smpl (sample) field.....	45
DYNAMICS controls	
dynamics curve icon.....	46
ON/OFF (DYNAMICS) icon.....	46
EFFECT TYPE icon	46
EQ controls	
equalizer curve icon.....	46
ON/OFF (EQ) icon	46
fader position icon	45
F (fader group) icons	45
level meters	45
LIB (library) icon	46
M (mute group) icons.....	45
ON (channel) icon	45
PAIR icon.....	45
PAN control icon.....	44
∅/ATT controls	
ATT control icon.....	44
NOR/REV (phase) icon	44
PRE EQ/POST EQ/POST FADER icon.....	45
ROUTING icons	45
also see <i>Getting Started Guide</i>	

W

wordclock	
definition of.....	154
indicators.....	155

Function...		Transmitted	Recognized	Remarks
Basic Channel	Default Changed	1-16 1-16	1-16 1-16	Memorized
Mode	Default Messages Altered	x x *****	OMNI off/OMNI on x x	Memorized
Note Number	: True voice	x *****	x x	
Velocity	Note ON Note OFF	x x	x x	
After Touch	Key's Ch's	x x	x x	
Pitch Bend		x	x	
Control Change		x	x	
Prog Change	: True #	o 0 - 127 *****	o 0 - 127 0 - 64	*1
System Exclusive		o	o	*2
Common	: Song Pos : Song Sel : Tune	x x x	x x x	
System Real Time	: Clock : Commands	x x	x x	
Aux Messages	: Local ON/OFF : All Notes OFF : Active Sense : Reset	x x o x	x x x x	
Notes	MTC quarter frame message is recognized (MTC IN) *1 : For program 1 - 128, memory #0 - #64 is selected. *2 : Bulk Dump/Request and Parameter Change/Request			

Mode 1:OMNI ON,POLY
 Mode 3:OMNI OFF,POLY

Mode 2:OMNI ON,MONO
 Mode 4:OMNI OFF,MONO

o:Yes
 x:No

User Setting Sheet

PROJECT	DATE	SCENE	AUTOMIX													
MIC/LINE																
A/B	1	2	3	4	5	6	7	8	9	10	11	12	13	14	15	16
20dB	<input type="checkbox"/> A <input type="checkbox"/> B <input type="checkbox"/> OFF <input type="checkbox"/> ON	<input type="checkbox"/> A <input type="checkbox"/> B <input type="checkbox"/> OFF <input type="checkbox"/> ON	<input type="checkbox"/> A <input type="checkbox"/> B <input type="checkbox"/> OFF <input type="checkbox"/> ON	<input type="checkbox"/> A <input type="checkbox"/> B <input type="checkbox"/> OFF <input type="checkbox"/> ON	<input type="checkbox"/> A <input type="checkbox"/> B <input type="checkbox"/> OFF <input type="checkbox"/> ON	<input type="checkbox"/> A <input type="checkbox"/> B <input type="checkbox"/> OFF <input type="checkbox"/> ON	<input type="checkbox"/> A <input type="checkbox"/> B <input type="checkbox"/> OFF <input type="checkbox"/> ON	<input type="checkbox"/> A <input type="checkbox"/> B <input type="checkbox"/> OFF <input type="checkbox"/> ON	<input type="checkbox"/> OFF <input type="checkbox"/> ON	<input type="checkbox"/> OFF <input type="checkbox"/> ON	<input type="checkbox"/> OFF <input type="checkbox"/> ON	<input type="checkbox"/> OFF <input type="checkbox"/> ON	<input type="checkbox"/> OFF <input type="checkbox"/> ON	<input type="checkbox"/> OFF <input type="checkbox"/> ON	<input type="checkbox"/> OFF <input type="checkbox"/> ON	<input type="checkbox"/> OFF <input type="checkbox"/> ON
GAIN																
INST.																
LINE																
GAIN	17	18	19	20	21	22	23	24	AUX							
INST.									1	2	3	4	5	6		
									TAPE							
TRACK	1	2	3	4	5	6	7	8	9	10	11	12	13	14	15	16
TRACK	1	2	3	4	5	6	7	8	9	10	11	12	13	14	15	16

YAMAHA